



HIRSCHMANN

A **BELDEN** BRAND

Anwender-Handbuch

Konfiguration

Lite Managed Switch

Lite Managed Switch GECKO 4TX

Die Nennung von geschützten Warenzeichen in diesem Handbuch berechtigt auch ohne besondere Kennzeichnung nicht zu der Annahme, dass solche Namen im Sinne der Warenzeichen- und Markenschutz-Gesetzgebung als frei zu betrachten wären und daher von jedermann benutzt werden dürften.

© 2021 Hirschmann Automation and Control GmbH

Handbücher sowie Software sind urheberrechtlich geschützt. Alle Rechte bleiben vorbehalten. Das Kopieren, Vervielfältigen, Übersetzen, Umsetzen in irgendein elektronisches Medium oder maschinell lesbare Form im Ganzen oder in Teilen ist nicht gestattet. Eine Ausnahme gilt für die Anfertigungen einer Sicherungskopie der Software für den eigenen Gebrauch zu Sicherungszwecken.

Die beschriebenen Leistungsmerkmale sind nur dann verbindlich, wenn sie bei Vertragsschluss ausdrücklich vereinbart wurden. Diese Druckschrift wurde von Hirschmann Automation and Control GmbH nach bestem Wissen erstellt. Hirschmann behält sich das Recht vor, den Inhalt dieser Druckschrift ohne Ankündigung zu ändern. Hirschmann gibt keine Garantie oder Gewährleistung hinsichtlich der Richtigkeit oder Genauigkeit der Angaben in dieser Druckschrift.

Hirschmann haftet in keinem Fall für irgendwelche Schäden, die in irgendeinem Zusammenhang mit der Nutzung der Netzkomponenten oder ihrer Betriebssoftware entstehen. Im Übrigen verweisen wir auf die im Lizenzvertrag genannten Nutzungsbedingungen.

Die jeweils neueste Version dieses Handbuches finden Sie im Internet auf den Hirschmann-Produktseiten (www.hirschmann.com).

Hirschmann Automation and Control GmbH
Stuttgarter Str. 45-51
72654 Neckartenzlingen
Deutschland

Inhalt

Sicherheitshinweise	9
Über dieses Handbuch	10
Legende	11
Einleitung	13
1 IP-Parameter festlegen	15
1.1 IP-Parameter über DHCP festlegen (Lieferzustand)	16
1.2 IP-Parameter über HiDiscovery festlegen	17
1.3 IP-Parameter über die grafische Benutzeroberfläche festlegen	19
1.4 IP-Parameter über BOOTP festlegen	21
2 Zugriff auf das Gerät	23
2.1 Erste Anmeldung (Passwortänderung)	24
2.2 Grafische Benutzeroberfläche starten	27
3 Konfiguration laden/speichern	29
3.1 Konfiguration in den Lieferzustand zurücksetzen	30
3.2 Konfiguration importieren	31
3.3 Konfiguration im Gerät speichern	33
3.4 Konfiguration exportieren	34
4 Stand der Software prüfen/Software aktualisieren	35
4.1 Stand der Software prüfen	36
4.2 Software aktualisieren	37

5	Ports konfigurieren	39
5.1	Port aus-/einschalten	40
5.2	Betriebsmodus wählen	41
5.3	Link-Überwachung (Alarmmeldungen) ein-/ausschalten	42
6	Unterstützung beim Schutz vor unberechtigten Zugriffen	43
6.1	Passwörter ändern	44
6.2	HiDiscovery-Zugriff aus-/einschalten	46
6.3	SNMP-Zugriff anpassen	47
6.3.1	Community für Lese-/Schreibzugriffe ändern	48
6.3.2	Zugriff über SNMPv1 oder SNMPv2 im Gerät ausschalten	49
6.3.3	Zugriff über SNMPv3 im Gerät einschalten	49
7	Netzlaststeuerung	51
7.1	Gezielte Paketvermittlung	52
7.1.1	Lernen der MAC-Adressen	52
7.1.2	Aging gelernter MAC-Adressen	53
7.1.3	Statische Adresseinträge erzeugen	53
7.1.4	Gelernte Adresseinträge löschen	54
7.2	Priorisieren des Datenverkehrs (Quality of Service)	55
7.2.1	Priorisierung einstellen	55
8	Diagnose	57
8.1	Alarme (Traps) einstellen	58
8.2	Topologie-Erkennung anzeigen	60
8.3	System-Log	61

9	Unterstützung beim sicheren Fernzugriff	63
9.1	SiteManager GECKO	64
9.1.1	SiteManager GECKO konfigurieren	64
10	Redundanzverfahren Rapid Spanning Tree Protocol konfigurieren	69
11	Referenzen	71
11.1	Grundeinstellungen	72
11.1.1	Grundeinstellungen > System	72
11.1.2	Grundeinstellungen > Netz	73
11.1.3	Grundeinstellungen > Software	77
11.1.4	Grundeinstellungen > Laden/Speichern	78
11.1.5	Grundeinstellungen > Port > Konfiguration	80
11.1.6	Grundeinstellungen > Port > Statistiken	82
11.2	Gerätesicherheit	84
11.2.1	Gerätesicherheit > Passwort	84
11.2.2	Gerätesicherheit > HTTPS	86
11.2.3	Gerätesicherheit > SNMP	89
11.3	Zeit	92
11.3.1	Zeit> Grundeinstellungen	92
11.3.2	Zeit> SNTP	93
11.4	Switching	98
11.4.1	Switching > Filter für MAC-Adressen	98
11.4.2	QoS/Priorität	100
11.4.3	Switching > QoS/Priorität > Port-Konfiguration	100
11.4.4	Switching > QoS/Priorität > 802.1D/p-Mapping	103
11.4.5	QoS/Priorität > IP-DSCP-Mapping	105
11.4.6	Switching> VLAN	106
11.4.7	Switching> VLAN> Konfiguration	107
11.4.8	Switching> VLAN> Port	109
11.4.9	Switching > L2 Redundancy > Spanning Tree > Global	111
11.4.10	Switching > L2-Redundanz > Spanning Tree > Port	115

11.5	Secure Remote Access	119
9.1	Secure Remote Access> SiteManager GECKO	64
11.5.2	Secure Remote Access > About	122
11.6	Diagnose	124
11.6.1	Diagnose >Alarme (Traps)	124
11.6.2	Diagnose > LLDP	126
11.6.3	Diagnose > System Log	128
11.6.4	Diagnose > Syslog	129
11.7	Erweitert	131
11.7.1	Erweitert> Industrieprotokolle> PROFINET	131
11.7.2	Schaltflächen	133
A	Anhang	135
A.1	Technische Daten	136
A.2	Zugrundeliegende technische Normen	137
A.3	Liste der RFCs	138
A.4	Literaturhinweise	140
A.5	Grundlagen IP-Parameter	141
A.5.1	IP-Adresse (Version 4)	141
A.5.2	Netzmaske	142
A.5.3	Classless Inter-Domain Routing	145
A.6	Grundlagen Dynamic Host Configuration Protocol (DHCP)	147
A.7	Grundlagen Spanning-Tree-Protokoll	149
A.7.1	Grundlagen	150
A.7.2	Regeln für die Erstellung der Baumstruktur	155
A.7.3	Beispiele	158
A.7.4	Das Rapid Spanning Tree Protokoll	163
A.8	Grundlagen Topologie-Erkennung	169
A.9	Grundlagen Priorisierung des Datenverkehrs	171
A.9.1	Beschreibung Priorisierung	171
A.9.2	Behandlung empfangener Prioritätsinformationen	172
A.9.3	VLAN-Tagging	173
A.9.4	Handhabung der Verkehrsklassen	175

A.10	Grundlagen Flusskontrolle	176
A.10.1	Halbduplex- oder Vollduplex-Verbindung	177
A.11	Grundlagen Management Information BASE (MIB)	179
A.12	Copyright integrierter Software	181
A.12.1	Included open source software	181
A.12.2	ICS DHCP	201
A.12.3	curl	202
A.12.4	expat	203
A.12.5	libevent	203
A.12.6	json-c	205
A.12.7	LUA	206
A.12.8	sprintf.js	207
A.12.9	Flexigrid	207
A.12.10	jquery	208
A.12.11	mootools, mootools-more	209
A.12.12	NetSNMP	210
A.12.13	openssl	217
A.12.14	ncurses	220
A.12.15	XZ Utils	221
A.12.16	utils-linux-ng	222
A.13	Abkürzungen	334
B	Leserkritik	336
C	Weitere Unterstützung	339

Sicherheitshinweise



WARNUNG

UNKONTROLLIERTE MASCHINENBEWEGUNGEN

Um unkontrollierte Maschinenbewegungen aufgrund von Datenverlust zu vermeiden, konfigurieren Sie alle Geräte zur Datenübertragung individuell. Nehmen Sie eine Maschine, die mittels Datenübertragung gesteuert wird, erst in Betrieb, wenn Sie alle Geräte zur Datenübertragung vollständig konfiguriert haben.

Das Nichtbeachten dieser Anweisung kann zu Tod, schwerer Körperverletzung oder Materialschäden führen.

Über dieses Handbuch

Die Dokumentation zu Ihrem Gerät besteht aus folgenden Dokumenten.

Montageanleitung	Dieses Dokument enthält Sicherheitshinweise und Informationen, die Sie zur Montage des Gerätes benötigen.
Anwender-Handbuch Installation	Dieses Dokument enthält eine Gerätebeschreibung, Sicherheitshinweise und weitere Informationen, die Sie zur Installation des Gerätes benötigen, bevor Sie mit der Konfiguration des Gerätes beginnen.
Anwender-Handbuch Konfiguration	Dieses Dokument enthält die Informationen, die Sie zur Inbetriebnahme des Gerätes benötigen. Es leitet Sie Schritt für Schritt von der ersten Inbetriebnahme bis zu den grundlegenden Einstellungen für einen Ihrer Umgebung angepassten Betrieb.
Online-Hilfe	Die Online-Hilfe enthält Beschreibungen der einzelnen Parameter, die Sie über die grafische Benutzeroberfläche konfigurieren. Rufen Sie die Online-Hilfe über die Schaltfläche „Hilfe“ in der grafischen Benutzeroberfläche auf. Die Inhalte der Online-Hilfe entsprechen den Informationen im Kapitel „Referenzen“ im Anwender-Handbuch Konfiguration.

Die Dokumentation, die Ihrem Gerät nicht in ausgedruckter Form beiliegt, finden Sie als PDF-Datei unter „Downloads“ unter



www.hirschmann.com/de/QR/INET-GECKO4TX_de-HB.

Die Netzmanagement-Software Industrial HiVision bietet Ihnen Möglichkeiten zur komfortablen Konfiguration und Überwachung. Weitere Informationen finden Sie im Internet auf den Hirschmann-Produktseiten:

<http://www.hirschmann.com/de/QR/INET-Industrial-HiVision>

Legende

Verwendete Auszeichnungen:

	Aufzählung
<input data-bbox="150 386 169 408" type="checkbox"/>	Arbeitsschritt
	Zwischenüberschrift
Link	Querverweis mit Verknüpfung
Anmerkung:	Eine Anmerkung betont eine wichtige Tatsache oder lenkt Ihre Aufmerksamkeit auf eine Abhängigkeit.
<code>Courier</code>	ASCII-Darstellung in Bedienoberfläche

Einleitung

Das Gerät ist für die Praxis in der rauen Industrieumgebung entwickelt. Dementsprechend einfach ist die Installation. Mit wenigen Einstellungen können Sie dank der gewählten Voreinstellungen das Gerät sofort in Betrieb nehmen.

Anmerkung: Geänderte Einstellungen speichert das Gerät im flüchtigen Arbeitsspeicher, wenn Sie auf „Schreiben“ klicken. Über den Dialog *Grundeinstellungen* > *Laden/Speichern* speichern Sie geänderte Einstellungen nicht-flüchtig im lokalen Speicher des Gerätes.

1 IP-Parameter festlegen

Anmerkung: Hintergrundinformation zu diesem Thema bietet Ihnen [„Grundlagen IP-Parameter“ auf Seite 141](#).

Um das Gerät bei der Erstinstallation über das Netz zu erreichen, benötigen Sie die IP-Parameter des Gerätes.

Das Gerät bietet Ihnen folgende Möglichkeiten, IP-Parameter festzulegen:

- ▶ [IP-Parameter über DHCP festlegen \(Lieferzustand\)](#)
Hierzu benötigen Sie einen DHCP-Server. Der DHCP-Server weist dem Gerät anhand seiner MAC-Adresse oder seines Systemnamens die IP-Parameter zu.
- ▶ [IP-Parameter über HiDiscovery festlegen](#)
Wählen Sie diese Methode für ein bereits installiertes Netzgerät oder wenn eine weitere Ethernet-Verbindung zwischen Ihrem PC und dem Gerät besteht.
- ▶ [IP-Parameter über BOOTP festlegen](#)
Hierzu benötigen Sie einen BOOTP-Server. Der BOOTP-Server weist dem Gerät anhand seiner MAC-Adresse die IP-Parameter zu.
- ▶ [IP-Parameter über die grafische Benutzeroberfläche festlegen](#)
Wählen Sie diese Methode, wenn Ihr Gerät bereits über eine IP-Adresse verfügt und über das Netz erreichbar ist.

1.1 IP-Parameter über DHCP festlegen (Lieferzustand)

Anmerkung: Hintergrundinformation zu diesem Thema bietet Ihnen [„Grundlagen Dynamic Host Configuration Protocol \(DHCP\)“](#) auf Seite 147.

Voraussetzung:

- ▶ Sie benötigen einen DHCP-Server. Der DHCP-Server weist dem Gerät anhand seiner MAC-Adresse oder seines Systemnamens die IP-Parameter zu.

Im Lieferzustand ist die Festlegung der IP-Parameter über einen DHCP-Server aktiviert. Das Gerät versucht, von einem DHCP-Server eine IP-Adresse zu beziehen.

Bleibt die Antwort des DHCP-Servers aus, setzt das Gerät die IP-Adresse auf 0.0.0.0 und versucht erneut, eine gültige IP-Adresse zu erhalten.

Um die Festlegung der IP-Parameter über einen DHCP-Server zu aktivieren oder zu deaktivieren, ändern Sie im Dialog **Grundeinstellungen > Netz** im Rahmen „Management-Schnittstelle“ die Quelle, aus welcher das Gerät seine IP-Parameter bezieht.

1.2 IP-Parameter über HiDiscovery festlegen

Das HiDiscovery-Protokoll ermöglicht Ihnen, dem Gerät über das Ethernet IP-Parameter zuzuweisen.

Installieren Sie die HiDiscovery-Software auf Ihrem PC. Sie finden die Software auf den Hirschmann-Produktseiten zum Download.

- Starten Sie das Programm HiDiscovery.

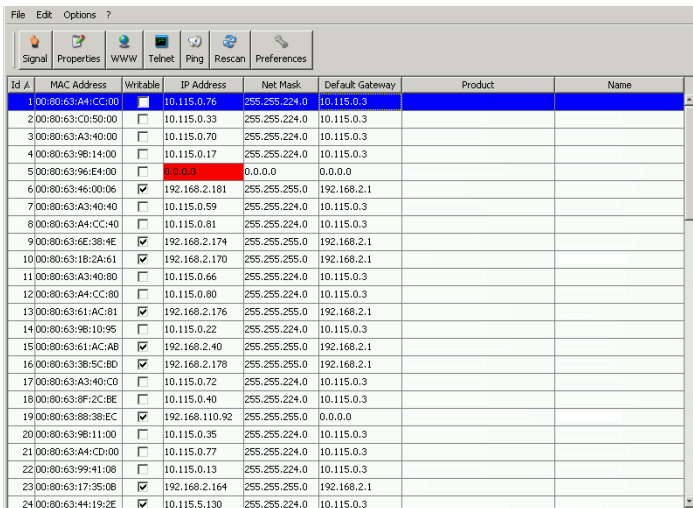

ID	MAC Address	Writable	IP Address	Net Mask	Default Gateway	Product	Name
1	00:80:63:A4:CC:00	<input checked="" type="checkbox"/>	10.115.0.76	255.255.224.0	10.115.0.3		
2	00:80:63:C0:50:00	<input type="checkbox"/>	10.115.0.33	255.255.224.0	10.115.0.3		
3	00:80:63:A3:40:00	<input type="checkbox"/>	10.115.0.70	255.255.224.0	10.115.0.3		
4	00:80:63:9B:14:00	<input type="checkbox"/>	10.115.0.17	255.255.224.0	10.115.0.3		
5	00:80:63:96:E4:00	<input type="checkbox"/>	0.0.0.0	0.0.0.0	0.0.0.0		
6	00:80:63:46:00:06	<input checked="" type="checkbox"/>	192.168.2.181	255.255.255.0	192.168.2.1		
7	00:80:63:A3:40:40	<input type="checkbox"/>	10.115.0.59	255.255.224.0	10.115.0.3		
8	00:80:63:A4:CC:40	<input type="checkbox"/>	10.115.0.81	255.255.224.0	10.115.0.3		
9	00:80:63:6E:38:4E	<input checked="" type="checkbox"/>	192.168.2.174	255.255.255.0	192.168.2.1		
10	00:80:63:1B:2A:61	<input checked="" type="checkbox"/>	192.168.2.170	255.255.255.0	192.168.2.1		
11	00:80:63:A3:40:80	<input type="checkbox"/>	10.115.0.66	255.255.224.0	10.115.0.3		
12	00:80:63:A4:CC:80	<input type="checkbox"/>	10.115.0.80	255.255.224.0	10.115.0.3		
13	00:80:63:61:AC:81	<input checked="" type="checkbox"/>	192.168.2.176	255.255.255.0	192.168.2.1		
14	00:80:63:9B:10:95	<input type="checkbox"/>	10.115.0.22	255.255.224.0	10.115.0.3		
15	00:80:63:61:AC:AB	<input checked="" type="checkbox"/>	192.168.2.40	255.255.255.0	192.168.2.1		
16	00:80:63:3B:5C:BD	<input checked="" type="checkbox"/>	192.168.2.178	255.255.255.0	192.168.2.1		
17	00:80:63:A3:40:C0	<input type="checkbox"/>	10.115.0.72	255.255.224.0	10.115.0.3		
18	00:80:63:0F:2C:BE	<input type="checkbox"/>	10.115.0.40	255.255.224.0	10.115.0.3		
19	00:80:63:88:38:EC	<input checked="" type="checkbox"/>	192.168.110.92	255.255.255.0	0.0.0.0		
20	00:80:63:9B:11:00	<input type="checkbox"/>	10.115.0.35	255.255.224.0	10.115.0.3		
21	00:80:63:A4:CD:00	<input type="checkbox"/>	10.115.0.77	255.255.224.0	10.115.0.3		
22	00:80:63:99:41:08	<input type="checkbox"/>	10.115.0.13	255.255.224.0	10.115.0.3		
23	00:80:63:17:35:0B	<input checked="" type="checkbox"/>	192.168.2.164	255.255.255.0	192.168.2.1		
24	00:80:63:44:19:2E	<input checked="" type="checkbox"/>	10.115.5.130	255.255.224.0	10.115.0.3		

Abb. 1: HiDiscovery

Beim Start von HiDiscovery untersucht HiDiscovery automatisch das Netz nach Geräten, die das HiDiscovery-Protokoll unterstützen.

HiDiscovery benutzt das erste gefundene Netz-Interface des PCs. Sollte Ihr Rechner über mehrere Netzwerkkarten verfügen, können Sie das gewünschte in der Werkzeugleiste von HiDiscovery auswählen.

HiDiscovery zeigt für jedes Gerät, das auf das HiDiscovery-Protokoll reagiert, eine Zeile an.

HiDiscovery ermöglicht das Identifizieren der angezeigten Geräte.

- Wählen Sie eine Gerätezeile aus.
- Klicken Sie auf das „Signal“-Symbol in der Werkzeugleiste, um das Blinken der LEDs des ausgewählten Gerätes einzuschalten. Ein weiteres Klicken auf das Symbol schaltet das Blinken aus.
- Mit einem Doppelklick auf eine Zeile öffnen Sie ein Fenster, in dem Sie den Gerätenamen und die IP-Parameter eintragen können.



Abb. 2: HiDiscovery – IP-Parameter-Zuweisung

Anmerkung: Schalten Sie aus Sicherheitsgründen im Graphical User Interface die HiDiscovery-Funktion des Gerätes aus, nachdem Sie dem Gerät die IP-Parameter zugewiesen haben.

[Siehe „HiDiscovery-Zugriff aus-/einschalten“ auf Seite 46.](#)

Anmerkung: Damit die Eingaben nach einem Neustart wieder zur Verfügung stehen, speichern Sie die Einstellungen über den Dialog „Laden/Speichern“ im lokalen nicht-flüchtigen Speicher des Gerätes .

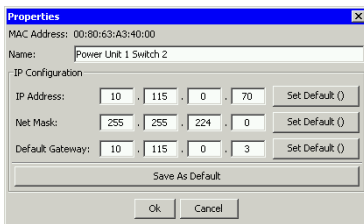
1.3 IP-Parameter über die grafische Benutzeroberfläche festlegen

Voraussetzung:

- ▶ Ihr Gerät verfügt bereits über eine IP-Adresse und ist über das Netz erreichbar.

Vorgehen:

- Öffnen Sie den Dialog `Grundeinstellungen > Netz`.
- Legen Sie im Rahmen „IP-Parameter“ die IP-Parameter des Gerätes fest:

Parameter	Bedeutung
IP-Adresse	<p>Legt die IP-Adresse fest, unter der das Management des Gerätes über das Netz erreichbar ist.</p> <p>Mögliche Werte:</p> <ul style="list-style-type: none"> ▶ Gültige IPv4-Adresse (Voreinstellung: —)
Netzmaske	<p>Legt die Netzmaske fest. Die Netzmaske kennzeichnet in der IP-Adresse das Netzpräfix und die Host-Adresse des Gerätes.</p> <p>Mögliche Werte:</p> <ul style="list-style-type: none"> ▶ Gültige IPv4-Netzmaske (Voreinstellung: —)
Gateway-Adresse	<p>Legt die IP-Adresse eines Routers fest, über den das Gerät andere Geräte außerhalb des eigenen Netzes erreicht.</p> <p>Mögliche Werte:</p> <ul style="list-style-type: none"> ▶ Gültige IPv4-Adresse (Voreinstellung: —)

- Um die Änderungen flüchtig zu speichern, klicken Sie „Schreiben“.

Anmerkung: Damit die Eingaben nach einem Neustart wieder zur Verfügung stehen, speichern Sie die Einstellungen über den Dialog „Laden/Speichern“ im lokalen nicht-flüchtigen Speicher des Gerätes .

1.4 IP-Parameter über BOOTP festlegen

Voraussetzung:

- ▶ Hierzu benötigen Sie einen BOOTP-Server. Der BOOTP-Server weist dem Gerät anhand seiner MAC-Adresse die IP-Parameter zu.

Vorgehen:

- Öffnen Sie den Dialog *Grundeinstellungen > Netz*.
- Um die Zuweisung der IP-Parameter durch einen BOOTP-Server zu aktivieren, wählen Sie im Rahmen „Management-Schnittstelle“ den Wert BOOTP.

Bei aktivierter BOOTP-Funktion sendet das Gerät eine Boot-Anforderungsnachricht an den BOOTP-Server. Der Server antwortet mit einer Boot-Antwort-Nachricht. Die Boot-Antwort-Nachricht enthält die zugewiesene IP-Adresse.

Bleibt die Antwort des BOOTP-Servers aus, setzt das Gerät die IP-Adresse auf 0.0.0.0 und versucht erneut, eine gültige IP-Adresse zu erhalten.

2 Zugriff auf das Gerät

2.1 Erste Anmeldung (Passwortänderung)

Um unerwünschte Zugriffe auf das Gerät zu verhindern, ist es unerlässlich, dass Sie das voreingestellte Passwort bei der ersten Anmeldung ändern.

Das Gerät bietet Ihnen die folgenden Methoden, zur Änderung des Passworts.

- Öffnen Sie die grafische Benutzeroberfläche, oder das Command Line Interface, wenn Sie sich zum ersten Mal am Gerät anmelden.
- Melden Sie sich am Gerät mit dem voreingestellten Passwort an. Das Gerät fordert Sie auf, ein neues Passwort einzugeben.
- Geben Sie Ihr neues Passwort ein.
Um die Sicherheit zu erhöhen, wählen Sie ein Passwort mit mindestens 8 Zeichen, das Großbuchstaben, Kleinbuchstaben, numerische Ziffern und Sonderzeichen enthält.
- Bestätigen Sie Ihr neues Passwort
- Klicken Sie die Schaltfläche **OK**.
- Das Gerät zeigt einen Dialog an, der Sie darüber informiert, dass sich das Kennwort geändert hat. Klicken Sie die Schaltfläche **OK**.
- Melden Sie sich mit Ihrem neuen Passwort erneut am Gerät an.

Parameter	Bedeutung
Passwort	Das voreingestellte Passwort ist <code>private</code> .
Neues Passwort (1)	Geben Sie Ihr neues Passwort ein. Mögliche Werte: ▶ a-z, A-Z ▶ <code>#\$%&#()*+,-./:;<=>@[!^_`{}~! </code>
Neues Passwort (2)	Bestätigen Sie Ihr neues Passwort
Sprache	Wählen Sie eine 'Dialog-Sprache':

Weitere Informationen finden Sie unter: hirschmann-support.belden.com

Abb. 3: Erste Anmeldung-Dialog

In den folgenden Tabellen sind die Voreinstellungen der Protokolle aufgeführt.

Protokoll	Voreinstellung
SNMP v1	Deaktiviert
SNMP v2	Deaktiviert
SNMP v3	Deaktiviert
CLI SSH	Aktiviert
CLI Telnet	Deaktiviert
CLI V.24/USB	Aktiviert
MOPS BASIC Auth	Deaktiviert
MOPS MOPS Auth	Aktiviert
HTTP(S)	Aktiviert
DHCP	Aktiviert
SNMP über HTTP(S)	Aktiviert

Tab. 1: Management-Protokolle

Protokoll	Voreinstellung
Transferclients (TFTP, SFTP, SCP)	Aktiviert
Transfer Server (SCP)	Deaktiviert

Tab. 2: File transfer protocols

Anmerkung: Die Verwendung der Optionen 66 - TFTP-Servername und Option 67 - Bootdateiname birgt Risiken. Das Gerät sendet nicht authentifizierte DHCP-Client-Nachrichten über den User Datagram Port (UDP) 67 an einen Server. Die Messages sind Broadcast-Nachrichten, d.h. jeder kann die Nachrichten empfangen und jeder kann auf die Nachrichten antworten.

Protokoll	Voreinstellung
Profinet	Deaktiviert

Tab. 3: Industrielle-Protokolle

2.2 Grafische Benutzeroberfläche starten

Voraussetzung:

- ▶ Die IP-Parameter des Gerätes sind festgelegt und das Gerät ist über das Netz erreichbar.
[Siehe „IP-Parameter festlegen“ auf Seite 15.](#)

Vorgehen:

- Starten Sie Ihren Web-Browser.
- Schreiben Sie die IP-Adresse des Gerätes in das Adressfeld des Web-Browsers. Verwenden Sie folgende Form: `https://xxx.xxx.xxx.xxx`

Der Web-Browser stellt die Verbindung zum Gerät her und zeigt das Log-in-Fenster.



- Wählen Sie die Sprache für die grafische Benutzeroberfläche.
- Wählen Sie den Benutzernamen und das Passwort:
- Klicken Sie „OK“.

Der Web-Browser zeigt das Fenster mit der grafischen Benutzeroberfläche.

3 Konfiguration laden/speichern

Das Gerät bietet Ihnen folgende Möglichkeiten, Konfigurationen zu laden oder zu speichern:

- ▶ [Konfiguration in den Lieferzustand zurücksetzen](#)
- ▶ [Konfiguration importieren](#)
- ▶ [Konfiguration im Gerät speichern](#)
- ▶ [Konfiguration exportieren](#)

Anmerkung: Geänderte Einstellungen speichert das Gerät im flüchtigen Arbeitsspeicher, wenn Sie auf „Schreiben“ klicken.

Über den Dialog `Grundeinstellungen > Laden/Speichern` speichern Sie geänderte Einstellungen nicht-flüchtig im lokalen Speicher des Gerätes.

3.1 Konfiguration in den Lieferzustand zurücksetzen

Bei einem Neustart lädt das Gerät seine Konfiguration vom lokalen nicht-flüchtigen Speicher.

Wenn Sie die Einstellungen im Gerät in den Lieferzustand zurücksetzen, löscht das Gerät die Konfiguration im flüchtigen Arbeitsspeicher und im nicht-flüchtigen Speicher. Anschließend startet das Gerät neu und lädt die voreingestellten Werte.

Voraussetzung:

- ▶ Sie greifen als Benutzer „admin“ mit Lese- und Schreibrechten auf das Gerät zu.

Vorgehen:

- Wählen Sie den Dialog *Grundeinstellungen* > *Laden/Speichern*.
- Klicken Sie im Rahmen „Laden/Speichern“ neben „Auf Lieferzustand zurücksetzen“ die Schaltfläche „Zurücksetzen“.

3.2 Konfiguration importieren

Das Gerät bietet Ihnen die Möglichkeit, Einstellungen aus einer Konfigurationsdatei von Ihrem PC oder von einem TFTP-Server zu laden.

Voraussetzung:

- ▶ Sie greifen als Benutzer „admin“ mit Lese- und Schreibrechten auf das Gerät zu.
- ▶ Import von einem TFTP-Server:
Die Konfigurationsdatei ist in den entsprechenden Pfad des TFTP-Servers mit dem Dateinamen gespeichert, z.B. `backup/config.bin`
[Siehe „Konfiguration exportieren“ auf Seite 34.](#)
- ▶ Import von Ihrem PC:
Die Konfigurationsdatei ist als Binärdatei auf Ihrem PC gespeichert.

Vorgehen:

- Wählen Sie den Dialog `Grundeinstellungen > Laden/Speichern`.
- Wählen Sie im Rahmen „Konfigurations-Übertragung“ für die Übertragungsrichtung den Wert `vom Server zum Gerät`.
 - ▶ Geben Sie den Pfad zur Konfigurationsdatei auf einem TFTP-Server ein.
Der URL kennzeichnet den Pfad zu der auf dem TFTP-Server gespeicherten Konfigurationsdatei mit dem Dateinamen. Der URL hat die Form
`tftp://IP-Adresse des tftp-Servers/Pfadname/Dateiname`.
 - ▶ Oder ziehen Sie die Datei per Drag-and-Drop in den gestrichelt umrandeten Bereich im Rahmen „Konfigurations-Übertragung“ .
Diese Möglichkeit unterstützen die gängigen Web-Browser mit Ausnahme des Internet Explorer.
- Klicken Sie „Übertragen“.
Nach erfolgreichem Übertragen aktivieren Sie die Konfiguration:
Starten Sie das Gerät neu, indem Sie „Neustart“ klicken.

Anmerkung: Das Laden einer Konfiguration bewirkt das Abschalten der Ports während des Einrichtens der Konfiguration. Danach setzt das Gerät den Portstatus entsprechend der neuen Konfiguration.

Anmerkung: Geänderte Einstellungen speichert das Gerät im flüchtigen Arbeitsspeicher, wenn Sie auf „Schreiben“ klicken.

Über den Dialog **Grundeinstellungen > Laden/Speichern** speichern Sie geänderte Einstellungen nicht-flüchtig im lokalen Speicher des Gerätes.

3.3 Konfiguration im Gerät speichern

Das Gerät bietet Ihnen die Möglichkeit, die aktuellen Konfigurationsdaten in den lokalen nicht-flüchtigen Speicher des Gerätes zu speichern.

Voraussetzung:

- ▶ Sie greifen als Benutzer „admin“ mit Lese- und Schreibrechten auf das Gerät zu.

Vorgehen:

- Wählen Sie den Dialog `Grundeinstellungen > Laden/Speichern`.
- Klicken Sie im Rahmen „Laden/Speichern“ neben „Aktuelle Konfiguration speichern“ die Schaltfläche „Speichern“.

3.4 Konfiguration exportieren

Das Gerät bietet Ihnen die Möglichkeit, Einstellungen in eine Konfigurationsdatei auf Ihrem PC oder auf einem TFTP-Server zu speichern.

Voraussetzung:

- ▶ Sie greifen als Benutzer „admin“ mit Lese- und Schreibrechten auf das Gerät zu.

Vorgehen:

- Wählen Sie den Dialog `Grundeinstellungen > Laden/Speichern`.
- Wählen Sie im Rahmen „Konfigurations-Übertragung“ für die Übertragungsrichtung den Wert `vom Gerät zum Server`.

- ▶ Entweder klicken Sie im Rahmen „Konfigurations-Übertragung“ neben „Speichern unter“ „Download“, um die Konfiguration auf Ihrem PC zu speichern.
- ▶ Oder geben Sie den Pfad zum Speicherort auf einem TFTP-Server ein.

Der URL kennzeichnet den Pfad zu der auf dem TFTP-Server gespeicherten Konfigurationsdatei mit dem Dateinamen. Der URL hat die Form

`ftp://IP-Adresse des tftp-Servers/Pfadname/Dateiname`.

Klicken Sie „Übertragen“.

Anmerkung: Geänderte Einstellungen speichert das Gerät im flüchtigen Arbeitsspeicher, wenn Sie auf „Schreiben“ klicken.

Über den Dialog `Grundeinstellungen > Laden/Speichern` speichern Sie geänderte Einstellungen nicht-flüchtig im lokalen Speicher des Gerätes.

4 Stand der Software prüfen/ Software aktualisieren

Hirschmann arbeitet ständig an der Leistungssteigerung der Produkte. Deshalb besteht die Möglichkeit, dass Sie auf der Internetseite von Hirschmann (www.hirschmann.com) eine neuere Release der Geräte-Software finden, als die Release, die auf Ihrem Gerät gespeichert ist.

4.1 Stand der Software prüfen

Das Gerät bietet Ihnen die Möglichkeit, den Stand der im Gerät gespeicherten Software anzuzeigen.

Vorgehen:

- Wählen Sie den Dialog `Grundeinstellungen > Software`.
- Der Rahmen „Laufende Version“ zeigt Ihnen die Release-Nummer der im Gerät gespeicherten Software an.

4.2 Software aktualisieren

Voraussetzung:

- ▶ Die Datei mit der aktuelleren Software-Version ist auf einem TFTP-Server, auf Ihrem PC oder auf einem Netzlaufwerk gespeichert.

Vorgehen:

- Wählen Sie den Dialog `Grundeinstellungen > Software`.

Sie haben 2 Möglichkeiten, die Software zu aktualisieren:

- ▶ Geben Sie den Pfad zur Geräte-Software auf einem TFTP-Server ein. Der URL kennzeichnet den Pfad zu der auf dem TFTP-Server gespeicherten Software mit dem Dateinamen. Der URL hat die Form `tftp://IP-Adresse des tftp-Servers/Pfadname/Dateiname`.
 - ▶ Oder ziehen Sie die Datei per Drag-and-Drop in den gestrichelt umrandeten Bereich im Rahmen „Software-Update“ . Diese Möglichkeit unterstützen die gängigen Web-Browser mit Ausnahme des Internet Explorer.
- Klicken Sie „Installieren“, um die Software auf das Gerät zu laden. Der Rahmen „Status“ zeigt den Fortschritt des Installationsvorganges. Nach erfolgreichem Installationsvorgang sehen Sie im Fortschrittsbalken die Meldung „Flash 100.00 % Abgeschlossen“.
 - Nach erfolgreichem Laden aktivieren Sie die neue Software: Starten Sie das Gerät neu, indem Sie „Neustart“ klicken.

5 Ports konfigurieren

Das Gerät bietet Ihnen folgende Möglichkeiten, grundlegende Einstellungen für die Ports festzulegen:

- ▶ **Port aus-/einschalten**
Um einen höheren Zugangsschutz zu erzielen, schalten Sie die Ports aus, an denen Sie keine weiteren Netzkomponenten anschließen.
- ▶ **Betriebsmodus wählen**
Das Gerät bietet Ihnen die Möglichkeit, die Datenrate und Halbduplex- oder Vollduplexverbindung manuell zu wählen oder automatisch durch das Gerät festlegen zu lassen (Autonegotiation).
- ▶ **Link-Überwachung (Alarmmeldungen) ein-/ausschalten**
Das Gerät bietet Ihnen die Möglichkeit, Alarmmeldungen an eine Netzmanagementstation zu übermitteln.

5.1 Port aus-/einschalten

Im Lieferzustand ist jeder Port eingeschaltet. Um einen höheren Zugangsschutz zu erzielen, schalten Sie die Ports aus, an denen Sie keine Netzkomponenten anschließen.

Vorgehen:

- Wählen sie den Dialog `Grundeinstellungen > Port > Konfiguration`
- Um einen Port ein- oder auszuschalten, wählen Sie in der Spalte „Zustand“ des jeweiligen Ports den Wert `Aus` oder `An`.

Anmerkung: Geänderte Einstellungen speichert das Gerät im flüchtigen Arbeitsspeicher, wenn Sie auf „Schreiben“ klicken.

Über den Dialog `Grundeinstellungen > Laden/Speichern` speichern Sie geänderte Einstellungen nicht-flüchtig im lokalen Speicher des Gerätes.

5.2 Betriebsmodus wählen

Im Lieferzustand befinden sich die Ports im Betriebsmodus „Autonegotiation“.

Bei Autonegotiation ermittelt das Gerät die maximal mögliche Datenrate und den Duplex-Betrieb zwischen den verbundenen Ports selbständig.

Ist bei der Gegenstelle Autonegotiation ausgeschaltet, verwendet das Gerät das Verfahren „Parallel Detection“. Das Gerät ermittelt die maximal mögliche Datenrate und wählt den Halb-Duplex Modus. Die Gegenstelle muss fest auf Halb-Duplex eingestellt sein, andernfalls ist das Ergebnis ein Duplex Mismatch (eine Seite unterstützt Voll-Duplex, die andere Seite unterstützt Halb-Duplex). Auswirkung ist eine sehr langsame Verbindung.

Vorgehen:

- Wählen Sie den Dialog `Grundeinstellungen > Port > Konfiguration`.
- Falls das an diesem Port angeschlossene Gerät eine feste Einstellung voraussetzt, wählen Sie in der Spalte „Manuelle Konfiguration“ die Übertragungsgeschwindigkeit und den Duplexbetrieb.

Anmerkung: Geänderte Einstellungen speichert das Gerät im flüchtigen Arbeitsspeicher, wenn Sie auf „Schreiben“ klicken.

Über den Dialog `Grundeinstellungen > Laden/Speichern` speichern Sie geänderte Einstellungen nicht-flüchtig im lokalen Speicher des Gerätes.

5.3 Link-Überwachung (Alarmmeldungen) ein-/ ausschalten

Das Gerät bietet Ihnen die Möglichkeit, Alarmmeldungen an eine Netzmanagementstation zu übermitteln. Im Dialog `Grundeinstellungen > Port > Konfiguration` legen Sie fest, ob das Gerät einen SNMP-Trap sendet, wenn es eine Änderung bei überwachten Funktionen erkennt. Die überwachten Funktionen legen Sie im Dialog `Diagnose > Alarme (Traps)` fest.

Vorgehen:

- Wählen Sie den Dialog `Grundeinstellungen > Port > Konfiguration`.
- Um die Übermittlung von Alarmmeldungen an eine Netzmanagementstation ein- oder auszuschalten, wählen Sie in der Spalte „Link-Überwachung“ des jeweiligen Ports in der Auswahlliste `An` oder `Aus`.
- Um die geänderten Einstellungen im flüchtigen Arbeitsspeicher des Gerätes zu speichern, klicken Sie „Schreiben“.

Anmerkung: Geänderte Einstellungen speichert das Gerät im flüchtigen Arbeitsspeicher, wenn Sie auf „Schreiben“ klicken.

Über den Dialog `Grundeinstellungen > Laden/Speichern` speichern Sie geänderte Einstellungen nicht-flüchtig im lokalen Speicher des Gerätes.

6 Unterstützung beim Schutz vor unberechtigten Zugriffen

Das Gerät bietet Ihnen folgende Möglichkeiten zur Unterstützung beim Schutz vor unberechtigten Zugriffen:

- ▶ **Passwörter ändern**
Um einen höheren Zugangsschutz zu erzielen, ändern Sie die voreingestellten Passwörter für den Zugriff auf das Gerät.
- ▶ **Port aus-/einschalten**
Schalten Sie die Ports aus, an denen Sie keine weiteren Netzkomponenten anschließen.
- ▶ **HiDiscovery-Zugriff aus-/einschalten**
Schränken Sie die HiDiscovery-Funktion des Gerätes ein oder schalten Sie sie aus, nachdem Sie dem Gerät die IP-Parameter zugewiesen haben.
- ▶ **SNMP-Zugriff anpassen**
Um unerwünschte Zugriffe auf das Gerät zu erschweren, ändern Sie die Community für Lese-/Schreibzugriffe, legen Sie für Lese-/Schreibzugriffe eine andere Community fest als für Lesezugriffe und verwenden Sie SNMPv1 oder SNMPv2 ausschließlich in abhörsicheren Umgebungen. Wir empfehlen, SNMPv3 zu nutzen und im Gerät den Zugriff über SNMPv1 und SNMPv2 auszuschalten.

6.1 Passwörter ändern

Anmerkung: Die Passwörter für den Zugriff auf das Gerät über die grafische Benutzeroberfläche entsprechen den Passwörtern für den Zugriff auf das Gerät über SNMPv3.

Eine Netzmanagementstation kommuniziert über das Simple Network Management Protocol (SNMP) mit dem Gerät.
Jedes SNMP-Paket enthält die IP-Adresse des sendenden Rechners und das Passwort, mit welchem der Absender des Paketes auf die Management Information Base (MIB) des Gerätes zugreifen will.

Das Gerät empfängt das SNMP-Paket und vergleicht die IP-Adresse des sendenden Rechners und das Passwort mit den Einträgen in der MIB des Gerätes.

Liegt das Passwort mit dem entsprechenden Zugriffsrecht vor und ist die IP-Adresse des sendenden Rechners eingetragen, dann gewährt das Gerät den Zugriff.

Voraussetzung:

- ▶ Sie greifen als Benutzer „admin“ mit Lese- und Schreibrechten auf das Gerät zu.

Bitte beachten Sie folgende Hinweise für ein Passwort:

- Definieren Sie ein neues Passwort, unter welchem Sie mit Schreibrechten von Ihrem Rechner aus zugreifen können.
Behandeln Sie dieses Passwort vertraulich, denn jeder, der das Passwort kennt, kann mit der IP-Adresse Ihres Rechners auf die MIB des Gerätes zugreifen.
- Stellen Sie für das Lese-/Schreib- und das Schreib-/Lese-/Schreib- unterschiedliche Passwörter ein, damit ein Benutzer, der ausschließlich Lesezugriff hat (Benutzername „user“), das Passwort für den Schreib-/Lesezugriff (Benutzername „admin“) nicht kennen oder erraten kann.

Vorgehen:

- Wählen Sie den Dialog `Gerätesicherheit > Passwort`.
- Wählen Sie „Lese Passwort ändern (user)“, um das Lese Passwort einzugeben oder „Schreib-/Lese Passwort ändern (admin)“, um das Schreib-/Lese Passwort einzugeben.
Die Mindestpasswortlänge beträgt 8 Zeichen. Zulässig sind alle Groß- und Kleinbuchstaben, Zahlen und Sonderzeichen.
- Geben Sie das Passwort des Benutzers „admin“ im Feld „Aktuelles Administrator-Passwort“ ein.
- Geben Sie das neue Passwort im Feld „Neues Passwort“ ein.
- Wiederholen Sie die Eingabe im Feld „Bitte nochmals eingeben“.
- Um die geänderten Einstellungen im flüchtigen Arbeitsspeicher des Gerätes zu speichern, klicken Sie „Schreiben“.

Anmerkung: Damit die Eingaben nach einem Neustart wieder zur Verfügung stehen, speichern Sie die Einstellungen über den Dialog „Laden/Speichern“ im lokalen nicht-flüchtigen Speicher des Gerätes .

6.2 HiDiscovery-Zugriff aus-/einschalten

Das HiDiscovery-Protokoll bietet Ihnen die Möglichkeit, dem Gerät über das Ethernet IP-Parameter zuzuweisen.

Weitere Informationen zu diesem Thema bietet Ihnen [„IP-Parameter über HiDiscovery festlegen“](#) auf Seite 17.

Anmerkung: Schränken Sie die HiDiscovery-Funktion des Gerätes ein oder schalten Sie sie aus, nachdem Sie dem Gerät die IP-Parameter zugewiesen haben.

Vorgehen:

- Wählen Sie den Dialog *Grundeinstellungen* > *Netz*.
- Um die HiDiscovery-Funktion auszuschalten, wählen Sie im Rahmen „HiDiscovery-Protokoll“ für „Funktion“ den Wert *Aus*.
- Um den Schreibzugriff auf das Gerät per HiDiscovery auszuschalten, wählen Sie im Rahmen „HiDiscovery-Protokoll“ für „Schreibrecht“ den Wert *Aus*.
- Um die geänderten Einstellungen im flüchtigen Arbeitsspeicher des Gerätes zu speichern, klicken Sie „Schreiben“.

Anmerkung: Geänderte Einstellungen speichert das Gerät im flüchtigen Arbeitsspeicher, wenn Sie auf „Schreiben“ klicken.

Über den Dialog *Grundeinstellungen* > *Laden/Speichern* speichern Sie geänderte Einstellungen nicht-flüchtig im lokalen Speicher des Gerätes.

6.3 SNMP-Zugriff anpassen

Das Protokoll SNMP bietet Ihnen die Möglichkeit, das Gerät über das Netz mit einem Netzmanagementsystem (NMS) zu überwachen und zu konfigurieren. Wenn das NMS über SNMPv1 oder SNMPv2 auf das Gerät zugreift, authentifiziert sich das NMS mit der Community. Wenn das NMS über SNMPv3 auf das Gerät zugreift, authentifiziert sich das NMS mit den Zugangsdaten eines Benutzers.

Treffen Sie folgende grundsätzlichen Vorkehrungen, um unerwünschte Zugriffe auf das Gerät zu erschweren:

- Ändern Sie die Community für Lese-/Schreibzugriffe. Behandeln Sie diese Community vertraulich. Jeder, der die Community kennt, hat die Möglichkeit, die Einstellungen des Gerätes zu ändern.
[Siehe „Community für Lese-/Schreibzugriffe ändern“ auf Seite 48.](#)
- Legen Sie für Lese-/Schreibzugriffe eine andere Community fest als für Lesezugriffe.
[Siehe „Community für Lese-/Schreibzugriffe ändern“ auf Seite 48.](#)
- Verwenden Sie SNMPv1 oder SNMPv2 ausschließlich in abhörsicheren Umgebungen. Die Protokolle verwenden keine Verschlüsselung. Die SNMP-Pakete enthalten die Community im Klartext. Wir empfehlen, SNMPv3 zu nutzen und im Gerät den Zugriff über SNMPv1 und SNMPv2 auszuschalten.
[Siehe „Zugriff über SNMPv1 oder SNMPv2 im Gerät ausschalten“ auf Seite 49.](#)
[Siehe „Zugriff über SNMPv3 im Gerät einschalten“ auf Seite 49.](#)

6.3.1 Community für Lese-/Schreibzugriffe ändern

Im Lieferzustand erreichen Sie das Gerät über die Communitys `public` (Lesezugriffe) und `private` (Lese-/Schreibzugriffe).

Die Community ist in jedem SNMP-Paket enthalten. Beim Empfangen vergleicht das Gerät diese Community mit den im Gerät festgelegten Communitys. Wenn die Communitys übereinstimmen, akzeptiert das Gerät das SNMP-Paket und gewährt den Zugriff.

Voraussetzung:

- ▶ Sie greifen als Benutzer „admin“ mit Lese- und Schreibrechten auf das Gerät zu.

Vorgehen:

- Öffnen Sie den Dialog `Gerätesicherheit > SNMP`.
Der Dialog zeigt die eingerichteten Communitys.
- Klicken Sie in der Zeile der Community `Schreiben` in das Feld „Name“. Geben Sie die Community ein.
 - ▶ Erlaubt sind bis zu 32 alphanumerische Zeichen.
 - ▶ Das Gerät unterscheidet zwischen Groß- und Kleinschreibung.
 - ▶ Legen Sie eine andere Community fest als für Lesezugriffe.
- Um die geänderten Einstellungen im flüchtigen Arbeitsspeicher des Gerätes zu speichern, klicken Sie „Schreiben“.

Anmerkung: Geänderte Einstellungen speichert das Gerät im flüchtigen Arbeitsspeicher, wenn Sie auf „Schreiben“ klicken.

Über den Dialog `Grundeinstellungen > Laden/Speichern` speichern Sie geänderte Einstellungen nicht-flüchtig im lokalen Speicher des Gerätes.

6.3.2 Zugriff über SNMPv1 oder SNMPv2 im Gerät ausschalten

Voraussetzung:

- ▶ Sie greifen als Benutzer „admin“ mit Lese- und Schreibrechten auf das Gerät zu.

Vorgehen:

- Öffnen Sie den Dialog *Gerätesicherheit* > *SNMP*.
- Um das Protokoll SNMPv1 zu deaktivieren, heben Sie die Markierung des Kontrollkästchens „SNMPv1 ein“ auf.
- Um das Protokoll SNMPv2 zu deaktivieren, heben Sie die Markierung des Kontrollkästchens „SNMPv2 ein“ auf.
- Um die geänderten Einstellungen im flüchtigen Arbeitsspeicher des Gerätes zu speichern, klicken Sie „Schreiben“.

Anmerkung: Geänderte Einstellungen speichert das Gerät im flüchtigen Arbeitsspeicher, wenn Sie auf „Schreiben“ klicken.

Über den Dialog *Grundeinstellungen* > *Laden/Speichern* speichern Sie geänderte Einstellungen nicht-flüchtig im lokalen Speicher des Gerätes.

6.3.3 Zugriff über SNMPv3 im Gerät einschalten

Voraussetzung:

- ▶ Sie greifen als Benutzer „admin“ mit Lese- und Schreibrechten auf das Gerät zu.

Vorgehen:

- Öffnen Sie den Dialog *Gerätesicherheit* > *SNMP*.
- Um das Protokoll SNMPv3 zu aktivieren, markieren Sie das Kontrollkästchen „SNMPv3 ein“.
- Um die geänderten Einstellungen im flüchtigen Arbeitsspeicher des Gerätes zu speichern, klicken Sie „Schreiben“.

Anmerkung: Geänderte Einstellungen speichert das Gerät im flüchtigen Arbeitsspeicher, wenn Sie auf „Schreiben“ klicken.

Über den Dialog **Grundeinstellungen** > **Laden/Speichern** speichern Sie geänderte Einstellungen nicht-flüchtig im lokalen Speicher des Gerätes.

7 Netzlaststeuerung

Das Gerät bietet Ihnen folgende Möglichkeiten, die Netzlast zu reduzieren:

- ▶ Gezielte Paketvermittlung
- ▶ Priorisieren des Datenverkehrs (Quality of Service)

7.1 Gezielte Paketvermittlung

Durch gezielte Paketvermittlung reduziert das Gerät die Netzlast.

Das Gerät lernt an jedem Port die MAC-Adresse der Absender von empfangenen Datenpaketen. Die Kombination „Port und MAC-Adresse“ speichert das Gerät in einer MAC-Adresstabelle (Forwarding Database).

Durch Anwenden des „Store-and-Forward“-Verfahrens speichert das Gerät empfangene Daten zwischen und prüft sie vor dem Weiterleiten auf Gültigkeit. Ungültige Datenpakete verwirft das Gerät.

7.1.1 Lernen der MAC-Adressen

Wenn das Gerät ein Datenpaket empfängt, prüft es, ob die MAC-Adresse des Absenders bereits in der MAC-Adresstabelle gespeichert ist. Ist die MAC-Adresse des Absenders noch unbekannt, erzeugt das Gerät einen neuen Eintrag. Anschließend vergleicht das Gerät die Ziel-MAC-Adresse des Datenpakets mit den in der MAC-Adresstabelle gespeicherten Einträgen:

- ▶ Datenpakete mit bekannter Ziel-MAC-Adresse vermittelt das Gerät gezielt an Ports, die bereits Datenpakete von dieser MAC-Adresse empfangen haben.
- ▶ Datenpakete mit unbekannter Zieladresse flutet das Gerät, d. h. das Gerät leitet diese Datenpakete an sämtliche Ports weiter.

7.1.2 Aging gelernter MAC-Adressen

Adressen, die das Gerät seit der Zeitspanne (Aging Time) von 30 Sekunden nicht ein weiteres Mal erkannt hat, löscht das Gerät aus der MAC-Adresstabelle. Ein Neustart oder das Zurücksetzen der MAC-Adresstabelle löscht die Einträge in der MAC-Adresstabelle.

7.1.3 Statische Adresseinträge erzeugen

Ergänzend zum Lernen der Absender-MAC-Adresse bietet Ihnen das Gerät die Möglichkeit, MAC-Adressen von Hand einzurichten. Diese MAC-Adressen bleiben eingerichtet und überdauern das Zurücksetzen der MAC-Adresstabelle sowie den Neustart des Gerätes.

Anhand von statischen Adresseinträgen bietet Ihnen das Gerät die Möglichkeit, Datenpakete gezielt an ausgewählte Geräte-Ports zu vermitteln.

Voraussetzung:

- ▶ Sie greifen als Benutzer „admin“ mit Lese- und Schreibrechten auf das Gerät zu.

Vorgehen:

- Öffnen Sie den Dialog `Switching > Filter` für MAC-Adressen.
- Um eine benutzerdefinierte MAC-Adresse hinzuzufügen, klicken Sie „Erzeugen“.
- Legen Sie im Feld „Adresse“ die Ziel-MAC-Adresse fest, für die der Tabelleneintrag gilt.
- Markieren Sie im Feld „Mögliche Ports“ die Geräte-Ports, an die das Gerät Datenpakete mit der angegebenen Ziel-MAC-Adresse vermittelt.
 - Markieren Sie genau einen Geräte-Port, wenn Sie im Feld „Adresse“ eine Unicast-MAC-Adresse festgelegt haben.
 - Markieren Sie einen oder mehrere Geräte-Ports, wenn Sie im Feld „Adresse“ eine Multicast-MAC-Adresse festgelegt haben.
- Klicken Sie „OK“.
- Um die geänderten Einstellungen im flüchtigen Arbeitsspeicher des Gerätes zu speichern, klicken Sie „Schreiben“.

Anmerkung: Geänderte Einstellungen speichert das Gerät im flüchtigen Arbeitsspeicher, wenn Sie auf „Schreiben“ klicken.
Über den Dialog *Grundeinstellungen* > *Laden/Speichern* speichern Sie geänderte Einstellungen nicht-flüchtig im lokalen Speicher des Gerätes.

7.1.4 Gelernte Adresseinträge löschen

Voraussetzung:

- ▶ Sie greifen als Benutzer „admin“ mit Lese- und Schreibrechten auf das Gerät zu.

Vorgehen:

- Um die gelernten Adressen aus der MAC-Adresstabelle (FDB) zu löschen, öffnen Sie den Dialog *Switching* > *Filter für MAC-Adressen* und klicken dort die Schaltfläche „Löschen“ neben dem zu löschenden Adresseintrag.
- Um die geänderten Einstellungen im flüchtigen Arbeitsspeicher des Gerätes zu speichern, klicken Sie „Schreiben“.

Anmerkung: Geänderte Einstellungen speichert das Gerät im flüchtigen Arbeitsspeicher, wenn Sie auf „Schreiben“ klicken.
Über den Dialog *Grundeinstellungen* > *Laden/Speichern* speichern Sie geänderte Einstellungen nicht-flüchtig im lokalen Speicher des Gerätes.

7.2 Priorisieren des Datenverkehrs (Quality of Service)

Anmerkung: Hintergrundinformation zu diesem Thema bietet Ihnen „[Grundlagen Spanning-Tree-Protokoll](#)“ auf Seite 149.

Quality of Service (QoS) ist ein in der Norm IEEE 802.1D beschriebenes Verfahren, mit dem Sie die Ressourcen im Netz verteilen. QoS gibt Ihnen die Möglichkeit, Daten wichtiger Anwendungen zu priorisieren.

Die Priorisierung verhindert insbesondere bei starker Netzlast, dass Datenverkehr mit geringerer Priorität verzögerungsempfindlichen Datenverkehr stört. Zum verzögerungsempfindlichen Datenverkehr zählen beispielsweise Sprach-, Video- und Echtzeitdaten.

7.2.1 Priorisierung einstellen

- Port-Priorität zuweisen
 - Öffnen Sie den Dialog Switching > QoS/Priorität > Port-Konfiguration.
 - In der Spalte „Port-Priorität“ definieren Sie die Priorität, mit welcher das Gerät die an diesem Port empfangenen Datenpakete ohne VLAN-Tag vermittelt.
 - In der Spalte „Trust Mode“ definieren Sie, nach welchem Kriterium das Gerät empfangenen Datenpaketen eine Verkehrsklasse zuordnet.
 - Um die geänderten Einstellungen im flüchtigen Arbeitsspeicher des Gerätes zu speichern, klicken Sie „Schreiben“.

- VLAN-Priorität einer Verkehrsklasse zuordnen
 - Öffnen Sie den Dialog `Switching > QoS/Priorität > 802.1D/p-Mapping`.
 - Um einer VLAN-Priorität eine Verkehrsklasse zuzuordnen, fügen Sie in der Spalte „Traffic-Class“ den betreffenden Wert ein.
 - Um die geänderten Einstellungen im flüchtigen Arbeitsspeicher des Gerätes zu speichern, klicken Sie „Schreiben“.

- DSCP einer Verkehrsklasse zuweisen
 - Öffnen Sie den Dialog `Switching > QoS/Priorität > IP-DSCP-Mapping`.
 - Tragen Sie in der Spalte „Traffic-Class“ die gewünschten Werte ein.
 - Um die geänderten Einstellungen im flüchtigen Arbeitsspeicher des Gerätes zu speichern, klicken Sie „Schreiben“.

Anmerkung: Geänderte Einstellungen speichert das Gerät im flüchtigen Arbeitsspeicher, wenn Sie auf „Schreiben“ klicken.

Über den Dialog `Grundeinstellungen > Laden/Speichern` speichern Sie geänderte Einstellungen nicht-flüchtig im lokalen Speicher des Gerätes.

8 Diagnose

Das Gerät bietet Ihnen folgende Diagnosewerkzeuge:

- ▶ [Alarme \(Traps\) einstellen](#)
- ▶ [Topologie-Erkennung anzeigen](#)
- ▶ [System-Log](#)

8.1 Alarme (Traps) einstellen

Das Gerät meldet außergewöhnliche Ereignisse, die während des Normalbetriebs auftreten, sofort an die Verwaltungsstation. Dies geschieht über Nachrichten, sogenannte „Traps“, die das Polling-Verfahren umgehen („Polling“: Abfrage der Datenstationen in regelmäßigen Abständen). Traps ermöglichen eine schnelle Reaktion auf außergewöhnliche Ereignisse.

Das Gerät sendet Traps an jene Hosts, die in der Zieltabelle für Traps eingetragen sind. Das Gerät bietet Ihnen die Möglichkeit, die Trap-Zieltabelle mit der Verwaltungsstation über SNMP zu konfigurieren.

■ Auflistung der SNMP-Traps

Die folgenden Tabelle zeigt eine kurze Liste der möglichen vom Gerät gesendeten Traps an:

Bezeichnung des Traps	Bedeutung
authenticationFailure	Wird gesendet, falls eine Station versucht, unberechtigt auf einen Agenten zuzugreifen.
coldStart	Wird während der Boot-Phase bei Kaltstarts gesendet (nach erfolgreicher Initialisierung des Netzmanagements).
linkDown	Wird gesendet, wenn die Verbindung zu einem Port unterbrochen wird.
linkUp	Wird gesendet, wenn die Verbindung zu einem Port hergestellt ist.
lldpRemTablesChange	wird gesendet, wenn sich ein Eintrag in der Topologie-Tabelle ändert
newRoot	Wird gesendet, wenn der sendende Agent zur neuen Wurzel des Spannbauums wird.
topologyChange	Wird gesendet, wenn sich der Port-Zustand von „blocking“ auf „forwarding“ oder von „forwarding“ auf „blocking“ ändert.

Tab. 4: Mögliche Traps

Voraussetzung:

- ▶ Sie greifen als Benutzer „admin“ mit Lese- und Schreibrechten auf das Gerät zu.

Vorgehen:

- Öffnen Sie den Dialog .

Dieser Dialog gibt Ihnen die Möglichkeit, zu bestimmen, welche Ereignisse einen Trap auslösen und wohin das Gerät diese Nachrichten sendet.

- Geben Sie im Rahmen „Zieladressen“ den Namen der Trap Community an, den das Gerät verwendet, um sich als Quelle des Traps zu identifizierenden.
- Geben Sie die IP-Adresse der Verwaltungsstationen an, an die das Gerät die Traps sendet.

Das Gerät generiert Traps für Änderungen, die im Rahmen ausgewählt wurden. Legen Sie mindestens einen SNMP-Manager an, der Traps empfängt.

8.2 Topologie-Erkennung anzeigen

Anmerkung: Hintergrundinformation zu diesem Thema bietet Ihnen [„Grundlagen Topologie-Erkennung“](#) auf Seite 169.

Vorgehen:

- Öffnen Sie den Dialog `Diagnose > LLDP`.

Der Rahmen „Topologie-Erkennung“ zeigt Ihnen die gesammelten LLDP-Informationen zu den Nachbargeräten an. Mit diesen Informationen ist eine Netzmanagementstation in der Lage, die Struktur Ihres Netzes darzustellen.

Parameter	Bedeutung
Port	Zeigt die Nummer des Geräte-Ports.
Nachbar-Bezeichner	Zeigt die Chassis-ID des Nachbargerätes. Dies kann z. B. die Basis-MAC-Adresse des Nachbargerätes sein.
Nachbar-IP-Adresse	Zeigt die IP-Adresse, mit der die Management-Funktionen des Nachbargerätes erreichbar sind.
Nachbar-Port-Beschreibung	Zeigt eine Beschreibung für den Geräte-Port des Nachbargerätes.
Nachbar-System-name	Zeigt den Gerätenamen des Nachbargerätes.
Nachbar-System-beschreibung	Zeigt eine Beschreibung für das Nachbargerät.

Wenn Sie an einen Port mehrere Geräte anschließen (z. B. über einen Hub), zeigt die Tabelle für jedes angeschlossene Gerät eine Zeile an.

Die Weiterleitungstabelle (FDB) enthält MAC-Adressen von Geräten, die die Topologie-Tabelle aus Gründen der Übersicht ausblendet.

8.3 System-Log

Die System-Log-Datei ist eine HTML-Datei, in die das Gerät alle wichtigen geräteinternen Ereignisse schreibt. Dieser Bericht gibt im Service-Fall dem Techniker die notwendigen Informationen.

In der Tabelle im Dialog `Diagnose > System Log` werden die protokollierten Ereignisse aufgeführt.

- Klicken Sie die Schaltfläche „Speichern“, um den Inhalt des Protokolls als HTML-Datei zu archivieren.

9 Unterstützung beim sicheren Fernzugriff

Das Gerät bietet Ihnen mit dem SiteManager GECKO ein Werkzeug zur Unterstützung beim sicheren Fernzugriff (Secure Remote Access).

Der sichere Fernzugriff bietet Ihnen folgende Möglichkeiten:

- ▶ Geografisch voneinander getrennt liegende Geräte verbinden.
- ▶ Fernprogrammierung von industriellen Komponenten mit den vertrauten Programmierwerkzeugen.
- ▶ Fernsteuerung und Fernüberwachung von industriellen Anlagen mit Hilfe Ihres PCs, iPhones oder Android-Geräts.
- ▶ Betrieb der Maschinen ohne physischen Zugang zu dem Maschinennetz
- ▶ Einsatz von Sicherheitsmechanismen auf normalerweise unsicheren Geräten (Tablets oder Smartphones).
- ▶ Erstellung von Accounts für Maschinenbediener mit getrennten Zugängen zu spezifischen Geräten.

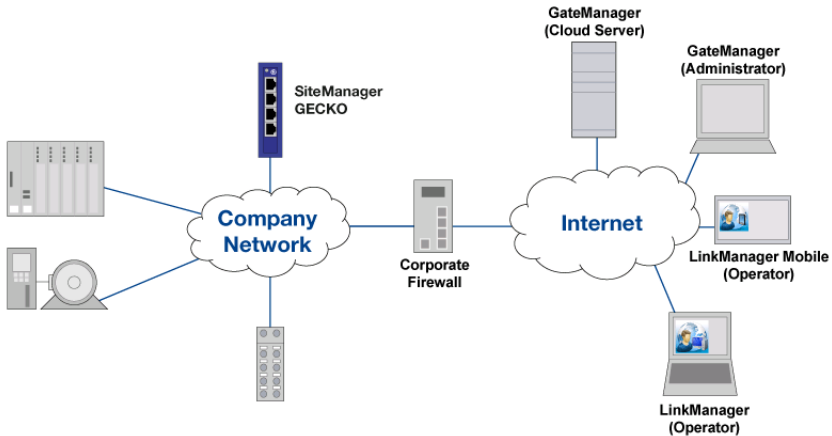

9.1 SiteManager GECKO

Der SiteManager GECKO ist ein Hirschmann-Client zur Unterstützung des sicheren Fernzugriffs. Er hilft beim Aufbau einer sicheren Verbindung von bis zu 10 an den SiteManager GECKO angebotenen Geräten.

Der Dialog bietet Ihnen folgende Möglichkeiten:

- ▶ Grundlegende Einstellungen für den SiteManager GECKO festlegen.
- ▶ Den Verbindungsstatus zum GateManager Server überwachen und die Softwareversion des Clients anzeigen.
- ▶ Den SiteManager GECKO Client auf den Lieferzustand zurücksetzen.
- ▶ Eine Log-Datei auf dem PC speichern.

9.1.1 SiteManager GECKO konfigurieren

Voraussetzung:

- ▶ Sie greifen als Benutzer „admin“ mit Lese- und Schreibrechten auf das Gerät zu.

Vorgehen:

- Öffnen Sie den Dialog `Secure Remote Access > SiteManager GECKO`.
- Markieren Sie im Rahmen „Konfiguration“ neben „Funktion“ das Kontrollkästchen „An“, um die Funktion einzuschalten.
- Legen Sie im Rahmen „Konfiguration“ folgende Werte fest:
 - Feld „GateManager Server“: IPv4-Adresse des GateManager Server.
 - Feld „GateManager Token“: Domänen-Token für die Verbindung zum GateManager GECKO.
 - Feld „Name“: Namen, der den SiteManager GECKO beschreibt.

Das Gerät startet den Verbindungsaufbau vom SiteManager GECKO zum GateManager. Der Rahmen „Status“ zeigt den Status der Verbindung.

■ Konfiguration

Bezeichnung	Bedeutung
Funktion	<p>Bei eingeschalteter Funktion baut das Gerät eine Verbindung zum GateManager auf.</p> <p>Mögliche Werte:</p> <ul style="list-style-type: none"> ▶ „An“ Der SiteManager GECKO baut mit den festgelegten Werten eine dauerhafte Verbindung zum GateManager auf. ▶ „Aus“ (Voreinstellung) Keine Verbindung zum GateManager.
GateManager Server	<p>Legt die IPv4-Adresse des GateManager Servers fest.</p> <p>Mögliche Werte:</p> <ul style="list-style-type: none"> ▶ Gültige IPv4-Adresse <p>Verwenden Sie einen Webproxy oder ein Gateway, falls die festgelegte Adresse im erreichbaren Subnetz (Netzmaske) unerreichbar ist. Das Gateway legen Sie fest im Dialog "Grundeinstellungen" > "Netz", Rahmen "IP-Parameter", Feld "Gateway-Adresse". Alternativ legen Sie das Gateway über HiDiscovery oder über einen DHCP-Server fest. Daten für den Webproxy legen Sie in den Feldern "Webproxy Address", "Webproxy Account" und "Webproxy Password" fest.</p>
GateManager Token	<p>Legt das Domänen-Token für die Verbindung zum GateManager GECKO fest.</p> <p>Mögliche Werte:</p> <ul style="list-style-type: none"> ▶ alphanumerische ASCII-Zeichenfolge
Name	<p>Legt die Bezeichnung für den Eintrag fest. Geben Sie einen Namen ein, der den SiteManager GECKO beschreibt.</p> <p>Mögliche Werte:</p> <ul style="list-style-type: none"> ▶ alphanumerische ASCII-Zeichenfolge
Webproxy Address	<p>Legt die IPv4-Adresse für den Webproxy fest.</p> <p>Mögliche Werte:</p> <ul style="list-style-type: none"> ▶ [leer] Kein Webproxy. ▶ Gültige IPv4-Adresse <p>Verwenden Sie ein Gateway, falls sich Webproxy und GECKO in unterschiedlichen Subnetzen befinden.</p>
Webproxy Account	<p>Legt den Benutzernamen fest, mit dem sich der Benutzer beim Webproxy authentifiziert.</p>
Webproxy Password	<p>Legt das Passwort fest, mit dem sich der Benutzer beim Webproxy authentifiziert.</p>

Tab. 5: Konfiguration

■ Status

Bezeichnung	Bedeutung
Status	<p>Zeigt den Status der Verbindung zwischen SiteManager GECKO und GateManager.</p> <p>Mögliche Werte:</p> <ul style="list-style-type: none">▶ Starte Das Gerät startet den Verbindungsaufbau. Der SiteManager GECKO überprüft die IP-Adresse des GateManagers.▶ Nicht verbunden Verbindung zwischen SiteManager GECKO und GateManager inaktiv.▶ Verbinde mit a.b.c.d Das Gerät baut die Verbindung zwischen SiteManager GECKO und GateManager auf. Falls Sie einen Webproxy verwenden, baut das Gerät die Verbindung zum GateManager über den Webproxy auf.▶ Verbunden mit a.b.c.d Verbindung zwischen SiteManager GECKO und GateManager aktiv.

Tab. 6: *Status*

■ SiteManager GECKO

Bezeichnung	Bedeutung
Laufende Version	<p>Zeigt die Versionsnummer des SiteManager GECKO, die das Gerät derzeit ausführt.</p> <p>Der GateManager bietet Ihnen die Möglichkeit, ausschließlich den SiteManager GECKO zu aktualisieren.</p> <p>Der Rahmen "Software-Update" im Dialog "Grundeinstellungen" > "Software" bietet Ihnen die Möglichkeit, die Geräte-Software des GECKO und den SiteManager GECKO gleichzeitig zu aktualisieren.</p> <p>Siehe „Software aktualisieren“ auf Seite 37</p>

Tab. 7: *SiteManager GECKO*

■ Schaltflächen

Reset	SiteManager GECKO auf Auslieferungszustand zurücksetzen Setzt den SiteManager GECKO auf den Lieferzustand zurück. Das Gerät überschreibt die über den GateManager installierten Updates. Die GECKO-Geräte-Software bleibt erhalten. Die GECKO-Geräte-Software setzen Sie zurück über die Schaltfläche "Auf Lieferzustand zurücksetzen" im Dialog "Grundeinstellungen > Laden/Speichern".
Speichern	SiteManager GECKO Log Speichert die Log-Datei "sitemanager_syslog0.txt" auf ihrem PC. Die Datei enthält detaillierte Verbindungs- und Laufzeitinformationen
Laden	Lädt die Anzeige der Seite in Ihrem Web-Browser neu.
Schreiben	Überträgt die Änderungen in den flüchtigen Speicher des Gerätes. Um die Änderungen im nicht-flüchtigen lokalen Speicher des Gerätes zu speichern, gehen Sie wie folgt vor: <input type="checkbox"/> Öffnen Sie den Dialog Grundeinstellungen > Laden/Speichern . <input type="checkbox"/> Klicken Sie „Speichern“ im Rahmen „Laden/Speichern“ neben „Aktuelle Konfiguration speichern“.
Hilfe	Öffnet die Online-Hilfe.

10 Redundanzverfahren Rapid Spanning Tree Protocol konfigurieren

Anmerkung: Hintergrundinformation zu diesem Thema bietet Ihnen [„Grundlagen Spanning-Tree-Protokoll“](#) auf Seite 149.

Das Gerät unterstützt das in der Norm IEEE 802.1D-2004 definierte Rapid Spanning Tree Protocol (RSTP). Dieses Protokoll ist eine Weiterentwicklung des Spanning Tree Protocols (STP) und zu diesem kompatibel.

Das Rapid Spanning Tree Protocol ermöglicht schnelles Umschalten auf eine Neuberechnete Topologie, ohne dabei bestehende Verbindungen zu unterbrechen.

RSTP konfiguriert die Netztopologie komplett selbständig. Das Gerät mit der niedrigsten Bridge-Priorität wird dabei automatisch Root-Bridge.

Um dennoch eine bestimmte Netzstruktur vorzugeben, legen Sie ein Gerät als Root-Bridge fest. Im Regelfall übernimmt diese Rolle ein Gerät im Backbone.

Vorgehen:

- Bauen Sie das Netz nach Ihren Erfordernissen auf, zunächst ohne redundante Strecken.
- Schalten Sie Spanning Tree auf allen Geräten im Netz ein.
Im Lieferzustand ist Spanning Tree auf dem Gerät eingeschaltet.
 - Öffnen Sie den Dialog Redundanz > Spanning Tree > Global.
 - Wählen Sie im Rahmen „Funktion“ den Wert An.
- Klicken Sie „Schreiben“, um die Änderungen zu speichern.
- Schließen Sie nun die redundanten Strecken an.
- Legen Sie die Einstellungen für das Gerät fest, das die Rolle der Root-Bridge übernimmt.
- Legen Sie im Feld „Priorität“ einen numerisch kleineren Wert fest.
Die Bridge mit der numerisch niedrigsten Bridge-ID hat die höchste Priorität und wird zur Root-Bridge des Netzes.
- Klicken Sie „Schreiben“, um die Änderungen zu speichern.
- Ändern Sie gegebenenfalls die Werte in den Feldern „Forward Delay [s]“ und „Max Age“.
- Klicken Sie „Schreiben“, um die Änderungen zu speichern.

Anmerkung: Die Parameter „Forward Delay [s]“ und „Max Age“ stehen in folgender Beziehung zueinander:

„Forward Delay [s]“ \geq („Max Age“/2) + 1

Wenn Sie in die Felder einen Wert einfügen, der dieser Beziehung widerspricht, ersetzt das Gerät diese Werte mit den zuletzt gültigen Werten oder mit der Voreinstellung.

- Prüfen Sie in den anderen Geräten die folgende Werte:
 - Bridge-ID (Bridge-Priorität und MAC-Adresse) des jeweiligen Gerätes sowie der Root-Bridge.
 - Nummer des Geräte-Ports, der zur Root-Bridge führt.
 - Pfadkosten vom Root-Port des Gerätes bis zur Root-Bridge.

11 Referenzen

Dieses Kapitel bietet Ihnen Beschreibungen der einzelnen Parameter, die Sie über die grafische Benutzeroberfläche konfigurieren.

Anmerkung: Die Inhalte der Online-Hilfe entsprechen den Informationen im Kapitel „Referenzen“ im Anwender-Handbuch Konfiguration. Rufen Sie die Online-Hilfe über die Schaltfläche „Hilfe“ in der grafischen Benutzeroberfläche auf.

11.1 Grundeinstellungen

Dieses Menü bietet Ihnen die Möglichkeit, die grundlegenden Einstellungen des Gerätes zu konfigurieren.



11.1.1 Grundeinstellungen > System

Dieser Dialog zeigt Geräteeigenschaften an.

■ Systemdaten

Parameter	Bedeutung
Name	Legt den Gerätenamen fest. Mögliche Werte: ▶ Alphanumerische ASCII-Zeichenfolge mit 0..255 Zeichen
Standort	Legt den Standort des Geräts fest. Mögliche Werte: ▶ Alphanumerische ASCII-Zeichenfolge mit 0..255 Zeichen
Ansprechpartner	Legt den Ansprechpartner für dieses Gerät fest. Mögliche Werte: ▶ Alphanumerische ASCII-Zeichenfolge mit 0..255 Zeichen
Gerätetyp	Zeigt die Produktbezeichnung des Geräts.
Betriebszeit	Zeigt die Zeit, die seit dem letzten Neustart dieses Geräts vergangen ist. Mögliche Werte: ▶ Zeit im Format <code>day(s), hh:mm:ss</code>

■ Schaltflächen

	Beendet die Sitzung und trennt die Verbindung zum Gerät.
	Startet das Gerät neu.
<input type="text" value="476"/>	Zeigt die Zeit in Sekunden, nach der das Gerät bei Inaktivität des Benutzers die Sitzung automatisch beendet.
Laden	Lädt die Anzeige der Seite in Ihrem Web-Browser neu.
Schreiben	Überträgt die Änderungen in den flüchtigen Speicher des Gerätes. Um die Änderungen im nicht-flüchtigen lokalen Speicher des Gerätes zu speichern, gehen Sie wie folgt vor: <ul style="list-style-type: none"> <input type="checkbox"/> Öffnen Sie den Dialog Grundeinstellungen > Laden/Speichern. <input type="checkbox"/> Klicken Sie „Speichern“ im Rahmen „Laden/Speichern“ neben „Aktuelle Konfiguration speichern“.
Hilfe	Öffnet die Online-Hilfe.

11.1.2 Grundeinstellungen > Netz

Dieser Dialog bietet Ihnen die Möglichkeit, die für den Zugriff über das Netz auf das Management des Gerätes erforderlichen IP- und HiDiscovery-Einstellungen festzulegen.

■ Management-Schnittstellen

Parameter	Bedeutung
Zuweisung IP-Adresse	<p>Legt fest, aus welcher Quelle das Gerät nach dem Starten seine IP-Parameter erhält:</p> <p>Mögliche Werte:</p> <ul style="list-style-type: none"> ▶ BOOTP Das Gerät erhält seine IP-Parameter von einem BOOTP- oder DHCP-Server. Der Server wertet die MAC-Adresse des Geräts aus und weist daraufhin die IP-Parameter zu. ▶ DHCP (Lieferzustand) Das Gerät erhält seine IP-Parameter von einem DHCP-Server. Der Server wertet die MAC-Adresse, den DHCP-Namen oder andere Parameter des Geräts aus und weist daraufhin die IP-Parameter zu. ▶ Local Das Gerät verwendet die IP-Parameter aus dem internen Speicher. Die Einstellungen dafür legen Sie im Rahmen „IP-Parameter“ fest. <p>Anmerkung: Bleibt die Antwort des BOOTP- oder DHCP-Servers aus, setzt das Gerät die IP-Adresse auf 0.0.0.0 und versucht erneut, eine gültige IP-Adresse zu erhalten.</p>
VLAN ID 1	<p>Legt die ID des VLANs fest, in dem das Management des Gerätes über das Netz erreichbar ist. Das Management ist ausschließlich über Ports erreichbar, die Mitglied dieses VLANs sind.</p> <p>Mögliche Werte:</p> <ul style="list-style-type: none"> ▶ 1..4042 (Voreinstellung: 1) Voraussetzung ist, dass das VLAN bereits eingerichtet ist. Siehe Dialog Switching > VLAN > Konfiguration. Legen Sie eine VLAN-ID fest, die keinem Router-Interface zugewiesen ist. Wenn Sie nach Ändern des Werts die Schaltfläche „Schreiben“ klicken, öffnet sich der Dialog Information. Wählen Sie den Port aus, über den Sie die Verbindung zum Gerät zukünftig herstellen. Nach Klicken der Schaltfläche „OK“ sind die Einstellungen des neuen Management-VLANs dem Port zugewiesen. <ul style="list-style-type: none"> – Der Port wird Mitglied des VLANs und vermittelt die Datenpakete ohne VLAN-Tag (untagged). Siehe Dialog Switching > VLAN > Konfiguration. – Das Gerät weist dem Port die Port-VLAN-ID des neuen Management-VLANs zu. Siehe Dialog Switching > VLAN > Port. Nach kurzer Wartezeit ist das Gerät über den neuen Port im neuen Management-VLAN erreichbar.
MAC-Adresse	<p>Zeigt die MAC-Adresse des Geräts. Mit der MAC-Adresse ist das Management des Gerätes über das Netz erreichbar.</p>

■ IP-Parameter

Parameter	Bedeutung
IP-Adresse	<p>Legt die IP-Adresse fest, unter der das Management des Geräts über das Netz erreichbar ist.</p> <p>Mögliche Werte:</p> <ul style="list-style-type: none"> ▶ Gültige IPv4-Adresse (Voreinstellung: —)
Netmaske	<p>Legt die Netzmaste fest. Die Netzmaste kennzeichnet in der IP-Adresse das Netzpräfix und die Host-Adresse des Geräts.</p> <p>Mögliche Werte:</p> <ul style="list-style-type: none"> ▶ Gültige IPv4-Netzmaste (Voreinstellung: —)
Gateway-Adresse	<p>Legt die IP-Adresse eines Routers fest, über den das Gerät andere Geräte außerhalb des eigenen Netzes erreicht.</p> <p>Mögliche Werte:</p> <ul style="list-style-type: none"> ▶ Gültige IPv4-Adresse (Voreinstellung: —)



■ HiDiscovery-Protokoll

Auf einem PC zeigt Ihnen die HiDiscovery-Software im Netz erreichbare Hirschmann-Geräte, auf denen die HiDiscovery-Funktion eingeschaltet ist. Sie erreichen die Geräte sogar dann, wenn diese keine oder ungültige IP-Parameter haben. Die HiDiscovery-Software bietet Ihnen die Möglichkeit, die IP-Parameter im Gerät zu ändern.

Parameter	Bedeutung
Funktion	<p>Schaltet die HiDiscovery-Funktion im Gerät ein/aus.</p> <p>Mögliche Werte:</p> <ul style="list-style-type: none"> ▶ An (Voreinstellung) HiDiscovery ist eingeschaltet. Sie haben die Möglichkeit, das Gerät mit der HiDiscovery-Software von Ihrem PC aus zu erreichen. ▶ Aus HiDiscovery ist ausgeschaltet.

Parameter	Bedeutung
Schreibrecht	<p>Schaltet den Schreibzugriff auf das Gerät per HiDiscovery an/aus.</p> <p>Mögliche Werte:</p> <ul style="list-style-type: none"> ▶ An (Voreinstellung) Die HiDiscovery-Software erhält Schreibzugriff auf das Gerät. Mit dieser Einstellung haben Sie die Möglichkeit, die IP-Parameter im Gerät zu ändern. ▶ Aus Die HiDiscovery-Software erhält ausschließlich Lesezugriff auf das Gerät. Mit dieser Einstellung haben Sie die Möglichkeit, die IP-Parameter im Gerät anzusehen. <p>Empfehlung: Ändern Sie erst nach Inbetriebnahme des Gerätes die Einstellung auf Aus.</p>

■ Schaltflächen

	Beendet die Sitzung und trennt die Verbindung zum Gerät.
	Alphanumerische ASCII-Zeichenfolge mit 0..64 Zeichen
	Zeigt die Zeit in Sekunden, nach der das Gerät bei Inaktivität des Benutzers die Sitzung automatisch beendet.
Laden	Lädt die Anzeige der Seite in Ihrem Web-Browser neu.
Schreiben	<p>Überträgt die Änderungen in den flüchtigen Speicher des Gerätes. Um die Änderungen im nicht-flüchtigen lokalen Speicher des Gerätes zu speichern, gehen Sie wie folgt vor:</p> <ul style="list-style-type: none"> <input type="checkbox"/> Öffnen Sie den Dialog <i>Grundeinstellungen > Laden/Speichern</i>. <input type="checkbox"/> Klicken Sie „Speichern“ im Rahmen „Laden/Speichern“ neben „Aktuelle Konfiguration speichern“.
Hilfe	Öffnet die Online-Hilfe.

11.1.3 Grundeinstellungen > Software

Dieser Dialog bietet Ihnen die Möglichkeit, die Geräte-Software zu aktualisieren und Informationen über die Geräte-Software anzuzeigen.

■ Version

Parameter	Bedeutung
Bootcode	Zeigt Versionsnummer und Erstellungsdatum des Bootcodes.
Laufende Version	Zeigt Versionsnummer und Erstellungsdatum der Geräte-Software, die das Gerät beim letzten Neustart geladen hat und gegenwärtig ausführt.

■ Software-Update



Parameter	Bedeutung
Datei	<p>Legt Pfad und Dateiname der Datei fest, mit der Sie die Geräte-Software aktualisieren.</p> <p>Das Gerät bietet Ihnen die Möglichkeit, die Geräte-Software per TFTP-Download zu aktualisieren.</p> <p><input type="checkbox"/> Geben Sie den URL zur Datei in der folgenden Form ein: <code>tftp://<IP address>/<path>/<file name></code></p>
Upload	<p>Das Gerät bietet Ihnen die Möglichkeit, die Datei, mit der Sie die die Geräte-Software aktualisieren, per Drag-and-Drop abzulegen. Diese Möglichkeit unterstützen die gängigen Web-Browser mit Ausnahme des Internet Explorer.</p> <p><input type="checkbox"/> Ziehen Sie die Datei per Drag-and-Drop in den gestrichelt umrandeten Bereich.</p>
Installieren	<p>Aktualisiert die Geräte-Software.</p> <p>Das Gerät installiert die im Feld „Datei“ festgelegte oder per Drag-and-Drop abgelegte Datei im lokalen nicht-flüchtigen Speicher und ersetzt die bisher dort gespeicherte Geräte-Software. Beim nächsten Neustart lädt das Gerät die installierte Geräte-Software.</p>

■ Status

Parameter	Bedeutung
URL	Zeigt die URL zur Datei, mit der Sie die Geräte-Software aktualisieren.

Parameter	Bedeutung
Fortschritt	Zeigt den Fortschritt der Aktualisierung der Geräte-Software.

■ Schaltflächen

	Beendet die Sitzung und trennt die Verbindung zum Gerät.
	Alphanumerische ASCII-Zeichenfolge mit 0..64 Zeichen
	Zeigt die Zeit in Sekunden, nach der das Gerät bei Inaktivität des Benutzers die Sitzung automatisch beendet.
Laden	Lädt die Anzeige der Seite in Ihrem Web-Browser neu.
Neustart	Startet das Gerät neu.
Hilfe	Öffnet die Online-Hilfe.

11.1.4 Grundeinstellungen > Laden/Speichern

Dieser Dialog bietet Ihnen die Möglichkeit, das Konfigurationsprofil permanent zu speichern. Wenn Sie im laufenden Betrieb in einem Dialog die Schaltfläche „Schreiben“ klicken, speichert das Gerät die Änderungen lediglich flüchtig.

Sie haben die Möglichkeit, Konfigurationsprofile auf zu exportieren oder in das Gerät zu kopieren.

■ Laden/Speichern



Parameter	Bedeutung
Speichern	Überträgt die Einstellungen aus dem flüchtigen Speicher (RAM) in das als ausgewählt gekennzeichnete Konfigurations-Profil im permanenten Speicher (NVM).

Parameter	Bedeutung
Zurücksetzen	Setzt die Einstellungen im Gerät auf die voreingestellten Werte zurück. <ul style="list-style-type: none"> ▶ Das Gerät löscht die gespeicherten Konfigurationsprofile aus dem flüchtigen Speicher (RAM) und aus dem permanenten Speicher (NVM).

■ Konfigurations-Übertragung

Parameter	Bedeutung
Übertragungsrichtung	Legt die Übertragungsrichtung fest, in der das Konfigurationsprofil übertragen wird. Mögliche Werte: <ul style="list-style-type: none"> ▶ Device to server Wählen Sie diesen Wert aus, wenn Sie das Konfigurationsprofil vom Gerät übertragen. ▶ Server to device Wählen Sie diesen Wert aus, wenn Sie das Konfigurationsprofil zum Gerät übertragen.
Server-IP-Adresse	Legt die IP-Adresse des Servers fest, von oder zu dem das Konfigurationsprofil übertragen wird. Geben Sie den URL zur Datei in der folgenden Form ein: tftp://<IP address>/<path>/<file name>
Übertragen	Überträgt das Konfigurationsprofil in der gewählten Übertragungsrichtung.
Download	Exportiert das aktuelle Konfigurationsprofil als Datei im Binärformat.

■ Schaltflächen

	Beendet die Sitzung und trennt die Verbindung zum Gerät.
	Alphanumerische ASCII-Zeichenfolge mit 0..64 Zeichen
	Zeigt die Zeit in Sekunden, nach der das Gerät bei Inaktivität des Benutzers die Sitzung automatisch beendet.
Laden	Lädt die Anzeige der Seite in Ihrem Web-Browser neu.
Hilfe	Öffnet die Online-Hilfe.

11.1.5 Grundeinstellungen > Port > Konfiguration



Dieser Dialog bietet Ihnen die Möglichkeit, Einstellungen für die einzelnen Geräte-Ports festzulegen. Der Dialog zeigt außerdem Betriebsmodus und Verbindungszustand für jeden Geräte-Port.

■ Konfiguration

Parameter	Bedeutung
Port	Zeigt die Nummer des Geräte-Ports.
Status	Aktiviert/deaktiviert den Geräte-Port. Mögliche Werte: <ul style="list-style-type: none"> ▶ On (Voreinstellung) Der Geräte-Port ist aktiviert. ▶ Off Der Geräte-Port ist deaktiviert. Der Geräte-Port sendet und empfängt keine Daten.
Link/Aktueller Betriebsmodus	Zeigt den Betriebsmodus, den der Geräte-Port momentan verwendet. Mögliche Werte: <ul style="list-style-type: none"> ▶ - Kein Kabel angesteckt, keine Verbindung. ▶ 10 Mbit/s HDX Halbduplex-Verbindung ▶ 10 Mbit/s FDX Vollduplex-Verbindung ▶ 100 Mbit/s HDX Halbduplex-Verbindung ▶ 100 Mbit/s FDX Vollduplex-Verbindung

Parameter	Bedeutung
Manuelle Konfiguration	<p>Legt den Betriebsmodus des Geräte-Ports fest.</p> <p>Mögliche Werte:</p> <ul style="list-style-type: none"> ▶ Autoneg (Voreinstellung) Der Geräte-Port handelt den Betriebsmodus per Autonegotiation selbständig aus und erkennt die Belegung der Anschlüsse des TP-Ports automatisch (Auto Cable-Crossing). Diese Einstellung hat Vorrang vor der manuellen Einstellung des Betriebsmodus. Bis der Geräte-Port den Betriebsmodus eingestellt hat, vergehen einige Sekunden. ▶ 10 Mbit/s HDX Halbduplex-Verbindung ▶ 10 Mbit/s FDX Voll duplex-Verbindung ▶ 100 Mbit/s HDX Halbduplex-Verbindung ▶ 100 Mbit/s FDX (Voreinstellung auf TP-Ports) Voll duplex-Verbindung
Link-Überwachung	<p>Aktiviert/deaktiviert die Meldung von erkannten Verbindungsfehlern.</p> <p>Mögliche Werte:</p> <ul style="list-style-type: none"> ▶ On Die Link-Überwachung ist eingeschaltet. ▶ Off Die Link-Überwachung ist ausgeschaltet.

■ Schaltflächen

	Beendet die Sitzung und trennt die Verbindung zum Gerät.
	Alphanumerische ASCII-Zeichenfolge mit 0..64 Zeichen
	Zeigt die Zeit in Sekunden, nach der das Gerät bei Inaktivität des Benutzers die Sitzung automatisch beendet.
Laden	Lädt die Anzeige der Seite in Ihrem Web-Browser neu.
Schreiben	<p>Überträgt die Änderungen in den flüchtigen Speicher des Gerätes. Um die Änderungen im nicht-flüchtigen lokalen Speicher des Gerätes zu speichern, gehen Sie wie folgt vor:</p> <ul style="list-style-type: none"> <input type="checkbox"/> Öffnen Sie den Dialog Grundeinstellungen > Laden/Speichern. <input type="checkbox"/> Klicken Sie „Speichern“ im Rahmen „Laden/Speichern“ neben „Aktuelle Konfiguration speichern“.
Hilfe	Öffnet die Online-Hilfe.



11.1.6 Grundeinstellungen > Port > Statistiken

Dieser Rahmen zeigt pro Geräte-Port folgenden Überblick:

- ▶ Anzahl der vom Gerät gesendeten Datenpakete/Bytes
 - ▶ „Gesendete Pakete“
 - ▶ „Gesendete Unicast-Pakete“
 - ▶ „Gesendete Non-Unicast-Pakete“
- ▶ Anzahl der vom Gerät empfangenen Datenpakete/Bytes
 - ▶ „Empfangene Pakete“
 - ▶ „Empfangene Bytes“
- ▶ Anzahl der vom Gerät erkannten Fehler
 - ▶ „Erkannte Kollisionen“
 - ▶ „Erkannte CRC-Fehler“
 - ▶ „Empfangene Fragmente“
- ▶ Anzahl der vom Gerät empfangenen und gesendeten Datenpakete pro Größenkategorie
 - ▶ „Pakete 64 Byte“
 - ▶ „Pakete 65 to 127 Byte“
 - ▶ „Pakete 128 to 255 Byte“
 - ▶ „Pakete 256 to 511 Byte“
 - ▶ „Pakete 512 to 1023 Byte“
 - ▶ „Pakete 1024 to 1518 Byte“

Um die Portstatistik-Zähler in der Tabelle auf 0 zurückzusetzen, klicken Sie „Portzähler zurücksetzen“ im Dialog Grundeinstellungen > Port > Statistiken.

■ Schaltflächen

	Beendet die Sitzung und trennt die Verbindung zum Gerät.
	Alphanumerische ASCII-Zeichenfolge mit 0..64 Zeichen
	Zeigt die Zeit in Sekunden, nach der das Gerät bei Inaktivität des Benutzers die Sitzung automatisch beendet.

Portzähler zurücksetzen	Setzt die Portstatistik-Zähler in der Tabelle auf 0 zurück.
Hilfe	Öffnet die Online-Hilfe.

11.2 Gerätesicherheit

Dieses Menü bietet Ihnen die Möglichkeit, die Einstellungen für den Zugriff auf das Gerät festzulegen.

11.2.1 Gerätesicherheit > Passwort

Das Gerät gewährt Benutzern Zugriff auf seine Management-Funktionen, wenn diese sich mit gültigen Zugangsdaten anmelden.



■ Passwort auswählen (HTTPS/SNMPv3)

Parameter	Bedeutung
Passwort auswählen	<p>Zeigt das zu ändernde Passwort.</p> <p>Mögliche Werte:</p> <ul style="list-style-type: none"> ▶ Modify read-only Password (user) Ändert das Passwort für den Lesezugriff. ▶ Modify read\write Password (admin) Ändert das Passwort für den Schreib- und Lesezugriff.
Aktuelles Administrator-Passwort	Geben Sie hier das Administrator-Passwort ein.
Neues Passwort	<p>Geben Sie hier das neue Passwort ein. Die Mindestpasswortlänge beträgt 8 Zeichen.</p> <p>Mögliche Werte:</p> <ul style="list-style-type: none"> ▶ a-z, A-Z ▶ #\$\$%&#()*+,-./:;<=>?@[]^'{}~!
Bitte nochmals eingeben.	Geben Sie hier das neue Passwort nochmals ein.

■ Aktivierer Benutzeraccount (nur lesend)

Parameter	Bedeutung
Aktuelles Administrator-Passwort	Geben Sie hier das Administrator-Passwort ein.
Benutzer aktivieren (user)	Aktiviert das Benutzerkonto. Wenn Sie das Benutzerkonto aktivieren, kann ein Benutzer mit den Zugangsdaten <code>user/public</code> auf das Gerät zugreifen.

■ Schaltflächen

	Beendet die Sitzung und trennt die Verbindung zum Gerät.
	Alphanumerische ASCII-Zeichenfolge mit 0..64 Zeichen
	Zeigt die Zeit in Sekunden, nach der das Gerät bei Inaktivität des Benutzers die Sitzung automatisch beendet.
Laden	Lädt die Anzeige der Seite in Ihrem Web-Browser neu.
Schreiben	Überträgt die Änderungen in den flüchtigen Speicher des Gerätes. Um die Änderungen im nicht-flüchtigen lokalen Speicher des Gerätes zu speichern, gehen Sie wie folgt vor: <ul style="list-style-type: none"> <input type="checkbox"/> Öffnen Sie den Dialog <code>Grundeinstellungen > Laden/Speichern</code>. <input type="checkbox"/> Klicken Sie „Speichern“ im Rahmen „Laden/Speichern“ neben „Aktuelle Konfiguration speichern“.
Hilfe	Öffnet die Online-Hilfe.

11.2.2 Gerätesicherheit > HTTPS

Dieser Dialog bietet Ihnen die Möglichkeit, Einstellungen für den HTTPS-Server des Gerätes festzulegen und den Server neu zu starten.

Der HTTPS-Server liefert die grafische Benutzeroberfläche (GUI) über eine verschlüsselte HTTP-Verbindung aus. Die grafische Benutzeroberfläche kommuniziert SNMP-basiert mit dem Gerät über die verschlüsselte HTTP-Verbindung und ermöglicht den Zugriff auf die Management-Funktionen.

Für die Verschlüsselung der HTTP-Verbindung ist ein digitales Zertifikat notwendig. Das Gerät bietet Ihnen die Möglichkeit, dieses Zertifikat selbst zu erzeugen oder ein vorhandenes Zertifikat auf das Gerät zu laden.

■ Konfiguration

Parameter	Bedeutung
Web-Interface Session-Timeout [s]	Legt die Timeout-Zeit in Sekunden fest. Bei Inaktivität beendet das Gerät nach dieser Zeit die Sitzung des angemeldeten Benutzers.
TCP-Port	<p>Legt die Nummer des TCP-Ports fest, auf dem der Server Anfragen von den Clients entgegen nimmt.</p> <p>Mögliche Werte:</p> <ul style="list-style-type: none"> ▶ 1..65535 (Voreinstellung: 443) <p>Nach Ändern des Ports startet der Server automatisch neu. Offene Verbindungen zum Server beendet das Gerät dabei.</p>



■ Zertifikat

Parameter	Bedeutung
Status	<p>Zeigt, ob das digitale Zertifikat im Gerät vorhanden ist.</p> <p>Mögliche Werte:</p> <ul style="list-style-type: none"> ▶ <code>Certificate present</code> Das Zertifikat ist vorhanden. ▶ <code>No certificate present</code> Das Zertifikat wurde entfernt. ▶ <code>Certificate will be created ...</code> Das Zertifikat wird auf dem Gerät erzeugt. ▶ <code>Certificate created</code> Das Zertifikat ist auf dem Gerät erzeugt.

Parameter	Bedeutung
Erzeugen	<p>Erzeugt ein digitales Zertifikat auf dem Gerät.</p> <p>Damit der Server dieses Zertifikat verwendet, klicken Sie die Schaltfläche „Erzeugen“ und starten Sie den Server neu über die Schaltfläche „Webserver neu starten“.</p> <p>Alternativ haben Sie die Möglichkeit, ein eigenes Zertifikat in das Gerät zu kopieren.</p>
Löschen	<p>Entfernt das digitale Zertifikat.</p> <p>Um das Zertifikat endgültig vom Gerät zu entfernen, speichern Sie die Änderungen. Dabei schaltet das Gerät den HTTPS-Server aus.</p>
Datei	<p>Legt Pfad und Dateiname des Zertifikats fest. Zulässig sind X.509-Zertifikate (PEM).</p> <p>Das Gerät bietet Ihnen folgende Möglichkeiten, das Zertifikat in das Gerät zu kopieren:</p> <ul style="list-style-type: none"> ▶ Import vom PC Befindet sich das Zertifikat auf Ihrem PC oder auf einem Netzlaufwerk, markieren Sie die zu importierende Datei und ziehen Sie sie per Drag-and-Drop in das gestrichelt umrandete Feld. Diese Möglichkeit unterstützen die gängigen Web-Browser mit Ausnahme des Internet Explorer. ▶ Import von einem TFTP-Server Befindet sich der Schlüssel auf einem TFTP-Server, geben Sie den URL zur Datei in folgender Form ein: <code>tftp://<IP address>/<Path>/<File name></code>
Upload	<p>Befindet sich das Zertifikat auf Ihrem PC oder auf einem Netzlaufwerk, markieren Sie die zu importierende Datei und ziehen Sie sie per Drag-and-Drop in das gestrichelt umrandete Feld.</p>
Importieren	<p>Kopiert das Zertifikat in das Gerät.</p> <p>Damit der Server dieses Zertifikat verwendet, klicken Sie die Schaltfläche „Schreiben“ und starten Sie den Server neu.</p>
Webserver neu starten	<p>Startet den HTTPS-Server des Gerätes neu.</p>

Anmerkung: Ihr Webbrowser zeigt beim Laden der grafischen Benutzeroberfläche eine Warnung, wenn Sie ein Zertifikat ohne Verifizierung durch eine Zertifizierungsorganisation verwenden. Um die grafische Benutzeroberfläche zu laden, fügen Sie im Webbrowser eine Ausnahmeregel für das Zertifikat hinzu.

■ Schaltflächen

	Beendet die Sitzung und trennt die Verbindung zum Gerät.
	Alphanumerische ASCII-Zeichenfolge mit 0..64 Zeichen
	Zeigt die Zeit in Sekunden, nach der das Gerät bei Inaktivität des Benutzers die Sitzung automatisch beendet.
Laden	Lädt die Anzeige der Seite in Ihrem Web-Browser neu.
Schreiben	Überträgt die Änderungen in den flüchtigen Speicher des Gerätes. Um die Änderungen im nicht-flüchtigen lokalen Speicher des Gerätes zu speichern, gehen Sie wie folgt vor: <ul style="list-style-type: none"> <input type="checkbox"/> Öffnen Sie den Dialog Grundeinstellungen > Laden/Speichern. <input type="checkbox"/> Klicken Sie „Speichern“ im Rahmen „Laden/Speichern“ neben „Aktuelle Konfiguration speichern“.
Hilfe	Öffnet die Online-Hilfe.

11.2.3 Gerätesicherheit > SNMP

Dieser Dialog bietet Ihnen die Möglichkeit, Einstellungen für den SNMP-Agenten des Gerätes festzulegen und den Zugriff auf das Gerät mit unterschiedlichen SNMP-Versionen ein-/auszuschalten.

Der SNMP-Agent ermöglicht den Zugriff auf die Management-Funktionen des Gerätes mit SNMP-basierten Anwendungen, z. B. mit der grafischen Benutzeroberfläche.

■ Konfiguration

Parameter	Bedeutung
SNMPv1 ein	<p>Aktiviert/deaktiviert den Zugriff auf das Gerät per SNMP Version 1.</p> <p>Mögliche Werte:</p> <ul style="list-style-type: none"> ▶ <code>marked</code> (Voreinstellung) Zugriff aktiviert ▶ <code>unmarked</code> Zugriff deaktiviert <p>Die Community-Namen legen Sie fest im Rahmen <code>SNMPv1/v2 Community</code>.</p>
SNMPv2 ein	<p>Aktiviert/deaktiviert den Zugriff auf das Gerät per SNMP Version 2.</p> <p>Mögliche Werte:</p> <ul style="list-style-type: none"> ▶ <code>marked</code> (Voreinstellung) Zugriff aktiviert ▶ <code>unmarked</code> Zugriff deaktiviert <p>Die Community-Namen legen Sie fest im Rahmen <code>SNMPv1/v2 Community</code>.</p>
SNMPv3 ein	<p>Aktiviert/deaktiviert den Zugriff auf das Gerät per SNMP Version 3.</p> <p>Mögliche Werte:</p> <ul style="list-style-type: none"> ▶ <code>marked</code> (Voreinstellung) Zugriff aktiviert ▶ <code>unmarked</code> Zugriff deaktiviert <p>Diese Funktion verwendet z. B. die Netzmanagement-Software Industrial HiVision, um Änderungen an den Einstellungen durchzuführen.</p>

Parameter	Bedeutung
Port-Nummer	<p>Legt die Nummer des UDP-Ports fest, auf dem der SNMP-Agent Anfragen von Clients entgegen nimmt.</p> <p>Mögliche Werte:</p> <ul style="list-style-type: none"> ▶ 1..65535 (Voreinstellung: 161) <p>Damit der SNMP-Agent nach einer Änderung den neuen Port verwendet, verfahren Sie wie folgt:</p> <ul style="list-style-type: none"> <input type="checkbox"/> Klicken Sie die Schaltfläche „Schreiben“. <input type="checkbox"/> Klicken Sie im Dialog <i>Grundeinstellungen > Laden/Speichern</i> die Schaltfläche „Speichern“ neben „Aktuelle Konfiguration speichern“. <input type="checkbox"/> Starten Sie das Gerät neu.

■ SNMPv1/v2 Community

Dieser Rahmen zeigt die Berechtigung für SNMPv1/v2-Anwendungen auf dem Gerät:



- ▶ **Read**
Bei Anfragen mit dem nebenstehenden Community-Namen erhält die Anwendung Leserechte auf dem Gerät.
- ▶ **Write**
Bei Anfragen mit dem nebenstehenden Community-Namen erhält die Anwendung Lese- und Schreibrechte auf dem Gerät.

Parameter	Bedeutung
Lesen	<p>Legt den Community-Namen für die nebenstehende Berechtigung fest.</p> <p>Mögliche Werte:</p> <ul style="list-style-type: none"> ▶ Alphanumerische ASCII-Zeichenfolge mit 0..32 Zeichen <i>public</i> (Voreinstellung für Leserechte)
Schreiben	<p>Legt den Community-Namen für die nebenstehende Berechtigung fest.</p> <p>Mögliche Werte:</p> <ul style="list-style-type: none"> ▶ Alphanumerische ASCII-Zeichenfolge mit 0..32 Zeichen <i>private</i> (Voreinstellung für Lese- und Schreibrechte)

■ Schaltflächen



Beendet die Sitzung und trennt die Verbindung zum Gerät.

	Alphanumerische ASCII-Zeichenfolge mit 0..64 Zeichen
	Zeigt die Zeit in Sekunden, nach der das Gerät bei Inaktivität des Benutzers die Sitzung automatisch beendet.
Laden	Lädt die Anzeige der Seite in Ihrem Web-Browser neu.
Schreiben	Überträgt die Änderungen in den flüchtigen Speicher des Gerätes. Um die Änderungen im nicht-flüchtigen lokalen Speicher des Gerätes zu speichern, gehen Sie wie folgt vor: <ul style="list-style-type: none"><input type="checkbox"/> Öffnen Sie den Dialog Grundeinstellungen > Laden/Speichern.<input type="checkbox"/> Klicken Sie „Speichern“ im Rahmen „Laden/Speichern“ neben „Aktuelle Konfiguration speichern“.
Hilfe	Öffnet die Online-Hilfe.



11.3 Zeit

Das Simple Network Time Protocol (SNTP) ist ein im RFC 4330 beschriebenes Verfahren für die Zeitsynchronisation im Netz. Das Gerät bietet Ihnen die Möglichkeit, als SNTP-Client die Systemzeit im Gerät zu synchronisieren.

11.3.1 Zeit > Grundeinstellungen

Parameter	Bedeutung
Systemzeit (UTC)	Zeigt das gegenwärtige Datum und die gegenwärtige Uhrzeit bezogen auf die koordinierte Weltzeit UTC.
Systemzeit	Zeigt das aktuelle Datum und die aktuelle Uhrzeit bezogen auf die lokale Zeit an: „Systemzeit“ = „Systemzeit (UTC)“ + „Lokaler Offset [min]“
Quelle der Zeit	<p>Zeigt die Zeitquelle, aus der das Gerät die Zeitinformation bezieht. Das Gerät wählt automatisch die verfügbare Zeitquelle mit der höchsten Genauigkeit.</p> <p>Mögliche Werte:</p> <ul style="list-style-type: none"> ▶ lokal Systemuhr des Geräts. ▶ sntp Der SNTP-Client ist aktiviert und das Gerät ist durch einen SNTP-Server synchronisiert.
Lokaler Offset [min]	<p>Legt die Differenz zwischen lokaler Zeit und „Systemzeit (UTC)“ in Minuten fest: „Lokaler Offset [min]“ = „Systemzeit“ – „Systemzeit (UTC)“</p> <p>Mögliche Werte:</p> <ul style="list-style-type: none"> ▶ -780 . . 840 (Voreinstellung: 60)
Setze Zeit vom PC	Das Gerät verwendet die Uhrzeit des PCs als Systemzeit.

■ Schaltflächen

	Beendet die Sitzung und trennt die Verbindung zum Gerät.
	Alphanumerische ASCII-Zeichenfolge mit 0..64 Zeichen
	Zeigt die Zeit in Sekunden, nach der das Gerät bei Inaktivität des Benutzers die Sitzung automatisch beendet.
Laden	Lädt die Anzeige der Seite in Ihrem Web-Browser neu.
Schreiben	Überträgt die Änderungen in den flüchtigen Speicher des Gerätes. Um die Änderungen im nicht-flüchtigen lokalen Speicher des Gerätes zu speichern, gehen Sie wie folgt vor: <ul style="list-style-type: none"> <input type="checkbox"/> Öffnen Sie den Dialog Grundeinstellungen > Laden/Speichern. <input type="checkbox"/> Klicken Sie „Speichern“ im Rahmen „Laden/Speichern“ neben „Aktuelle Konfiguration speichern“.
Hilfe	Öffnet die Online-Hilfe.

11.3.2 Zeit > SNTP

■ Operation

Parameter	Bedeutung
Operation	Schaltet den SNTP Client-Funktion im Gerät ein/aus. <p>Mögliche Werte:</p> <ul style="list-style-type: none"> ▶ On Die SNTP Client-Funktion ist eingeschaltet. Das Gerät arbeitet als SNTP-Client. ▶ Off Die SNTP Client-Funktion ist ausgeschaltet.

■ Konfiguration

Parameter	Bedeutung
Modus	<p>Legt fest, ob das Gerät die Zeitinformation aktiv bei einem im Netz bekannten und konfigurierten SNTP-Server anfragt (Unicast-Modus) oder passiv auf die Zeitinformation eines beliebigen SNTP-Servers wartet (Broadcast-Modus).</p> <p>Mögliche Werte:</p> <ul style="list-style-type: none"> ▶ <code>unicast</code> (Voreinstellung) Das Gerät bezieht die Zeitinformation ausschließlich vom konfigurierten SNTP-Server. Das Gerät sendet Unicast-Anfragen an den SNTP-Server und wertet dessen Antworten aus. ▶ <code>broadcast</code> Das Gerät bezieht die Zeitinformation von einem oder mehreren SNTP- oder NTP-Servern. Das Gerät wertet ausschließlich die Broadcasts oder Multicasts dieser Server aus.
Request-Intervall [s]	<p>Legt das Intervall in Sekunden fest, in dem das Gerät Zeitinformationen beim SNTP-Server anfordert.</p> <p>Mögliche Werte:</p> <ul style="list-style-type: none"> ▶ <code>5..3600</code> (Voreinstellung: 30)
Broadcast-Recv-Timeout [s]	<p>Legt die Zeit in Sekunden fest, die ein Client im Broadcast-Client-Modus wartet, bevor er den Wert im Feld von <code>syncToRemoteServer</code> zu <code>notSynchronized</code> ändert, wenn der Client keine Broadcast-Pakete empfängt.</p> <p>Mögliche Werte:</p> <ul style="list-style-type: none"> ▶ <code>128..2048</code> (Voreinstellung: 3)
Deaktiviere Client nach erfolgreicher Synchronisierung	<p>Aktiviert/deaktiviert das Ausschalten des SNTP-Clients, wenn das Gerät die Zeit erfolgreich synchronisiert hat.</p> <p>Mögliche Werte:</p> <ul style="list-style-type: none"> ▶ <code>marked</code> Das Ausschalten des SNTP-Clients ist aktiv. Das Gerät deaktiviert den SNTP-Client nach erfolgreicher Synchronisation der Zeit. ▶ <code>unmarked</code> (Voreinstellung) Das Ausschalten des SNTP-Clients ist aktiv. Der SNTP-Client bleibt nach erfolgreicher Synchronisation der Zeit aktiv.

■ Status



Parameter	Bedeutung
Status	<p>Zeigt den Zustand des SNTP-Clients.</p> <p>Mögliche Werte:</p> <ul style="list-style-type: none"> ▶ <code>disabled</code> Der SNTP-Client ist deaktiviert. ▶ <code>notSynchronized</code> Der SNTP-Client ist auf keinen SNTP- oder NTP-Server synchronisiert. ▶ <code>synchronizedToRemoteServer</code> Der SNTP-Client ist auf einen SNTP- oder NTP-Server synchronisiert.

■ Tabelle

Parameter	Bedeutung
Index	<p>Zeigt die Index-Nummer, auf die sich der Tabelleneintrag bezieht.</p> <p>Mögliche Werte:</p> <ul style="list-style-type: none"> ▶ <code>1..2</code> Das Gerät legt diese Nummer automatisch fest. <p>Wenn Sie einen Tabelleneintrag löschen, bleibt eine Lücke in der Nummerierung. Wenn Sie einen neuen Tabelleneintrag erzeugen, schließt das Gerät die 1. Lücke.</p> <p>Das Gerät sendet nach dem Starten Anfragen an den SNTP-Server, der im 1. Tabelleneintrag konfiguriert ist. Bleibt die Antwort des Servers aus, sendet das Gerät seine Anfragen an den SNTP-Server, der im nächsten Tabelleneintrag konfiguriert ist.</p> <p>Antwortet vorübergehend keiner der konfigurierten SNTP-Server, verliert der SNTP-Client seine Synchronisation. Das Gerät fragt solange zyklisch nacheinander bei jedem SNTP-Server an, bis ein Server eine gültige Zeit liefert. Das Gerät synchronisiert sich auf diesen SNTP-Server, auch wenn die anderen Server später wieder erreichbar sind.</p>
Name	<p>Legt die Bezeichnung des SNTP-Servers fest.</p> <p>Mögliche Werte:</p> <ul style="list-style-type: none"> ▶ Alphanumerische ASCII-Zeichenfolge mit 1..32 Zeichen
Adresse	<p>Legt die IP-Adresse des SNTP-Servers fest.</p> <p>Mögliche Werte:</p> <ul style="list-style-type: none"> ▶ Gültige IPv4-Adresse oder Hostname (Voreinstellung: <code>0.0.0.0</code>)

Parameter	Bedeutung
UDP-Zielport	<p>Legt den UDP-Port fest, auf dem der SNTP-Server die Zeitinformationen erwartet.</p> <p>Mögliche Werte:</p> <ul style="list-style-type: none"> ▶ 1..65535 (Voreinstellung: 123)
Status	<p>Zeigt den Verbindungsstatus zwischen SNTP-Client und SNTP-Server.</p> <p>Mögliche Werte:</p> <ul style="list-style-type: none"> ▶ success Das Gerät hat die Zeit erfolgreich mit dem SNTP-Server synchronisiert. ▶ badDateEncoded Die empfangene Zeitinformation enthält Protokollfehler, Synchronisation fehlgeschlagen. ▶ other <ul style="list-style-type: none"> – Für die IP-Adresse des SNTP-Servers ist der Wert 0.0.0.0 eingetragen, Synchronisation fehlgeschlagen. oder – Der SNTP-Client verwendet einen anderen SNTP-Server. ▶ requestTimedOut Das Gerät hat keine Antwort vom SNTP-Server erhalten, Synchronisation fehlgeschlagen. ▶ serverKissOfDeath Der SNTP-Server ist überlastet. Das Gerät ist aufgefordert, sich mit einem anderen SNTP-Server zu synchronisieren. Steht kein anderer SNTP-Server zur Verfügung, fragt das Gerät in größeren Abständen als im Feld Request-Intervall [s] eingestellt nach, ob der Server noch überlastet ist. ▶ serverUnsyncronized Der SNTP-Server ist weder auf eine lokale noch auf eine externe Referenzzeitquelle synchronisiert, Synchronisation fehlgeschlagen. ▶ versionNotSupported Die SNTP-Versionen auf Client und Server sind zueinander inkompatibel, Synchronisation fehlgeschlagen.
Aktiv	<p>Aktiviert/deaktiviert die Verbindung zum SNTP-Server.</p> <p>Mögliche Werte:</p> <ul style="list-style-type: none"> ▶ marked Die Verbindung zum SNTP-Server ist aktiviert. Der SNTP-Client hat Zugriff auf den SNTP-Server. ▶ unmarked (Voreinstellung) Die Verbindung zum SNTP-Server ist deaktiviert. Der SNTP-Client hat keinen Zugriff auf den SNTP-Server.

■ Schaltflächen

	Beendet die Sitzung und trennt die Verbindung zum Gerät.
	Startet das Gerät neu.
	Zeigt die Zeit in Sekunden, nach der das Gerät bei Inaktivität des Benutzers die Sitzung automatisch beendet.
Laden	Lädt die Anzeige der Seite in Ihrem Web-Browser neu.
Schreiben	Überträgt die Änderungen in den flüchtigen Speicher des Gerätes. Um die Änderungen im nicht-flüchtigen lokalen Speicher des Gerätes zu speichern, gehen Sie wie folgt vor: <ul style="list-style-type: none"> <input type="checkbox"/> Öffnen Sie den Dialog Grundeinstellungen > Laden/Speichern. <input type="checkbox"/> Klicken Sie „Speichern“ im Rahmen „Laden/Speichern“ neben „Aktuelle Konfiguration speichern“.
Server hinzufügen	Fügt einen neuen Tabelleneintrag hinzu.
Hilfe	Öffnet die Online-Hilfe.

11.4 Switching

Dieses Menü bietet Ihnen die Möglichkeit, die Einstellungen für den Zugriff auf das Gerät festzulegen.

11.4.1 Switching > Filter für MAC-Adressen

Dieser Dialog bietet Ihnen die Möglichkeit, Adressfilter für die Adresstabelle (Forwarding Database) anzuzeigen und zu bearbeiten. Adressfilter legen die Vermittlungsweise der Datenpakete im Gerät anhand der Ziel-MAC-Adresse fest.

Jede Zeile in der Tabelle stellt einen Filter dar. Das Gerät richtet die Filter automatisch ein. Das Gerät bietet Ihnen die Möglichkeit, von Hand weitere Filter einzurichten.

Das Gerät vermittelt die Datenpakete wie folgt:

- ▶ Enthält die Tabelle einen Eintrag für die Zieladresse eines Datenpakets, vermittelt das Gerät das Datenpaket vom Empfangsport an die im Tabelleneintrag angegebenen Ports.
- ▶ Existiert kein Tabelleneintrag für die Zieladresse, vermittelt das Gerät das Datenpaket vom Empfangsport an alle anderen Ports.



■ Tabelle

Parameter	Bedeutung
Adresse	Zeigt die Ziel-MAC-Adresse, für die der Tabelleneintrag gilt.

Parameter	Bedeutung
Status	Zeigt, auf welche Weise das Gerät den Adressfilter eingerichtet hat. Mögliche Werte: <ul style="list-style-type: none"> ▶ <code>learned</code> Adressfilter automatisch durch das Gerät eingerichtet anhand empfangener Datenpakete. ▶ <code>static</code> Adressfilter manuell eingerichtet. Der Adressfilter bleibt dauerhaft eingerichtet.
Port	Zeigt den Geräte-Port, der dem Tabelleneintrag zugewiesen ist.
Löschen	Löscht die nebenstehende Zieladresse aus der MAC-Adresstabelle.

Um alle gelernten MAC-Adressen aus der Adresstabelle (Forwarding Database) zu entfernen, klicken Sie die Schaltfläche „MAC-Adresstabelle zurücksetzen“.

■ Schaltflächen

	Beendet die Sitzung und trennt die Verbindung zum Gerät.
	Alphanumerische ASCII-Zeichenfolge mit 0..64 Zeichen
	Zeigt die Zeit in Sekunden, nach der das Gerät bei Inaktivität des Benutzers die Sitzung automatisch beendet.
Laden	Lädt die Anzeige der Seite in Ihrem Web-Browser neu.
MAC-Adresstabelle zurücksetzen	Entfernt aus der Forwarding-Tabelle (FDB) die MAC-Adressen, die im Feld „Status“ den Wert <code>learned</code> haben.
Erzeugen	Öffnet den Dialog „Eintrag erstellen“, um der Tabelle einen neuen Eintrag hinzuzufügen. <ul style="list-style-type: none"> ▶ Im Feld „Adresse“ legen Sie die Ziel-MAC-Adresse fest. ▶ Im Feld „Mögliche Ports“ legen Sie den Geräte-Port fest. <ul style="list-style-type: none"> – Wählen Sie einen Port aus, wenn die Ziel-MAC-Adresse eine Unicast-Adresse ist. – Wählen Sie einen oder mehrere Ports aus, wenn die Ziel-MAC-Adresse eine Multicast-Adresse ist. – Wählen Sie keinen Port aus, um einen Discard-Filter einzurichten. Das Gerät verwirft Datenpakete mit der im Tabelleneintrag angegebenen Ziel-MAC-Adresse.
Hilfe	Öffnet die Online-Hilfe.

11.4.2 QoS/Priorität

Kommunikationsnetze übertragen gleichzeitig eine Vielzahl von Anwendungen, die jeweils unterschiedliche Anforderungen an Verfügbarkeit, Bandbreite und Latenzzeiten haben.

QoS (Quality of Service) ist ein in der Norm IEEE 802.1D beschriebenes Verfahren. Sie wird zur Verteilung von Ressourcen im Netzwerk verwendet. Sie haben damit die Möglichkeit, wichtigen Anwendungen eine Mindest-Bandbreite zur Verfügung zu stellen. Voraussetzung ist, dass die Endgeräte und die Geräte im Netz die priorisierte Datenübertragung unterstützen. Hochpriorisierte Datenpakete vermitteln die Geräte im Netz bevorzugt. Datenpakete mit niedriger Priorität vermitteln sie, wenn keine höher priorisierten Datenpakete zu vermitteln sind.

Das Gerät bietet Ihnen folgende Einstellmöglichkeiten:

- ▶ Für eingehende Datenpakete legen Sie fest, wie das Gerät die QoS-/Priorisierungs-Information auswertet.
- ▶ Für ausgehende Datenpakete legen Sie fest, welche QoS-/Priorisierungs-Information das Gerät in das Datenpaket schreibt (z. B. Priorität für Management-Pakete, Portpriorität).

11.4.3 Switching > QoS/Priorität > Port-Konfiguration

In diesem Dialog legen Sie für jeden Geräte-Port die QoS-/Priorisierungseinstellungen für empfangene Datenpakete fest.



■ Tabelle

Parameter	Bedeutung
Port	Zeigt die Nummer des Geräte-Ports.

Parameter	Bedeutung
Port-Priorität	<p>Legt die VLAN-Priorität der Datenpakete fest, die der Port empfängt.</p> <p>Das Gerät wendet diese Einstellung abhängig vom Wert in der Spalte „Trust-Modus“ auf die Datenpakete an:</p> <ul style="list-style-type: none"> – „Trust-Mode“ = <code>untrusted</code> Das Gerät vermittelt das Datenpaket mit der hier festgelegten VLAN-Priorität. – „Trust-Mode“ = <code>trustDot1p</code> Wenn das Datenpaket keine VLAN- oder Prioritätsmarkierung enthält, vermittelt das Gerät das Datenpaket mit der hier festgelegten VLAN-Priorität. – „Trust-Mode“ = <code>trustIpDscp</code> Wenn das Datenpaket kein IP-Paket ist, vermittelt das Gerät das Datenpaket mit der hier festgelegten Priorität. <p>Mögliche Werte:</p> <ul style="list-style-type: none"> ▶ 0..7 (Voreinstellung: 0) <p>Im Dialog <code>Switching > QoS/Priorität > 802.1D/p-Mapping</code> weisen Sie jeder VLAN-Priorität eine Verkehrsklasse zu. Abhängig von der VLAN-Priorität weist das Gerät das Datenpaket einer bestimmten Verkehrsklasse zu und dementsprechend einer bestimmten Warteschlange des Ports.</p>
Trust Modus	<p>Legt fest, wie das Gerät empfangene Datenpakete behandelt, die eine QoS-/Prioritätsinformation enthalten.</p> <p>Mögliche Werte:</p> <ul style="list-style-type: none"> ▶ <code>untrusted</code> Das Gerät vermittelt das Datenpaket mit der im Feld „Port-Priorität“ festgelegten VLAN-Priorität. Die im Datenpaket enthaltene QoS-/Prioritätsinformation ignoriert das Gerät. ▶ <code>trustDot1p</code> (Voreinstellung) <ul style="list-style-type: none"> – Wenn das Datenpaket eine VLAN-Markierung enthält, vermittelt das Gerät das Datenpaket anhand der enthaltenen QoS-/Prioritätsinformation. Im Dialog <code>Switching > QoS/Priorität > 802.1D/p-Mapping</code> weisen Sie jeder VLAN-Priorität eine Verkehrsklasse zu. Abhängig von der VLAN-Priorität weist das Gerät das Datenpaket einer bestimmten Verkehrsklasse zu und dementsprechend einer bestimmten Warteschlange des Ports. – Wenn das Datenpaket keine VLAN-Markierung enthält, vermittelt das Gerät das Datenpaket mit der im Feld „Port-Priorität“ festgelegten VLAN-Priorität. ▶ <code>trustIpDscp</code> <ul style="list-style-type: none"> – Wenn das Datenpaket ein IP-Datenpaket ist, vermittelt das Gerät das Datenpaket anhand des enthaltenen IP-DSCP-Werts. Im Dialog <code>Switching > QoS/Priorität > IP-DSCP-Mapping</code> weisen Sie jedem IP-DSCP-Wert eine Verkehrsklasse zu. Abhängig vom IP-DSCP-Wert weist das Gerät das Datenpaket einer bestimmten Verkehrsklasse zu und dementsprechend einer bestimmten Warteschlange des Ports. – Wenn das Datenpaket kein IP-Datenpaket ist, vermittelt das Gerät das Datenpaket mit der im Feld „Port-Priorität“ festgelegten VLAN-Priorität.

Parameter	Bedeutung
Untrusted Traffic Class	<p>Zeigt die Verkehrsklasse. Das Gerät weist Datenpakete dieser Verkehrsklasse zu, wenn im Feld „Trust-Mode“ der Wert <code>untrusted</code> festgelegt ist.</p> <p>Mögliche Werte:</p> <ul style="list-style-type: none"> ▶ 0..3 <p>Im Dialog <code>Switching > QoS/Priorität > 802.1D/p-Mapping</code> weisen Sie jeder VLAN-Priorität eine Verkehrsklasse zu. Abhängig von der VLAN-Priorität weist das Gerät das Datenpaket einer bestimmten Verkehrsklasse zu und dementsprechend einer bestimmten Warteschlange des Ports.</p>

■ Schaltflächen

	Beendet die Sitzung und trennt die Verbindung zum Gerät.
	Alphanumerische ASCII-Zeichenfolge mit 0..64 Zeichen
	Zeigt die Zeit in Sekunden, nach der das Gerät bei Inaktivität des Benutzers die Sitzung automatisch beendet.
Laden	Lädt die Anzeige der Seite in Ihrem Web-Browser neu.
Schreiben	<p>Überträgt die Änderungen in den flüchtigen Speicher des Gerätes. Um die Änderungen im nicht-flüchtigen lokalen Speicher des Gerätes zu speichern, gehen Sie wie folgt vor:</p> <ul style="list-style-type: none"> <input type="checkbox"/> Öffnen Sie den Dialog <code>Grundeinstellungen > Laden/Speichern</code>. <input type="checkbox"/> Klicken Sie „Speichern“ im Rahmen „Laden/Speichern“ neben „Aktuelle Konfiguration speichern“.
Hilfe	Öffnet die Online-Hilfe.

11.4.4 Switching > QoS/Priorität > 802.1D/p-Mapping

Das Gerät vermittelt Datenpakete mit VLAN-Tag anhand der enthaltenen QoS-/Priorisierungsinformation mit hoher oder mit niedriger Priorität.

In diesem Dialog weisen Sie jeder VLAN-Priorität eine Verkehrsklasse zu. Die Verkehrsklassen sind den Warteschlangen der Ports (Prioritäts-Queues) fest zugewiesen.

■ Tabelle



Parameter	Bedeutung
VLAN-Priorität	Zeigt die VLAN-Priorität.
Traffic-Class	Legt die Verkehrsklasse fest, die der VLAN-Priorität zugewiesen ist. Mögliche Werte: ▶ 0 . . 3 0 ist der Warteschlange mit der niedrigsten Priorität zugeordnet. 3 ist der Warteschlange mit der höchsten Priorität zugeordnet. Anmerkung: Netzmanagementprotokolle und Redundanzmechanismen nutzen die höchste Verkehrsklasse. Wählen Sie deshalb für Anwendungsdaten eine andere Verkehrsklasse.

■ Werksseitige Zuweisung der VLAN-Priorität zu Verkehrsklassen

VLAN-Priorität	Traffic Class	Inhaltskennzeichnung gemäß IEEE 802.1D
0	1	Standard Normale Daten
1	0	Hintergrund Zeitunkritische Daten und Hintergrunddienste
2	0	Hintergrund Zeitunkritische Daten und Hintergrunddienste
3	1	Standard Normale Daten
4	2	Best Effort Normale Daten ohne Priorisierung
5	2	Best Effort Normale Daten ohne Priorisierung

VLAN-Priorität	Traffic Class	Inhaltskennzeichnung gemäß IEEE 802.1D
6	3	Excellent Effort Wichtige Daten
7	3	Excellent Effort Wichtige Daten

■ Schaltflächen

	Beendet die Sitzung und trennt die Verbindung zum Gerät.
	Alphanumerische ASCII-Zeichenfolge mit 0..64 Zeichen
	Zeigt die Zeit in Sekunden, nach der das Gerät bei Inaktivität des Benutzers die Sitzung automatisch beendet.
Laden	Lädt die Anzeige der Seite in Ihrem Web-Browser neu.
Schreiben	Überträgt die Änderungen in den flüchtigen Speicher des Gerätes. Um die Änderungen im nicht-flüchtigen lokalen Speicher des Gerätes zu speichern, gehen Sie wie folgt vor: <ul style="list-style-type: none"> <input type="checkbox"/> Öffnen Sie den Dialog Grundeinstellungen > Laden/Speichern. <input type="checkbox"/> Klicken Sie „Speichern“ im Rahmen „Laden/Speichern“ neben „Aktuelle Konfiguration speichern“.
Hilfe	Öffnet die Online-Hilfe.

11.4.5 QoS/Priorität > IP-DSCP-Mapping



Das Gerät vermittelt IP-Datenpakete anhand des im Datenpaket enthaltenen DSCP-Werts mit hoher oder mit niedriger Priorität.

In diesem Dialog weisen Sie jedem DSCP-Wert eine Verkehrsklasse zu. Die Verkehrsklassen sind den Warteschlangen der Ports (Prioritäts-Queues) fest zugewiesen.

■ Tabelle

Parameter	Bedeutung
DSCP Wert	Zeigt den DSCP-Wert.
Traffic-Class	Legt die Verkehrsklasse fest, die dem DSCP-Wert zugewiesen ist. Mögliche Werte: ▶ 0..3 0 ist der Warteschlange mit der niedrigsten Priorität zugeordnet. 3 ist der Warteschlange mit der höchsten Priorität zugeordnet.

■ Schaltflächen

	Beendet die Sitzung und trennt die Verbindung zum Gerät.
	Alphanumerische ASCII-Zeichenfolge mit 0..64 Zeichen
	Zeigt die Zeit in Sekunden, nach der das Gerät bei Inaktivität des Benutzers die Sitzung automatisch beendet.
Laden	Lädt die Anzeige der Seite in Ihrem Web-Browser neu.
Schreiben	Überträgt die Änderungen in den flüchtigen Speicher des Gerätes. Um die Änderungen im nicht-flüchtigen lokalen Speicher des Gerätes zu speichern, gehen Sie wie folgt vor: <input type="checkbox"/> Öffnen Sie den Dialog Grundeinstellungen > Laden/Speichern . <input type="checkbox"/> Klicken Sie „Speichern“ im Rahmen „Laden/Speichern“ neben „Aktuelle Konfiguration speichern“.
Hilfe	Öffnet die Online-Hilfe.

- Werksseitige Zuweisung der DSCP-Werte zu Verkehrsklassen

DSCP-Wert	Traffic Class
0-7	1
8-23	0
24-31	1
32-47	2
48-63	3

11.4.6 Switching > VLAN

Mit VLAN (Virtual Local Area Network) verteilen Sie den Datenverkehr im physischen Netz auf logische Teilnetze. Das bietet Ihnen folgende Vorteile:

- ▶ Hohe Flexibilität
 - Mit VLAN verteilen Sie den Datenverkehr auf logische Netze in der vorhandenen Infrastruktur.
Ohne VLAN wären dazu weitere Geräte und eine aufwendigere Verkabelung notwendig.
 - Mit VLAN definieren Sie Netzsegmente unabhängig vom Standort der einzelnen Endgeräte.
- ▶ Verbesserter Durchsatz
 - Datenpakete lassen sich in VLANs priorisiert übertragen.
Bei höherer Priorisierung überträgt das Gerät die Daten eines VLANs bevorzugt, zum Beispiel mit zeitkritischen Anwendungen wie VoIP-Telefonaten.
 - Die Netzlast reduziert sich erheblich, wenn sich Datenpakete und Broadcasts in kleinen Netzsegmenten anstatt im gesamten Netz ausbreiten.
- ▶ Höhere Sicherheit

Das Verteilen des Datenverkehrs auf einzelne logische Netze erschwert ungewolltes Abhören und härtet das System gegen Angriffe, wie MAC-Flooding oder MAC-Spoofing.

Das Gerät unterstützt gemäß dem Standard IEEE 802.1Q paketbasierte „tagged“ VLANs. Das VLAN-Tag im Datenpaket kennzeichnet, zu welchem VLAN das Datenpaket gehört.

Das Gerät überträgt die markierten Datenpakete eines VLANs ausschließlich auf Ports, die demselben VLAN zugewiesen sind. Dies reduziert die Netzlast.

Das Gerät lernt die MAC-Adressen für jedes VLAN separat (Independent VLAN Learning).

- ▶ Voice-VLAN
- ▶ MAC-basiertes VLAN
- ▶ IP-Subnetz-basiertes VLAN
- ▶ Protokoll-basiertes VLAN
- ▶ Port-basiertes VLAN

11.4.7 Switching> VLAN> Konfiguration

■ VLAN Global

Dieser Dialog ermöglicht Ihnen, sich allgemeine VLAN-Parameter des Geräts anzusehen.

Parameter	Bedeutung
Max. VLAN ID	Größtmögliche ID, die Sie einem VLAN zuweisen können. Siehe Dialog Switching > VLAN > Configuration .
VLAN (max.)	Zeigt die maximale Anzahl der im Gerät einrichtbaren VLANs. Siehe Dialog Switching > VLAN > Configuration .
VLANs	Anzahl der VLANs, die im Gerät gegenwärtig eingerichtet sind. Siehe Dialog Switching > VLAN > Configuration . Das VLAN mit der ID 1 ist stets im Gerät eingerichtet.



■ VLAN Konfiguration

In diesem Dialog verwalten Sie die VLANs. Um ein VLAN einzurichten, erzeugen Sie in der Tabelle eine weitere Zeile. Dort legen Sie für jeden Port fest, ob er Datenpakete des betreffenden VLANs vermittelt und ob die Datenpakete ein VLAN-Tag enthalten.

Parameter	Bedeutung
VLAN ID	ID des VLANs. Das Gerät unterstützt bis zu 64 gleichzeitig eingerichtete VLANs. Mögliche Werte: ▶ 1..4042 (Voreinstellung: 1)
Status	Zeigt, auf welche Weise das VLAN eingerichtet ist. Mögliche Werte: ▶ other VLAN 1 ▶ permanent VLAN eingerichtet durch den Benutzer.
Erstellung Datum	Zeigt, seit wann das VLAN eingerichtet ist. Das Feld zeigt den Zeitstempel der Betriebszeit (System Uptime).
Name	Legt die Bezeichnung des VLANs fest. Mögliche Werte: ▶ Alphanumerische ASCII-Zeichenfolge mit 1..32 Zeichen
<Port-Nummer>	Legt fest, ob der betreffende Port Datenpakete des VLANs vermittelt und ob die Datenpakete eine VLAN-Markierung enthalten. Mögliche Werte: ▶ - (Voreinstellung) Der Port ist kein Mitglied des VLANs und vermittelt keine Datenpakete des VLANs. ▶ T= Tagged Der Port ist Mitglied des VLANs und vermittelt die Datenpakete mit VLAN-Tag. Verwenden Sie diese Einstellung, wenn das angeschlossene Gerät kein VLAN-Tag auswertet, zum Beispiel auf Uplink-Ports. ▶ U= Untagged (Voreinstellung für VLAN 1) Der Port ist Mitglied des VLANs und vermittelt die Datenpakete ohne VLAN-Tag. Verwenden Sie diese Einstellung, wenn das angeschlossene Gerät kein VLAN-Tag auswertet, zum Beispiel auf EndPorts.

Anmerkung: Vergewissern Sie sich, dass der Port, an dem die Netzmanagement-Station angeschlossen ist, Mitglied des VLANs ist, in welchem das Gerät die Management-Daten vermittelt. In der Voreinstellung vermittelt das Gerät die Management-Daten im VLAN 1. Sonst bricht die Verbindung zum Gerät ab, sobald Sie die Änderungen an das Gerät übertragen.

■ Schaltflächen

	Beendet die Sitzung und trennt die Verbindung zum Gerät.
	Alphanumerische ASCII-Zeichenfolge mit 0..64 Zeichen
<input type="text" value="476"/>	Zeigt die Zeit in Sekunden, nach der das Gerät bei Inaktivität des Benutzers die Sitzung automatisch beendet.
Hinzufügen	Fügt einen neuen Tabelleneintrag hinzu.
Laden	Lädt die Anzeige der Seite in Ihrem Web-Browser neu.
Schreiben	Überträgt die Änderungen in den flüchtigen Speicher des Gerätes. Um die Änderungen im nicht-flüchtigen lokalen Speicher des Gerätes zu speichern, gehen Sie wie folgt vor: <ul style="list-style-type: none"> <input type="checkbox"/> Öffnen Sie den Dialog Grundeinstellungen > Laden/Speichern. <input type="checkbox"/> Klicken Sie „Speichern“ im Rahmen „Laden/Speichern“ neben „Aktuelle Konfiguration speichern“.
Hilfe	Öffnet die Online-Hilfe.

11.4.8 Switching> VLAN> Port

In diesem Dialog legen Sie fest, wie das Gerät empfangene Datenpakete behandelt, die kein VLAN-Tag haben oder deren VLAN-Tag von der VLAN-ID des Ports abweicht.

Dieser Dialog ermöglicht Ihnen, den Ports ein VLAN zuzuweisen und damit die Port-VLAN-ID festzulegen.

Dieser Dialog ermöglicht Ihnen, den Ports ein VLAN zuzuweisen und damit die Port-VLAN-ID festzulegen.

Außerdem legen Sie für jeden Port fest, wie das Gerät bei ausgeschaltetem VLAN-Unaware-Modus Datenpakete überträgt, wenn eine der folgenden Situationen eintritt:

- ▶ Der Port empfängt Datenpakete ohne VLAN-Tag.
- ▶ Der Port empfängt Datenpakete mit VLAN-Prioritätsinformation (VLAN-ID 0, priority tagged).
- ▶ Das VLAN-Tag des Datenpaketes weicht ab von der VLAN-ID des Ports.

■ Tabelle

Parameter	Bedeutung
Port	Zeigt die Nummer des Ports.
Port-VLAN-ID	<p>Legt die ID des VLANs fest, die das Gerät Datenpaketen ohne eigenes VLAN-Tag zuweist. Voraussetzung ist, dass Sie in Spalte <code>Acceptable packet types</code> den Wert <code>admitAll</code> festlegen.</p> <p>Mögliche Werte:</p> <ul style="list-style-type: none"> ▶ ID eines bereits eingerichteten VLANs (Voreinstellung: 1)
Akzeptierte Datenpakete	<p>Legt fest, ob der Port empfangene Datenpakete ohne VLAN-Tag überträgt oder verwirft.</p> <p>Mögliche Werte:</p> <ul style="list-style-type: none"> ▶ <code>admitAll</code> (Voreinstellung) Der Port akzeptiert Datenpakete sowohl mit als auch ohne VLAN-Tag. ▶ <code>admitTaggedOnly</code> Der Port akzeptiert ausschließlich Datenpakete, die mit einer VLANID ≥ 1 markiert sind.
Ingress-Filtering	<p>Aktiviert/deaktiviert die Eingangsfilterung.</p> <p>Mögliche Werte:</p> <ul style="list-style-type: none"> ▶ <code>marked</code> Die Eingangsfilterung ist aktiv. Das Gerät vergleicht die im Datenpaket enthaltene VLAN-ID mit den VLANs, in denen der Port Mitglied ist. Siehe Dialog <code>Switching > VLAN > Configuration</code>. Stimmt die VLAN-ID im Datenpaket mit einem dieser VLANs überein, vermittelt das Gerät das Datenpaket. Andernfalls verwirft das Gerät das Datenpaket. ▶ <code>unmarked</code> (Voreinstellung) Die Eingangsfilterung ist inaktiv. Das Gerät vermittelt empfangene Datenpakete, ohne die VLAN-ID zu vergleichen. Demzufolge vermittelt das Gerät auch Datenpakete mit VLAN-ID, in denen der Port kein Mitglied ist.

11.4.9 Switching > L2 Redundancy > Spanning Tree > Global

Dieser Dialog bietet Ihnen die Möglichkeit, die Einstellungen für das Redundanzverfahren zu konfigurieren und zu überwachen.

Das Gerät unterstützt das in der Norm IEEE 802.1D-2004 definierte Rapid Spanning Tree Protocol (RSTP). Dieses Protokoll ist eine Weiterentwicklung des Spanning Tree Protocols (STP) und zu diesem kompatibel.

Das Spanning Tree Protocol (STP) ist ein Protokoll, das redundante Pfade eines Netzes deaktiviert, um Schleifen (Loops) zu vermeiden. Falls auf der Strecke eine Netzkomponente ausfällt, berechnet das Gerät die neue Topologie und aktiviert diese Pfade wieder.

Das Rapid Spanning Tree Protocol ermöglicht schnelles Umschalten auf eine neu berechnete Topologie, ohne dabei bestehende Verbindungen zu unterbrechen.

■ Spanning Tree

Parameter	Bedeutung
Function	Schaltet die Spanning-Tree-Funktion im Gerät ein/aus. Mögliche Werte: ▶ On (Lieferzustand) ▶ Off Das Gerät verhält sich transparent. Empfangene Spanning-Tree-Datenpakete flutet das Gerät wie Multicast-Datenpakete an den Geräte-Ports.

■ Protokollkonfiguration/Information

„Bridge“

Parameter	Bedeutung
Bridge ID	<p>Zeigt die Bridge-ID des Geräts. Das Gerät mit der numerisch niedrigsten Bridge-ID übernimmt die Rolle der Root-Bridge im Netz.</p> <p>Mögliche Werte: ▶ <Bridge-Priorität> / <MAC-Adresse></p>
Priorität	<p>Legt die Bridge-Priorität des Geräts fest.</p> <p>Mögliche Werte: ▶ 0..61440 in 4096er-Schritten (Voreinstellung: 32,768)</p> <p>Weisen Sie dem Gerät die numerisch niedrigste Priorität im Netz zu, um es zur Root-Bridge zu bestimmen.</p>
Hello Time [s]	<p>Legt die Zeit in Sekunden fest zwischen dem Senden zweier Konfigurationsmeldungen (Hello-Datenpakete).</p> <p>Mögliche Werte: ▶ 2</p> <p>Übernimmt das Gerät die Rolle der Root-Bridge, verwenden die anderen Geräte im Netz den hier festgelegten Wert. Andernfalls verwendet das Gerät den von der Root-Bridge vorgegebenenWert, siehe Spalte „Root“.</p>
Forward Delay [s]	<p>Legt die Verzögerungszeit für Zustandswechsel in Sekunden fest.</p> <p>Mögliche Werte: ▶ 4..30 (Voreinstellung: 15)</p> <p>Übernimmt das Gerät die Rolle der Root-Bridge, verwenden die anderen Geräte im Netz den hier festgelegten Wert. Andernfalls verwendet das Gerät den von der Root-Bridge vorgegebenenWert, siehe Spalte „Root“.</p> <p>Im Protokoll RSTP handeln die Bridges Zustandswechsel ohne vorgegebeneVerzögerung aus.</p> <p>Das Protokoll STP verwendet den Parameter, um den Wechsel zwischen den Zuständen <code>disabled</code>, <code>discarding</code>, <code>learning</code>, <code>forwarding</code> zu verzögern.</p>
<p>Die Parameter „Forward Delay“ und „Max Age“ stehen in folgender Beziehung zueinander: $Forward\ Delay \geq (Max\ Age/2) + 1$ Wenn Sie in die Felder einen Wert einfügen, der dieser Beziehung widerspricht, ersetzt das Gerät diese Werte mit den zuletzt gültigen Werten oder mit der Voreinstellung.</p>	

Parameter	Bedeutung
Max Age	<p>Legt die maximal zulässige Astlänge fest, d. h. die Anzahl der Geräte bis zur Root-Bridge.</p> <p>Mögliche Werte:</p> <ul style="list-style-type: none"> ▶ 6..40 (Voreinstellung: 20) <p>Übernimmt das Gerät die Rolle der Root-Bridge, verwenden die anderen Geräte im Netz den hier festgelegten Wert.</p> <p>Andernfalls verwendet das Gerät den von der Root-Bridge vorgegebenen Wert, siehe Spalte „Root“.</p> <p>Das Protokoll STP verwendet den Parameter, um die Gültigkeit von STP-BPDUs in Sekunden festzulegen.</p>

„Root“



Parameter	Bedeutung
Bridge ID	<p>Zeigt die Bridge-ID der gegenwärtigen Root-Bridge.</p> <p>Mögliche Werte:</p> <ul style="list-style-type: none"> ▶ <Bridge-Priorität> / <MAC-Adresse> <p>Die Bridge-ID setzt sich zusammen aus Bridge-Priorität und MAC-Adresse.</p>
Priorität	<p>Zeigt die Bridge-Priorität der gegenwärtigen Root-Bridge.</p> <p>Mögliche Werte:</p> <ul style="list-style-type: none"> ▶ 0..61440 in 4096er-Schritten
Hello Time [s]	<p>Zeigt die von der Root-Bridge vorgegebene Zeit in Sekunden zwischen dem Senden zweier Konfigurationsmeldungen (Hello-Datenpakete).</p> <p>Mögliche Werte:</p> <ul style="list-style-type: none"> ▶ 1..2 <p>Das Gerät verwendet diesen vorgegebenen Wert, siehe Spalte „Bridge“.</p>
Forward Delay [s]	<p>Zeigt die von der Root-Bridge vorgegebene Verzögerungszeit für Zustandswechsel in Sekunden.</p> <p>Mögliche Werte:</p> <ul style="list-style-type: none"> ▶ 4..30 <p>Das Gerät verwendet diesen vorgegebenen Wert, siehe Spalte „Bridge“.</p> <p>Im Protokoll RSTP handeln die Bridges Zustandswechsel ohne vorgegebene Verzögerung aus.</p> <p>Das Protokoll STP verwendet den Parameter, um den Wechsel zwischen den Zuständen <code>disabled</code>, <code>discarding</code>, <code>learning</code>, <code>forwarding</code> zu verzögern.</p>

Parameter	Bedeutung
Max Age	<p>Zeigt die von der Root-Bridge vorgegebene maximal zulässige Astlänge, d. h. die Anzahl der Geräte bis zur Root-Bridge.</p> <p>Mögliche Werte:</p> <ul style="list-style-type: none"> ▶ 6..40 (Voreinstellung: 20) <p>Das Protokoll STP verwendet den Parameter, um die Gültigkeit von STP-BPDUs in Sekunden festzulegen.</p>

„Topologie“

Parameter	Bedeutung
Bridge ist Root	<p>Zeigt, ob das Gerät gegenwärtig die Rolle der Root-Bridge übernimmt.</p> <p>Mögliche Werte:</p> <ul style="list-style-type: none"> ▶ unmarkiert Gegenwärtig übernimmt ein anderes Gerät die Rolle der Root-Bridge. ▶ markiert Das Gerät übernimmt gegenwärtig die Rolle der Root-Bridge.
Root-Port	<p>Zeigt die Nummer des Geräte-Ports, von dem der aktuelle Pfad zur Root-Bridge führt.</p> <p>Übernimmt das Gerät die Rolle der Root-Bridge, zeigt das Feld den Wert 0.</p>
Anzahl Topologie-änderungen	<p>Zeigt, wie oft das Gerät seit dem Start einen Geräte-Port durch Spanning Tree in den Zustand <code>Forwarding</code> gesetzt hat.</p>
Zeit seit letzter Änderung	<p>Zeigt die Zeit seit der letzten Topologieänderung.</p> <p>Mögliche Werte:</p> <ul style="list-style-type: none"> ▶ <Tage, Stunden:Minuten:Sekunden>
Root-Pfadkosten	<p>Zeigt die Pfadkosten für den Pfad, der vom Root-Port des Geräts zur Root-Bridge des Schicht-2-Netzes führt.</p> <p>Mögliche Werte:</p> <ul style="list-style-type: none"> ▶ 0..200000000 <p>Wenn der Wert 0 festgelegt ist, übernimmt das Gerät die Rolle der Root-Bridge.</p>

■ Schaltflächen

	Beendet die Sitzung und trennt die Verbindung zum Gerät.
	Startet das Gerät neu.

476	Zeigt die Zeit in Sekunden, nach der das Gerät bei Inaktivität des Benutzers die Sitzung automatisch beendet.
Laden	Lädt die Anzeige der Seite in Ihrem Web-Browser neu.
Schreiben	Überträgt die Änderungen in den flüchtigen Speicher des Gerätes. Um die Änderungen im nicht-flüchtigen lokalen Speicher des Gerätes zu speichern, gehen Sie wie folgt vor: <ul style="list-style-type: none"> <input type="checkbox"/> Öffnen Sie den Dialog Grundeinstellungen > Laden/Speichern. <input type="checkbox"/> Klicken Sie „Speichern“ im Rahmen „Laden/Speichern“ neben „Aktuelle Konfiguration speichern“.
Hilfe	Öffnet die Online-Hilfe.

11.4.10 Switching > L2-Redundanz > Spanning Tree > Port

Dieser Dialog bietet Ihnen die Möglichkeit, an den Geräte-Ports die Spanning-Tree-Funktion ein-/auszuschalten, Edge-Ports festzulegen sowie die Einstellungen für verschiedene Schutzfunktionen festzulegen.



■ Tabelle

Parameter	Bedeutung
Port	Zeigt die Nummer des Geräte-Ports.
Stp	Schaltet die Spanning-Tree-Funktion auf dem Geräte-Port ein/aus. Mögliche Werte: <ul style="list-style-type: none"> ▶ On (Voreinstellung) ▶ Off Ist die Spanning-Tree-Funktion im Gerät eingeschaltet und auf dem Geräte-Port ausgeschaltet, sendet der Port keine STP-BPDUs und verwirft empfangene STP-BPDUs.
Port-Priorität	Legt die Priorität des Geräte-Ports fest. Mögliche Werte: <ul style="list-style-type: none"> ▶ 16..240 in 16er-Schritten (Voreinstellung: 128) Der Wert repräsentiert die ersten 4 Bits der Port-ID.

Parameter	Bedeutung
Port-Pfadkosten	<p>Legt die RSTP-Port-Pfadkosten zur Bevorzugung redundanter Pfade fest (entspricht einem Beitrag dieses Ports zu den globalen Root-Pfadkosten). Mögliche Werte:</p> <p>Mögliche Werte:</p> <ul style="list-style-type: none"> ▶ 0..200000000 <p>Wenn der Wert 0 festgelegt ist, ermittelt das Gerät automatisch die Pfadkosten abhängig von der Datenrate.</p>
Port Status	<p>Zeigt den Vermittlungsstatus des Geräte-Ports.</p> <p>Mögliche Werte:</p> <ul style="list-style-type: none"> ▶ discarding Der Geräte-Port ist blockiert und leitet ausschließlich STP-BPDUs weiter. ▶ learning Der Geräte-Port ist blockiert, lernt jedoch die MAC-Adressen empfangener Datenpakete. ▶ forwarding Der Geräte-Port leitet Datenpakete weiter. ▶ disabled Die Spanning-Tree-Funktion ist auf dem Geräte-Port ausgeschaltet. Der Geräte-Port leitet STP-BPDUs weiter. ▶ disconnected Es ist kein Kabel angeschlossen.
Port Rolle	<p>Zeigt die gegenwärtige Rolle des Ports im CIST.</p> <p>Mögliche Werte:</p> <ul style="list-style-type: none"> ▶ root Port mit dem günstigsten Pfad zur Root-Bridge. ▶ alternate Port mit dem alternativen Pfad zur Root-Bridge (gegenwärtig unterbrochen). ▶ designated Port zur von der Root-Bridge abgewandten Seite des Baums. ▶ backup Port empfängt STP-BPDUs des eigenen Geräts. ▶ master Port mit dem günstigsten Pfad zum CIST. Der Port ist CIST-Root-Port der CIST-Regional-Root. Der Port ist in einer MST-Region einzigartig. ▶ disabled Der Port ist inaktiv. Siehe Dialog Grundeinstellungen Port, Konfiguration Registerkarte.
Oper Edge Port	<p>Zeigt, ob am Geräte-Port ein Endgerät oder eine STP-Bridge angeschlossen ist.</p> <p>Mögliche Werte:</p> <ul style="list-style-type: none"> ▶ enable Am Geräte-Port ist ein Endgerät angeschlossen. Der Geräte-Port empfängt keine STP-BPDUs. ▶ disable Am Geräte-Port ist eine STP-Bridge angeschlossen. Der Geräte-Port empfängt STP-BPDUs.

Parameter	Bedeutung
Admin Edge Port	<p>Legt fest, ob am Geräte-Port ein Endgerät angeschlossen ist.</p> <p>Mögliche Werte:</p> <ul style="list-style-type: none"> ▶ unmarked (Voreinstellung) Am Geräte-Port ist eine STP-Bridge angeschlossen. Nach Aufbau der Verbindung wechselt der Geräte-Port in den Status <code>learning</code>, bevor er ggf. in den Status <code>forwarding</code> wechselt. ▶ marked Am Geräte-Port ist ein Endgerät angeschlossen. <ul style="list-style-type: none"> – Nach Aufbau der Verbindung wechselt der Geräte-Port in den Status <code>forwarding</code>, bevor er ggf. in den Status <code>learning</code> wechselt. – Empfängt der Geräte-Port eine STP-BPDU, deaktiviert das Gerät den Port, falls im Dialog <code>Switching > L2-Redundanz > Spanning Tree > Global</code> die BPDU-Guard-Funktion eingeschaltet ist.
Auto Edge Port	<p>Aktiviert/deaktiviert die automatische Erkennung, ob an den Port ein Endgerät angeschlossen ist. Diese Einstellung ist ausschließlich dann wirksam, wenn das Kontrollkästchen im Feld „Admin Edge Port“ unmarkiert ist.</p> <p>Mögliche Werte:</p> <ul style="list-style-type: none"> ▶ marked (Voreinstellung) Nach Aufbau der Verbindung setzt das Gerät den Port nach $1,5 \times$ „Hello Time [s]“ in den Zustand <code>forwarding</code> (in der Voreinstellung $1,5 \times 2$ s), falls der Port währenddessen keine STP-BPDU empfängt. ▶ unmarked Nach Aufbau der Verbindung setzt das Gerät den Port nach „Max Age“ in den Zustand <code>forwarding</code> (in der Voreinstellung 20 s).

■ Schaltflächen

	Beendet die Sitzung und trennt die Verbindung zum Gerät.
	Alphanumerische ASCII-Zeichenfolge mit 0..64 Zeichen
	Zeigt die Zeit in Sekunden, nach der das Gerät bei Inaktivität des Benutzers die Sitzung automatisch beendet.
Laden	Lädt die Anzeige der Seite in Ihrem Web-Browser neu.
Schreiben	<p>Überträgt die Änderungen in den flüchtigen Speicher des Gerätes. Um die Änderungen im nicht-flüchtigen lokalen Speicher des Gerätes zu speichern, gehen Sie wie folgt vor:</p> <ul style="list-style-type: none"> <input type="checkbox"/> Öffnen Sie den Dialog <code>Grundeinstellungen > Laden/Speichern</code>. <input type="checkbox"/> Klicken Sie „Speichern“ im Rahmen „Laden/Speichern“ neben „Aktuelle Konfiguration speichern“.

Hilfe Öffnet die Online-Hilfe.

11.5 Secure Remote Access

11.5.1 Secure Remote Access > SiteManager GECKO

Der SiteManager GECKO ist ein Hirschmann-Client zur Unterstützung des sicheren Fernzugriffs. Er hilft beim Aufbau einer sicheren Verbindung von bis zu 10 an den SiteManager GECKO angebotenen Geräten.

Der Dialog bietet Ihnen folgende Möglichkeiten:

- ▶ Grundlegende Einstellungen für den SiteManager GECKO festlegen.
- ▶ Den Verbindungsstatus zum GateManager Server überwachen und die Softwareversion des Clients anzeigen.
- ▶ Den SiteManager GECKO Client auf den Lieferzustand zurücksetzen.
- ▶ Eine Log-Datei auf dem PC speichern.

■ Konfiguration

Beschreibung	Bedeutung
Funktion	<p>Bei eingeschalteter Funktion baut das Gerät eine Verbindung zum GateManager auf.</p> <p>Mögliche Werte:</p> <ul style="list-style-type: none"> ▶ „An“ Der SiteManager GECKO baut mit den festgelegten Werten eine dauerhafte Verbindung zum GateManager auf. ▶ „Aus“ (Voreinstellung) Keine Verbindung zum GateManager.
GateManager Server	<p>Legt die IPv4-Adresse des GateManager Servers fest.</p> <p>Mögliche Werte:</p> <ul style="list-style-type: none"> ▶ Gültige IPv4-Adresse <p>Verwenden Sie einen Webproxy oder ein Gateway, falls die festgelegte Adresse im erreichbaren Subnetz (Netzmaske) unerreichbar ist.</p> <p>Das Gateway legen Sie fest im Dialog Grundeinstellungen > Netz, Rahmen „IP-Parameter“, Feld „Gateway-Adresse“.</p> <p>Alternativ legen Sie das Gateway über HiDiscovery oder über einen DHCP-Server fest.</p> <p>Daten für den Webproxy legen Sie in den Feldern „Webproxy Address“, „Webproxy Account“ und „Webproxy Password“ fest.</p>
GateManager Token	<p>Legt das Domänen-Token für die Verbindung zum GateManager fest.</p> <p>Mögliche Werte:</p> <ul style="list-style-type: none"> ▶ alphanumerische ASCII-Zeichenfolge
Name	<p>Legt die Bezeichnung für den Eintrag fest. Geben Sie einen Namen ein, der den SiteManager GECKO beschreibt.</p> <p>Mögliche Werte:</p> <ul style="list-style-type: none"> ▶ alphanumerische ASCII-Zeichenfolge
Webproxy Address	<p>Legt die IPv4-Adresse für den Webproxy fest.</p> <p>Mögliche Werte:</p> <ul style="list-style-type: none"> ▶ [leer] Kein Webproxy. ▶ Gültige IPv4-Adresse <p>Verwenden Sie ein Gateway, falls sich Webproxy und GECKO in unterschiedlichen Subnetzen befinden.</p>
Webproxy Account	<p>Legt den Benutzernamen fest, mit dem sich der Benutzer beim Webproxy authentifiziert.</p>
Webproxy Password	<p>Legt das Passwort fest, mit dem sich der Benutzer beim Webproxy authentifiziert.</p>

Tab. 8: Konfiguration

■ Status

Beschreibung	Bedeutung
Status	<p>Zeigt den Status der Verbindung zwischen SiteManager GECKO und GateManager.</p> <p>Mögliche Werte:</p> <ul style="list-style-type: none"> ▶ <i>Starte</i> Das Gerät startet den Verbindungsaufbau. Der SiteManager GECKO überprüft die IP-Adresse des GateManagers. ▶ <i>Nicht verbunden</i> Verbindung zwischen SiteManager GECKO und GateManager inaktiv. ▶ <i>Verbinde mit a.b.c.d</i> Das Gerät baut die Verbindung zwischen SiteManager GECKO und GateManager auf. Falls Sie einen Webproxy verwenden, baut das Gerät die Verbindung zum GateManager über den Webproxy auf. ▶ <i>Verbindung mit a.b.c.d</i> Verbindung zwischen SiteManager GECKO und GateManager aktiv.

Tab. 9: *Status*

■ SiteManager GECKO

Beschreibung	Bedeutung
Laufende Version	<p>Zeigt die Versionsnummer des SiteManager GECKO, die das Gerät derzeit ausführt.</p> <p>Der GateManager bietet Ihnen die Möglichkeit, ausschließlich den SiteManager GECKO zu aktualisieren.</p> <p>Der Rahmen "Software-Update" im Dialog Grundeinstellungen > Software bietet Ihnen die Möglichkeit, die Geräte-Software des GECKO und den SiteManager GECKO gleichzeitig zu aktualisieren.</p> <p>Siehe „Software aktualisieren“ auf Seite 37.</p>

Tab. 10: *SiteManager GECKO*

■ Schaltflächen

Zurücksetzen	<p>SiteManager GECKO auf Auslieferungszustand zurücksetzen</p> <p>Setzt den SiteManager GECKO auf den Lieferzustand zurück. Das Gerät entfernt die über den GateManager installierten Updates. Die GECKO-Geräte-Software bleibt erhalten.</p> <p>Die GECKO-Geräte-Software setzen Sie zurück über die Schaltfläche "Auf Lieferzustandzurücksetzen" im Dialog Grundeinstellungen > Laden/Speichern.</p>
Speichern	<p>SiteManager GECKO Log</p> <p>Speichert die Log-Datei "sitemanager_syslog0.txt" auf ihrem PC. Die Datei enthält detaillierte Verbindungs- und Laufzeitinformationen</p>
Laden	Lädt die Anzeige der Seite in Ihrem Web-Browser neu.
Schreiben	<p>Überträgt die Änderungen in den flüchtigen Speicher des Gerätes. Um die Änderungen im nicht-flüchtigen lokalen Speicher des Gerätes zu speichern, gehen Sie wie folgt vor:</p> <ul style="list-style-type: none"> <input type="checkbox"/> Öffnen Sie den Dialog Grundeinstellungen > Laden/Speichern. <input type="checkbox"/> Klicken Sie „Speichern“ im Rahmen „Laden/Speichern“ neben „Aktuelle Konfiguration speichern“.
Hilfe	Öffnet die Online-Hilfe.

11.5.2 Secure Remote Access > About

Das Gerät bietet Ihnen mit dem SiteManager GECKO ein Werkzeug zur Unterstützung beim sicheren Fernzugriff (Secure Remote Access).

Der sichere Fernzugriff bietet Ihnen folgende Möglichkeiten:

- ▶ Geografisch voneinander getrennt liegende Geräte verbinden.
- ▶ Fernprogrammierung von industriellen Komponenten mit den vertrauten Programmierwerkzeugen.
- ▶ Fernsteuerung und Fernüberwachung von industriellen Anlagen mit Hilfe Ihres PCs, iPhones oder Android-Geräts.
- ▶ Betrieb der Maschinen ohne physischen Zugang zu dem Maschinennetz.
- ▶ Einsatz von Sicherheitsmechanismen auf normalerweise unsicheren Geräten (Tablets oder Smartphones).
- ▶ Erstellung von Accounts für Maschinenbediener mit getrennten Zugängen zu spezifischen Geräten.

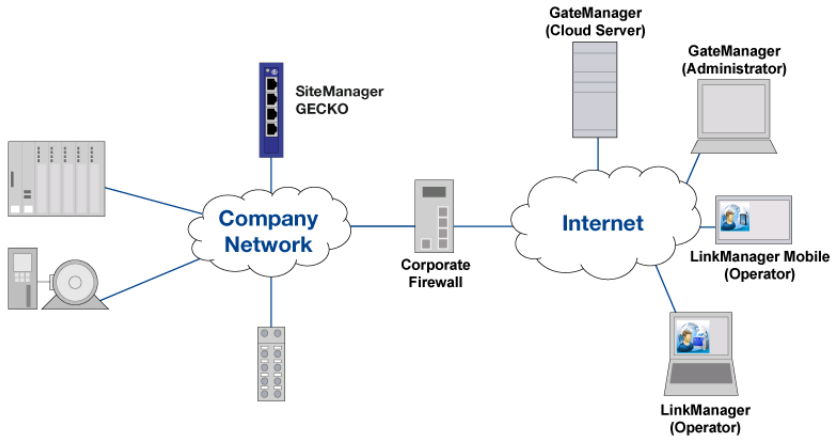

11.6 Diagnose

Die Dialoge dieses Menüs zeigen Informationen zu Zuständen und Ereignissen an, die das Gerät protokolliert hat. Im Service-Fall helfen diese Informationen unserem Support bei der Diagnose.

11.6.1 Diagnose >Alarme (Traps)



■ Alarme (Traps)

Parameter	Bedeutung
Function	<p>Legt fest, ob das Gerät einen SNMP-Trap sendet, wenn es eine Änderung bei den überwachten Funktionen erkennt.</p> <p>Mögliche Werte:</p> <ul style="list-style-type: none"> ▶ On Das Gerät sendet einen SNMP-Trap. ▶ Off (Voreinstellung) Das Gerät sendet keinen SNMP-Trap. <p>Voraussetzung für das Senden von SNMP-Traps ist, dass Sie die Linküberwachung im Dialog <code>Basic settings > Port > Configuration</code> einschalten und mindestens 1 SNMP-Manager (Zieladresse) festlegen.</p>
Link Up/Down	An einem Port des Gerätes wurde eine Verbindung mit einem dort angeschlossenen Gerät hergestellt/unterbrochen.
Authentifizierung	Das Gerät hat einen unerlaubten Zugriff zurückgewiesen. Siehe „Gerätesicherheit > SNMP“ auf Seite 89.
Spanning Tree	Die Topologie des Rapid Spanning Tree hat sich geändert.
LLDP	Wird gesendet, wenn sich ein Eintrag in der Tabelle Topologie-Erkennung ändert.

■ Zieladressen

Parameter	Bedeutung
IP-Adresse	Legt die IP-Adresse des SNMP-Managers fest. Mögliche Werte: ▶ Gültige IPv4-Adresse
Trap Community	Legt den Namen der Trap Community fest, den das Gerät verwendet, um sich als Quelle des Traps zu identifizieren. Mögliche Werte: ▶ public (Voreinstellung) ▶ Alphanumerische ASCII-Zeichenfolge mit 0..64 Zeichen

■ Schaltflächen

	Beendet die Sitzung und trennt die Verbindung zum Gerät.
	Alphanumerische ASCII-Zeichenfolge mit 0..64 Zeichen
	Zeigt die Zeit in Sekunden, nach der das Gerät bei Inaktivität des Benutzers die Sitzung automatisch beendet.
Laden	Lädt die Anzeige der Seite in Ihrem Web-Browser neu.
Schreiben	Überträgt die Änderungen in den flüchtigen Speicher des Gerätes. Um die Änderungen im nicht-flüchtigen lokalen Speicher des Gerätes zu speichern, gehen Sie wie folgt vor: <input type="checkbox"/> Öffnen Sie den Dialog Grundeinstellungen > Laden/Speichern . <input type="checkbox"/> Klicken Sie „Speichern“ im Rahmen „Laden/Speichern“ neben „Aktuelle Konfiguration speichern“.
Hilfe	Öffnet die Online-Hilfe.

11.6.2 Diagnose > LLDP

Das Gerät bietet Ihnen die Möglichkeit, Informationen über benachbarte Geräte zu sammeln. Dazu nutzt das Gerät das Link Layer Discovery Protocol (LLDP). Mit diesen Informationen ist eine Netzmanagement-Station in der Lage, die Struktur Ihres Netzes darzustellen.

Geräte in Netzen versenden Mitteilungen in Form von Paketen, welche auch unter dem Namen „LLDPDU“ (LLDP-Dateneinheit) bekannt sind. Die über LLDPDUs versendeten und empfangenen Daten sind aus vielen Gründen nützlich. So erkennt das Gerät etwa, bei welchen Geräten innerhalb des Netzes es sich um Nachbarn handelt und über welche Ports diese miteinander verbunden sind.

Dieser Dialog bietet Ihnen die Möglichkeit, das Netz darzustellen und die angeschlossenen Geräte mitsamt ihren Funktionsmerkmalen zu ermitteln.

■ LLDP

Parameter	Bedeutung
Function	Bei eingeschalteter Funktion ist die Topologie-Erkennung per LLDP auf dem Gerät aktiviert. Mögliche Werte: ▶ An (Voreinstellung) ▶ Aus

■ Topologie-Erkennung

Dieser Dialog zeigt die gesammelten LLDP-Informationen zu den Nachbargeräten an. Mit diesen Informationen ist eine Netzmanagement-Station in der Lage, die Struktur Ihres Netzes darzustellen.

Wenn an einem Geräte-Port sowohl Geräte mit als auch ohne aktive Topologie-Erkennungs-Funktion angeschlossen sind, dann blendet die Topologie-Tabelle die Geräte ohne aktive Topologie-Erkennung aus.

Wenn ausschließlich Geräte ohne aktive Topologie-Erkennung an einem Geräte-Port angeschlossen sind, dann enthält die Tabelle stellvertretend für alle Geräte eine Zeile für diesen Port. Diese Zeile enthält die Anzahl der angeschlossenen Geräte.

Die FDB-Adresstabelle enthält MAC-Adressen von Geräten, die die Topologie-Tabelle aus Gründen der Übersicht ausblendet.

Wenn Sie an einen Port mehrere Geräte anschließen (zum Beispiel über einen Hub), zeigt die Tabelle für jedes angeschlossene Gerät je eine Zeile.

Parameter	Bedeutung
Port	Zeigt die Nummer des Geräte-Ports.
Nachbar-Bezeichner	Zeigt die Chassis-ID des Nachbargeräts. Dies kann zum Beispiel die Basis-MAC-Adresse des Nachbargeräts sein.
Nachbar-IP-Adresse	Zeigt die IP-Adresse, mit der die Management-Funktionen des Nachbargerätes erreichbar sind.
Nachbar-Port-Beschreibung	Zeigt eine Beschreibung für den Geräte-Port des Nachbargerätes.
Nachbar-Systemname	Zeigt den Gerätenamen des Nachbargeräts.
Nachbar-Systembeschreibung	Zeigt eine Beschreibung für das Nachbargerät.

■ Schaltflächen



Beendet die Sitzung und trennt die Verbindung zum Gerät.



Alphanumerische ASCII-Zeichenfolge mit 0..64 Zeichen



Zeigt die Zeit in Sekunden, nach der das Gerät bei Inaktivität des Benutzers die Sitzung automatisch beendet.

Laden	Lädt die Anzeige der Seite in Ihrem Web-Browser neu.
Schreiben	Überträgt die Änderungen in den flüchtigen Speicher des Gerätes. Um die Änderungen im nicht-flüchtigen lokalen Speicher des Gerätes zu speichern, gehen Sie wie folgt vor: <ul style="list-style-type: none"> <input type="checkbox"/> Öffnen Sie den Dialog <i>Grundeinstellungen > Laden/Speichern</i>. <input type="checkbox"/> Klicken Sie „Speichern“ im Rahmen „Laden/Speichern“ neben „Aktuelle Konfiguration speichern“.
Hilfe	Öffnet die Online-Hilfe.

11.6.3 Diagnose > System Log

■ System Information

Dieser Dialog zeigt den gegenwärtigen Betriebszustand einzelner Komponenten im Gerät.

Der Dialog bietet Ihnen die Möglichkeit, die Seite im HTML-Format auf Ihrem PC zu speichern.

■ System Log



Das Gerät protokolliert wichtige geräteinterne Ereignisse in einer Log-Datei (System Log).

Dieser Dialog zeigt die Log-Datei (System Log) an. Der Dialog bietet Ihnen die Möglichkeit, die Log-Datei im HTML-Format auf Ihrem PC zu speichern.

Die Log-Datei bleibt bis zu einem Neustart des Geräts erhalten. Nach dem Neustart erstellt das Gerät die Datei neu.

Um die protokollierten Ereignisse aus der Log-Datei zu entfernen, klicken Sie die Schaltfläche „Logdatei löschen“.

■ Schaltflächen

	Beendet die Sitzung und trennt die Verbindung zum Gerät.
	Alphanumerische ASCII-Zeichenfolge mit 0..64 Zeichen
<input type="text" value="476"/>	Zeigt die Zeit in Sekunden, nach der das Gerät bei Inaktivität des Benutzers die Sitzung automatisch beendet.
Laden	Lädt die Anzeige der Seite in Ihrem Web-Browser neu.
Speichern	Öffnet den Dialog „Speichern“. Der Dialog bietet Ihnen die Möglichkeit, die Log-Datei im HTML-Format auf Ihrem PC zu speichern.
Logdatei löschen	Entfernt die protokollierten Einträge aus der Log-Datei.
Hilfe	Öffnet die Online-Hilfe.

11.6.4 Diagnose > Syslog

Das Gerät ermöglicht Ihnen, ausgewählte Ereignisse abhängig vom Schweregrad des Ereignisses an unterschiedliche Syslog-Server zu melden. In diesem Dialog legen Sie die Einstellungen dafür fest und verwalten bis zu 2 Syslog-Server.

■ Syslog

Parameter	Bedeutung
Function	Schaltet das Senden von Ereignissen an die Syslog-Server ein/aus. Mögliche Werte: <ul style="list-style-type: none"> ▶ An Das Senden von Ereignissen ist eingeschaltet. Das Gerät sendet die in der Tabelle festgelegten Ereignisse zum jeweils festgelegten Syslog-Server. ▶ Aus (Voreinstellung) Das Senden von Ereignissen ist ausgeschaltet.

■ Tabelle

Parameter	Bedeutung
Index	<p>Zeigt die Index-Nummer, auf die sich der Tabelleneintrag bezieht. Wenn Sie einen Tabelleneintrag löschen, bleibt eine Lücke in der Nummerierung. Wenn Sie einen neuen Tabelleneintrag erzeugen, schließt das Gerät die 1. Lücke.</p> <p>Mögliche Werte:</p> <ul style="list-style-type: none"> ▶ 1..2
IP-Adresse	<p>Legt die IP-Adresse des Syslog-Servers fest.</p> <p>Mögliche Werte:</p> <ul style="list-style-type: none"> ▶ Gültige IPv4-Adresse (Voreinstellung: 0.0.0.0)
Ziel UDP Port	<p>Legt den TCP- oder UDP-Port an, auf dem der Syslog-Server die Protokolleinträge erwartet.</p> <p>Mögliche Werte:</p> <ul style="list-style-type: none"> ▶ 1..65535 (Voreinstellung: 514)
Transport Typ	<p>Zeigt den Transporttyp fest, den das Gerät verwendet, um Ereignisse an den Syslog-Server zuzusenden.</p>
Min. severity	<p>Legt den Mindest-Schweregrad der Ereignisse fest. Das Gerät sendet einen Log-Eintrag für Ereignisse mit diesem Schweregrad und mit dringlicheren Schweregraden an den Syslog-Server.</p> <p>Mögliche Werte:</p> <ul style="list-style-type: none"> ▶ emergency ▶ alert ▶ critical ▶ error ▶ warning (Voreinstellung) ▶ notice ▶ informational ▶ debug
Typ	<p>Legt den Typ des Log-Eintrags fest, den das Gerät übermittelt.</p>
Aktiv	<p>Aktiviert bzw. deaktiviert die Übermittlung der Ereignisse zum Syslog-Server:</p> <ul style="list-style-type: none"> ▶ marked Das Gerät sendet Ereignisse zum Syslog-Server. ▶ unmarked (Voreinstellung) Die Übermittlung der Ereignisse zum Syslog-Server ist deaktiviert.

11.7 Erweitert

11.7.1 Erweitert > Industrieprotokolle > PROFINET

Dieser Dialog bietet Ihnen die Möglichkeit, das PROFINET-Protokoll im Gerät zu konfigurieren, das zusammen mit PROFINET-Controllern und PROFINET-Geräten verwendet wird. Die PROFINET-Funktion des Geräts basiert auf dem PROFINET-Stack V2.2 von Siemens für gängige Ethernet-Controller. Das PROFINET-Protokoll im Gerät entspricht Class B für Antworten in Echtzeit gemäß IEC 61158.

Die folgenden Funktionen wirken sich direkt auf die PROFINET-Funktion aus. Stellen Sie sicher, dass die Parameter wie in der folgenden Tabelle beschrieben eingestellt sind:

Parameter	Bedeutung
PROFINET	Dialog Erweitert > Industrieprotokolle > PROFINET Rahmen „PROFINET“ Function=An Rahmen „Konfiguration“ Station Name = <leer>
Netz	Dialog Grundeinstellungen > Netz Rahmen „Management-Schnittstelle“ Optionsfeld „Zuweisung IP-Adresse“ = Lokal Rahmen „IP-Parameter“ IP-Adresse = 0.0.0.0 Netzmaske = 0.0.0.0 Gateway-Adresse = 0.0.0.0 Rahmen „HiDiscovery-Protokoll“ Schreibrecht = Aus

Parameter	Bedeutung
VLAN	Dialog <code>Switching > Global</code> Rahmen „Konfiguration“ Kontrollkästchen „VLAN Unaware Mode“ = <code>marked</code>
LLDP	Dialog <code>Diagnose > LLDP > Konfiguration</code> Rahmen „Konfiguration“ Sende-Intervall [s] = 5 Sende-Verzögerung [s] = 1
DHCP	Dialog <code>Grundeinstellungen > Netz</code> Rahmen „Management-Schnittstelle“ Optionsfeld „DHCP“ = <code>unmarked</code>

■ PROFINET

Wenn Sie den Betriebsstatus der Funktion ändern, ist ein Neustart erforderlich. Um das Gerät neu zu starten, führen Sie die folgenden Arbeitsschritte durch:

- Öffnen Sie den Dialog `Grundeinstellungen > Software`.
- Klicken Sie die Schaltfläche „Neustart“.

Parameter	Bedeutung
Function	Schaltet die PROFINET-Funktion im Gerät ein/aus. Mögliche Werte: <ul style="list-style-type: none"> ▶ <code>An</code> Die PROFINET-Funktion ist eingeschaltet. ▶ <code>Aus (Voreinstellung)</code> Die PROFINET-Funktion ist ausgeschaltet.
GSDML-Datei runterladen	Kopiert die GSDML-Datei auf Ihren PC.



■ DCP Mode

Wenn Sie die PROFINET-Funktion aktivieren, zeigt das Gerät die folgenden Werte an.

Parameter	Bedeutung
Port	Zeigt die Nummer des Ports.

Parameter	Bedeutung
DCP Mode	<p>Legt die Richtung des Datenstroms für DCP-Pakete auf dem zu überwachenden Port fest.</p> <p>Die speicherprogrammierbare Steuerung (SPS) erkennt PROFInet-Geräte über das Discovery-and-Configuration-Protokoll (DCP).</p> <p>Die DCP-Identifizierungsanfrage-Pakete sind multicast, die Antworten der Agenten sind unicast. Unabhängig von den Einstellungen leitet das Gerät die empfangenen DCP-Pakete an andere Geräte-Ports mit der Einstellung egress oder both weiter.</p> <p>Mögliche Werte:</p> <ul style="list-style-type: none"> ▶ kein Mode Der Agent antwortet auf keine Pakete, die auf diesem Port empfangen wurden. Der Port leitet keine Pakete weiter, die auf anderen Ports empfangen wurden. ▶ Ingress Der Agent antwortet auf Pakete, die auf diesem Port empfangen wurden. Der Port leitet keine Pakete weiter, die auf anderen Ports empfangen wurden. ▶ Egress Der Agent antwortet auf keine Pakete, die auf diesem Port empfangen wurden. Der Port leitet Pakete weiter, die auf anderen Ports empfangen wurden. ▶ beide (Voreinstellung) Der Agent antwortet auf Pakete, die auf diesem Port empfangen wurden. Der Port leitet Pakete weiter, die auf anderen Ports empfangen wurden.

11.7.2 Schaltflächen

	Beendet die Sitzung und trennt die Verbindung zum Gerät.
	Alphanumerische ASCII-Zeichenfolge mit 0..64 Zeichen
	Zeigt die Zeit in Sekunden, nach der das Gerät bei Inaktivität des Benutzers die Sitzung automatisch beendet.
Laden	Lädt die Anzeige der Seite in Ihrem Web-Browser neu.

Schreiben	<p>Überträgt die Änderungen in den flüchtigen Speicher des Gerätes. Um die Änderungen im nicht-flüchtigen lokalen Speicher des Gerätes zu speichern, gehen Sie wie folgt vor:</p> <ul style="list-style-type: none"><input type="checkbox"/> Öffnen Sie den Dialog <code>Grundeinstellungen > Laden/Speichern</code>.<input type="checkbox"/> Klicken Sie „Speichern“ im Rahmen „Laden/Speichern“ neben „Aktuelle Konfiguration speichern“.
Hilfe	Öffnet die Online-Hilfe.

A Anhang

A.1 Technische Daten

Switching	
Größe MAC-Adresstabelle (inkl. statische Filter)	1.024
Max. Anzahl statisch konfigurierter MAC- Adressfilter	100
MTU (Max. Länge überlanger Pakete)	1.522 Bytes
Latenz, abhängig von der Port-Datenrate 100 Mbit/s	min.7 μ s max. 9 μ s
Max. Anzahl statischer Adresseinträge	100
Max. Anzahl dynamischer Unicast-Einträge	910
Anzahl Warteschlangen	4 Queues
Einstellbare Port-Prioritäten	0 ... 7

A.2 Zugrundeliegende technische Normen

ANSI/TIA-1057	Link Layer Discovery Protocol for Media Endpoint Devices, April 2006
IEEE 802.1AB	Topology Discovery (LLDP)
IEEE 802.1D-1998, IEEE 802.1D-2004	Media access control (MAC) bridges (includes IEEE 802.1p Priority and Dynamic Multicast Filtering, GARP, GMRP)
IEEE 802.1Q-1998	Virtual Bridged Local Area Networks (VLAN Tagging, Port Based VLANs, GVRP)
IEEE 802.1Q-2005	Spanning Tree (STP), Rapid Spanning Tree (RSTP), Multiple Spanning Tree (MSTP)
IEEE 802.3-2002	Ethernet
IEEE 802.3x	Flow Control

A.3 Liste der RFCs

RFC 768	UDP
RFC 783	TFTP
RFC 791	IP
RFC 792	ICMP
RFC 793	TCP
RFC 826	ARP
RFC 951	BOOTP
RFC 1157	SNMPv1
RFC 1155	SMIv1
RFC 1212	Concise MIB Definitions
RFC 1213	MIB2
RFC 1493	Dot1d
RFC 1542	BOOTP-Extensions
RFC 1643	Ethernet-like -MIB
RFC 1757	RMON
RFC 1867	Form-Based File Upload in HTML
RFC 1901	Community based SNMP v2
RFC 1905	Protocol Operations for SNMP v2
RFC 1906	Transport Mappings for SNMP v2
RFC 1907	Management Information Base for SNMP v2
RFC 1908	Coexistence between SNMP v1 and SNMP v2
RFC 1945	HTTP/1.0
RFC 2068	HTTP/1.1
RFC 2131	DHCP
RFC 2132	DHCP-Options
RFC 2233	The Interfaces Group MIB using SMI v2
RFC 2246	The TLS Protocol, Version 1.0
RFC 2271	SNMP Framework MIB
RFC 2346	AES Ciphersuites for Transport Layer Security
RFC 2365	Administratively Scoped Boundaries
RFC 2474	Definition of the Differentiated Services Field (DS Field) in the IPv4 and IPv6 Headers
RFC 2475	An Architecture for Differentiated Service
RFC 2570	Introduction to SNMP v3
RFC 2571	Architecture for Describing SNMP Management Frameworks
RFC 2572	Message Processing and Dispatching for SNMP
RFC 2573	SNMP v3 Applications
RFC 2574	User Based Security Model for SNMP v3
RFC 2575	View Based Access Control Model for SNMP

RFC 2576	Coexistence between SNMP v1, v2 & v3
RFC 2578	SMIv2
RFC 2579	Textual Conventions for SMI v2
RFC 2580	Conformance statements for SMI v2
RFC 2674	Dot1p/Q
RFC 2818	HTTP over TLS
RFC 2851	Internet Addresses MIB
RFC 4188	(Definitions of Managed Objects for Bridges)

A.4 Literaturhinweise

- ▶ „Optische Übertragungstechnik
in industrieller Praxis“
Christoph Wrobel (Hrsg.)
Hüthig Buch Verlag Heidelberg
ISBN 3-7785-2262-0
- ▶ „TCP/IP Illustrated“, Vol. 1
W.R. Stevens
Addison Wesley 1994
ISBN 0-201-63346-9
- ▶ Hirschmann Anwender-Handbuch „Installation“
- ▶ Hirschmann Montageanleitung

A.5 Grundlagen IP-Parameter

A.5.1 IP-Adresse (Version 4)

Die IP-Adressen bestehen aus 4 Bytes. Diese 4 Bytes werden durch einen Punkt getrennt, dezimal dargestellt.

Seit 1992 sind im RFC 1340 5 Klassen von IP-Adressen definiert.

Klasse	Netzadresse	Hostadresse	Adressbereich
A	1 Byte	3 Bytes	0.0.0.0 bis 127.255.255.255
B	2 Bytes	2 Bytes	128.0.0.0 bis 191.255.255.255
C	3 Bytes	1 Byte	192.0.0.0 bis 223.255.255.255
D			224.0.0.0 bis 239.255.255.255
E			240.0.0.0 bis 255.255.255.255

Tab. 11: IP-Adressklassen

Das erste Byte einer IP-Adresse ist die Netzadresse. Der Regulierungsausschuss für die weltweite Zuweisung von Netzadressen ist IANA („Internet Assigned Numbers Authority“). Falls Sie einen IP-Adressenblock benötigen, wenden Sie sich an Ihren Internet Service Provider (ISP). Ihr ISP wendet sich an seine lokale übergeordnete Organisation, um einen IP-Adressenblock zu reservieren:

- ▶ APNIC (Asia Pacific Network Information Center) – Asien/Pazifik
- ▶ ARIN (American Registry for Internet Numbers) – Amerika und Sub-sahara-Afrika
- ▶ LACNIC (Regional Latin-American and Caribbean IP Address Registry) – Lateinamerika und weitere Karibik-Inseln
- ▶ RIPE NCC (Réseaux IP Européens) – Europa und umliegende Regionen



Abb. 4: Bitdarstellung der IP-Adresse

Ist das erste Oktett einer IP-Adresse eine Null, d. h. kleiner als 128, gehört sie der Klasse A an.

Ist das erste Bit einer IP-Adresse eine Eins und das zweite Bit eine Null, d. h. das erste Oktett liegt im Bereich von 128 bis 191, dann gehört die IP-Adresse der Klasse B an.

Sind die ersten beiden Bits einer IP-Adresse eine Eins, d. h. das erste Oktett ist größer als 191, dann handelt es sich um eine IP-Adresse der Klasse C.

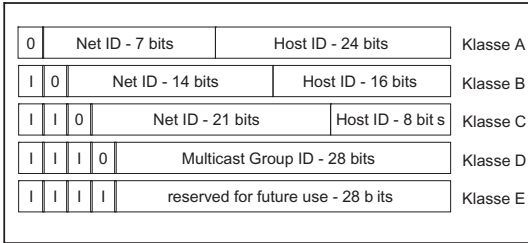
Die Vergabe der Hostadresse (host ID) obliegt dem Netzbetreiber. Der Netzbetreiber allein ist für die Einmaligkeit der IP-Adressen, die er vergibt, verantwortlich.

A.5.2 Netzmaske

Router und Gateways unterteilen große Netze in Subnetze. Die Netzmaske ordnet die IP-Adressen der einzelnen Geräte einem bestimmten Subnetz zu.

Die Einteilung in Subnetze erfolgt über die Netzmaske analog zu der Einteilung der Netzadresse (net id) in die Klassen A bis C.

Setzen Sie die Bits der Hostadresse (host id), die die Maske darstellen, auf Eins. Setzen Sie die restlichen Bits der Hostadresse auf Null (vgl. folgende Beispiele).

Beispiel für eine Subnetzmaske:

Dezimale Darstellung
255.255.192.0

Binäre Darstellung
11111111.11111111.11000000.00000000

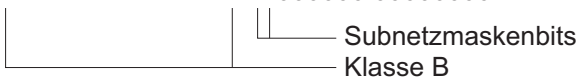

Subnetzmaskenbits
Klasse B

Beispiel für IP-Adressen mit Subnetzzuordnung gemäß der Netzmaske:

Dezimale Darstellung
129.218.65.17

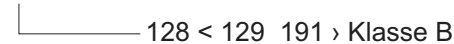

128 < 129 191 > Klasse B

Binäre Darstellung
10000001.11011010.01000001.00010001



Subnetz 1
Netzadresse

Dezimale Darstellung
129.218.129.17

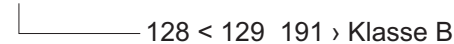

128 < 129 191 > Klasse B

Binäre Darstellung
10000001.11011010.10000001.00010001



Subnetz 2

- Beispiel für die Anwendung der Netzmaske
In einem großen Netz ist es möglich, dass Gateways oder Router den Management-Agenten von ihrer Managementstation trennen. Wie erfolgt in einem solchen Fall die Adressierung?



Abb. 5: Management-Agent durch Router von der Managementstation getrennt

Die Managementstation „Romeo“ möchte Daten an den Management-Agenten „Julia“ schicken. Romeo kennt die IP-Adresse von Julia und weiß, dass der Router „Lorenzo“ den Weg zu Julia kennt.

Also packt Romeo seine Botschaft in einen Umschlag und schreibt als Zieladresse die IP-Adresse von Julia und als Quelladresse seine eigene IP-Adresse darauf.

Diesen Umschlag steckt Romeo in einen weiteren Umschlag mit der MAC-Adresse von Lorenzo als Zieladresse und seiner eigenen MAC-Adresse als Quelladresse. Dieser Vorgang ist vergleichbar mit dem Übergang von der Ebene 3 zur Ebene 2 des ISO/OSI-Basis-Referenzmodells.

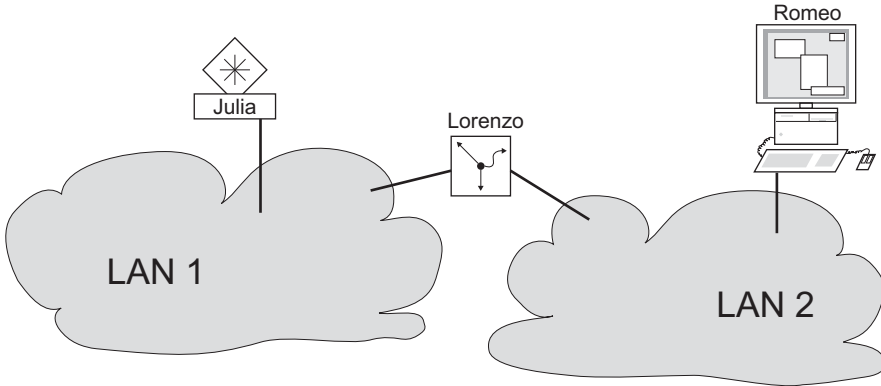
Nun steckt Romeo das gesamte Datenpaket in den Briefkasten, vergleichbar mit dem Übergang von der Ebene 2 zur Ebene 1, dem Senden des Datenpaketes in das Ethernet.

Lorenzo erhält den Brief, entfernt den äußeren Umschlag und erkennt auf dem inneren Umschlag, dass der Brief für Julia bestimmt ist. Er steckt den inneren Umschlag in einen neuen äußeren Umschlag, schaut in seiner Adressliste, der ARP-Tabelle, nach der MAC-Adresse von Julia und schreibt diese auf den äußeren Umschlag als Zieladresse und seine eigene MAC-Adresse als Quelladresse. Das gesamte Datenpaket steckt er anschließend in den Briefkasten.

Julia empfängt den Brief, entfernt den äußeren Umschlag. Übrig bleibt der innere Umschlag mit Romeos IP-Adresse. Das Öffnen des inneren Umschlages und lesen der Botschaft entspricht einer Übergabe an höhere Protokollschichten des ISO/OSI-Schichtenmodells.

Julia möchte eine Antwort an Romeo zurücksenden. Sie steckt ihre Antwort in einen Umschlag mit der IP-Adresse von Romeo als Zieladresse und ihrer eigenen IP-Adresse als Quelladresse. Doch wohin soll Sie die Antwort schicken? Die MAC-Adresse von Romeo hat sie ja nicht erhalten. Die MAC-Adresse von Romeo blieb beim Wechseln des äußeren Umschlages bei Lorenzo zurück.

Julia findet in der MIB unter der Variablen `hmNetGatewayIPAddr` Lorenzo als Vermittler zu Romeo. So steckt sie den Umschlag mit den IP-Adressen in einen weiteren Umschlag mit der MAC-Zieladresse von Lorenzo.

Nun findet der Brief den gleichen Weg über Lorenzo zu Romeo, so wie der Brief von Romeo zu Julia fand.

A.5.3 Classless Inter-Domain Routing

Die Klasse C mit maximal 254 Adressen war zu klein, und die Klasse B mit maximal 65.534 Adressen war für die meisten Anwender zu groß. Hieraus resultierte eine nicht effektive Nutzung der zur Verfügung stehenden Klasse-B-Adressen.

Die Klasse D enthält reservierte Multicast-Adressen. Die Klasse E ist für experimentelle Zwecke vorgesehen. Ein Gateway, das nicht an diesen Experimenten teilnimmt, ignoriert experimentelle Datagramme mit diesen Zieladressen.

Seit 1993 verwendet RFC 1519 Classless Inter-Domain Routing (CIDR) zur Lösung dieses Problems. Das CIDR überwindet diese Klassenschranken und unterstützt klassenlose IP-Adressbereiche.

Mit CIDR geben Sie die Anzahl der Bits an, die den IP-Adressbereich kennzeichnen. Hierzu stellen Sie den IP-Adressbereich in binärer Form dar und zählen die Maskenbits zur Bezeichnung der Netzmaske. Die Maskenbits entsprechen der Anzahl der Bits, die in einem bestimmten IP-Bereich für das Subnetz verwendet werden. Beispiel:

IP-Adresse dezimal	Netzmaske dezimal	IP-Adresse binär
149.218.112.1	255.255.255.128	10010101 11011010 01110000 00000001
149.218.112.127		10010101 11011010 01110000 01111111
		———— 25 Maskenbits ———

CIDR-Schreibweise: 149.218.112.0/25
 |———— Maskenbits

Die Zusammenfassung mehrerer Adressbereiche der Klasse C wird als „Supernetting“ bezeichnet. Mit Supernetting lassen sich Adressbereiche der Klasse B sehr fein untergliedern.

A.6 Grundlagen Dynamic Host Configuration Protocol (DHCP)

Das DHCP (Dynamic Host Configuration Protocol) ist eine Weiterentwicklung von BOOTP und hat dieses abgelöst. DHCP bietet zusätzlich die Konfiguration eines DHCP-Clients über einen Namen anstatt über die MAC-Adresse an.

Dieser Name heißt bei DHCP nach RFC 2131 „Client Identifier“.

Das Gerät verwendet den in der System-Gruppe der MIB II unter sysName eingetragenen Namen als Client Identifier. Diesen Systemnamen können Sie im Dialog *Grundeinstellungen* > *System* im Feld „Gerätename“ eingeben.

Das Gerät übermittelt dem DHCP-Server seinen Systemnamen. Der DHCP-Server verwendet anschließend den Systemnamen für die Zuweisung einer IP-Adresse als Alternative für die MAC-Adresse.

Neben der IP-Adresse überträgt der DHCP-Server

- ▶ die Netzmaske
- ▶ das Standard-Gateway (falls verfügbar)
- ▶ die TFTP-URL der Konfigurationsdatei (falls verfügbar).

Das Gerät wendet die Konfigurationsdaten auf die entsprechenden Parameter an. Wenn der DHCP-Server die IP-Adresse zuweist, speichert das Gerät die Konfigurationsdaten permanent im nicht-flüchtigen Speicher.

Optionen	Bedeutung
1	Subnet Mask
2	Time Offset
3	Router
4	Time server
12	Host Name

Tab. 12: DHCP-Optionen, die das Gerät anfordert

Optionen	Bedeutung
42	NTP server
61	Client Identifier
66	TFTP Server Name
67	Bootfile Name

Tab. 12: DHCP-Optionen, die das Gerät anfordert

Der Vorteil beim Einsatz von DHCP gegenüber BOOTP ist, dass der DHCP-Server die Gültigkeit der Konfigurationsparameter ("Lease") auf eine bestimmte Zeitspanne einschränken kann (sogenannte dynamische Adressvergabe). Rechtzeitig vor Ablauf dieser Zeitspanne ("Lease Duration"), kann der DHCP-Client versuchen, dieses Lease zu erneuern. Alternativ kann er ein neues Lease aushandeln. Der DHCP-Server weist dann eine beliebige freie Adresse zu.

Um dies zu umgehen, bieten DHCP-Server die explizite Konfigurationsmöglichkeit, einem bestimmten Client anhand einer eindeutigen Hardware-ID dieselbe IP-Adresse zuzuordnen (sogenannte statische Adressvergabe).

A.7 Grundlagen Spanning-Tree-Protokoll

Anmerkung: Das Spanning-Tree-Protokoll ist ein Protokoll für MAC-Bridges (Brücken). Daher verwendet die folgende Beschreibung den Begriff Bridge für GECKO.

Lokale Netze werden immer größer. Dies gilt sowohl für die geografische Ausdehnung als auch für die Anzahl der Netzteilnehmer. Deshalb ist der Einsatz mehrerer Bridges vorteilhaft, z. B. um:

- ▶ die Netzlast in Teilbereichen zu verringern,
- ▶ redundante Verbindungen aufzubauen und
- ▶ Entfernungseinschränkungen zu überwinden.

Der Einsatz mehrerer Bridges mit mehrfachen, redundanten Verbindungen zwischen den Teilnetzen kann jedoch zu Schleifen (Loops) und zum Verlust der Kommunikation durch das Netz führen. Als Hilfe, um dies zu verhindern, haben Sie die Möglichkeit, Spanning Tree einzusetzen. Spanning Tree erzielt Schleifenfreiheit durch das gezielte Deaktivieren von redundanten Verbindungen. Das gezielte Wieder-Aktivieren einzelner Verbindungen bei Bedarf ermöglicht die Redundanz.

RSTP ist eine Weiterentwicklung des Spanning-Tree-Protokolls (STP) und ist zu diesem kompatibel. Das STP benötigte bei Betriebsunfähigkeit einer Verbindung oder einer Bridge eine Rekonfigurationszeit von max. 30 s. Dies ist für zeitkritische Anwendungen nicht mehr akzeptabel. RSTP erreicht durchschnittliche Rekonfigurationszeiten von unter einer Sekunde. Wenn Sie RSTP in einer Ringtopologie mit 10 bis 20 Geräten einsetzen, können Sie auch Rekonfigurationszeiten im Millisekundenbereich erreichen.

Anmerkung: RSTP löst eine Layer 2-Netztopologie mit redundanten Pfaden in eine Baumstruktur (Spanning Tree) auf, die keine redundanten Pfade mehr enthält. Einer der übernimmt dabei die Rolle der Root-Bridge. Die maximal erlaubte Anzahl der Geräte in einem aktiven Ast von der Root-Bridge bis zur Astspitze können Sie durch die Variable `Max Age` der aktuellen Root-Bridge vorgeben. Der voreingestellte Wert für `Max Age` ist 20, er kann bis auf 40 erhöht werden.

Wenn das als Root arbeitende Gerät ausfällt und ein anderes Gerät dessen Funktion übernimmt, bestimmt die neue Root-Bridge die größtmögliche erlaubte Anzahl der Geräte in einem Ast durch ihre `Max Age`-Einstellung.

Anmerkung: Der RSTP-Standard schreibt vor, dass alle Geräte innerhalb eines Netzes mit dem (Rapid-) Spanning-Tree-Algorithmus arbeiten. Bei gleichzeitigem Einsatz von STP und RSTP gehen in den Netz-Segmenten, die gemischt betrieben werden, die Vorteile der schnelleren Rekonfiguration bei RSTP verloren.

Ein Gerät, das lediglich RSTP unterstützt, arbeitet mit MSTP-Geräten zusammen, indem es sich keiner MST-Region, sondern dem CST (Common Spanning Tree) zuordnet.

A.7.1 Grundlagen

Da RSTP eine Weiterentwicklung des STP ist, gelten alle folgenden Beschreibungen des STP auch für das RSTP.

■ Die Aufgaben des STP

Der Spanning Tree-Algorithmus reduziert Netztopologien, die mit Bridges aufgebaut sind und Ringstrukturen durch redundante Verbindungen aufweisen, auf eine Baumstruktur. Dabei trennt STP die Ringstrukturen nach vorgegebenen Regeln auf, indem es redundante Pfade deaktiviert. Wird ein Pfad unterbrochen, weil eine Netzkomponente betriebsunfähig wird, aktiviert das STP den zuvor deaktivierten Pfad wieder. Dies erlaubt

redundante Verbindungen zur Erhöhung der Kommunikationsverfügbarkeit.

Das STP ermittelt bei der Bildung der Baumstruktur eine Bridge, die die Basis der STP-Baumstruktur repräsentiert. Diese Bridge heißt Root-Bridge.

Merkmale des STP-Algorithmus:

- ▶ automatische Rekonfiguration der Baumstruktur bei Bridge-Ausfällen oder Unterbrechung eines Datenpfades,
- ▶ Stabilisierung der Baumstruktur bis zur maximalen Netzausdehnung,
- ▶ Stabilisierung der Topologie innerhalb einer vorhersehbaren Zeit,
- ▶ durch den Administrator vorbestimmbare und reproduzierbare Topologie,
- ▶ Transparenz für die Endgeräte,
- ▶ geringe Netzlast gegenüber der verfügbaren Übertragungskapazität durch Einrichtung der Baumstruktur.

■ Die Bridge-Parameter

Jede Bridge und ihre Verbindungen werden im Kontext von Spanning Tree eindeutig durch die folgenden Parameter beschrieben:

- ▶ Bridge-Identifikation (Bridge-Identifizier),
- ▶ Root-Pfadkosten der Bridge-Ports,
- ▶ Port-Identifikation (Port-Identifizier).

■ Bridge-Identifikation (Bridge-Identifizier)

Die Bridge-Identifikation besteht aus 8 Bytes. Die 2 höchstwertigen Bytes sind die Priorität. Die Voreinstellung für die Prioritätszahl ist 32.768 (8000H), jedoch kann der Management-Administrator diese zur Konfiguration des Netzes verändern. Die 6 niederwertigen Bytes der Bridge-Identifikation sind die MAC-Adresse der Bridge. Die MAC-Adresse ermöglicht, dass alle Bridges eine eindeutige Bridge-Identifikation besitzen. Die Bridge mit dem kleinsten Zahlenwert für die Bridge-Identifikation besitzt die höchste Priorität.



Abb. 6: Bridge-Identifikation, Beispiel (Werte in Hexadezimalschreibweise)

■ Root-Pfadkosten

Jedem Pfad, der 2 Bridges miteinander verbindet, ordnen die Bridges Kosten für die Übertragung (Pfadkosten) zu. Die Bridge bestimmt diesen Wert in Abhängigkeit von der Datenrate (siehe Tabelle 13). Dabei ordnet sie Pfaden mit niedrigerer Datenrate die höheren Pfadkosten zu.

Alternativ dazu kann auch der Administrator die Pfadkosten festlegen. Dabei ordnet er - wie die Bridge - Pfaden mit niedrigerer Datenrate die höheren Pfadkosten zu. Da er aber diesen Wert letztendlich frei wählen kann, verfügt er hiermit über ein Werkzeug, bei redundanten Pfaden einem bestimmten Pfad den Vorzug zu geben.

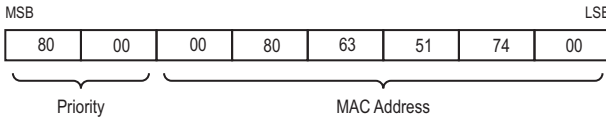
Die Root-Pfadkosten sind die Summe aller Einzelpfadkosten der Pfade, die ein Datenpaket zwischen dem angeschlossenen Port einer Bridge und der Root-Bridge passiert.



Abb. 7: Pfadkosten

Datenrate	Empfohlener Wert	Empfohlener Bereich	Möglicher Bereich
≤100 Kbit/s	200.000.000 ^a	20.000.000-200.000.000	1-200.000.000
1 Mbit/s	20.000.000 ^a	2.000.000-200.000.000	1-200.000.000
10 Mbit/s	2.000.000 ^a	200.000-20.000.000	1-200.000.000
100 Mbit/s	200.000 ^a	20.000-2.000.000	1-200.000.000

Tab. 13: Empfohlene Pfadkosten beim RSTP in Abhängigkeit von der Datenrate.

Datenrate	Empfohlener Wert	Empfohlener Bereich	Möglicher Bereich
1 Gbit/s	20.000	2.000-200.000	1-200.000.000
10 Gbit/s	2.000	200-20.000	1-200.000.000
100 Gbit/s	200	20-2.000	1-200.000.000
1 Tbit/s	20	2-200	1-200.000.000
10 Tbit/s	2	1-20	1-200.000.000

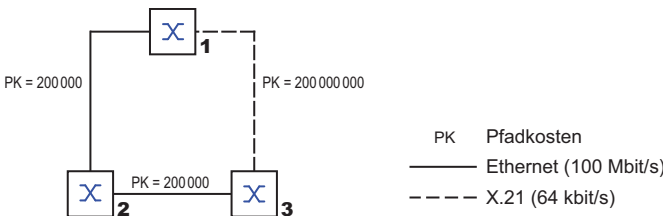
Tab. 13: *Empfohlene Pfadkosten beim RSTP in Abhängigkeit von der Datenrate.*

- a. Bridges, die zu IEEE 802.1D-1998 konform sind, und ausschließlich 16 Bit-Werte für Pfadkosten unterstützen, sollten als Pfadkosten den Wert 65.535 (FFFFH) verwenden, wenn Sie sie zusammen mit Bridges benutzen, die 32 Bit-Werte für die Pfadkosten unterstützen.

■ Portidentifikation

Die Portidentifikation besteht aus 2 Bytes. Ein Teil, das niederwertigste Byte, enthält die physikalischen Portnummer. Dies gewährleistet eine eindeutige Bezeichnung des Port dieser Bridge. Der zweite, höherwertige Teil ist die Port-Priorität, die der Administrator festlegt (Voreinstellung: 128). Auch hier gilt: Der Port mit dem kleinsten Zahlenwert für die Portidentifikation besitzt die höchste Priorität.



Abb. 8: *Portidentifikation*

■ Diameter

Die Größen „MaxAge“ und „Diameter“ bestimmen maßgeblich die maximale Ausdehnung eines Spanning-Tree-Netztes.

Die Anzahl der Verbindungen zwischen den am weitesten voneinander entfernten Geräten im Netz heißt Netzdurchmesser (Diameter).

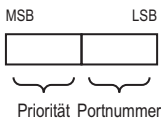

Abb. 9: Definition „Diameter“

Der im Netz erreichbare Netzdurchmesser beträgt $\text{MaxAge}-1$.
 Im Lieferzustand ist $\text{MaxAge}=20$, der maximal erreichbare $\text{Diameter}=19$.
 Wenn Sie für MaxAge den Maximalwert 40 einstellen, ist der maximal erreichbare $\text{Diameter}=39$.

■ MaxAge

Die Größen „MaxAge“ und „Diameter“ bestimmen maßgeblich die maximale Ausdehnung eines Spanning-Tree-Netztes.

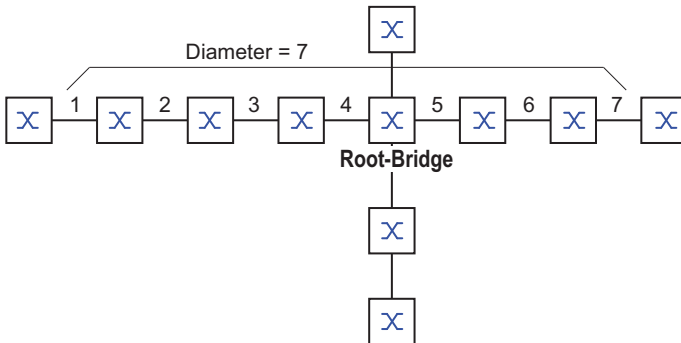
Jede STP-BPDU enthält einen Zähler „MessageAge“. Der Zähler erhöht sich beim Durchlaufen einer Bridge um 1.

Die Bridge vergleicht vor dem Weiterleiten einer STP-BPDU den Zähler „MessageAge“ mit dem im Gerät festgelegten Wert „MaxAge“:

- Ist MessageAge < MaxAge, leitet die Bridge die STP-BPDU an die nächste Bridge weiter.
- Ist MessageAge = MaxAge, verwirft die Bridge die STP-BPDU.

Root-Bridge



Abb. 10: Übertragung einer STP-BPDU in Abhängigkeit von MaxAge

A.7.2 Regeln für die Erstellung der Baumstruktur

■ Bridge-Information

Zur Berechnung der Baumstruktur benötigen die Bridges nähere Informationen über die anderen Bridges, die sich im Netz befinden.

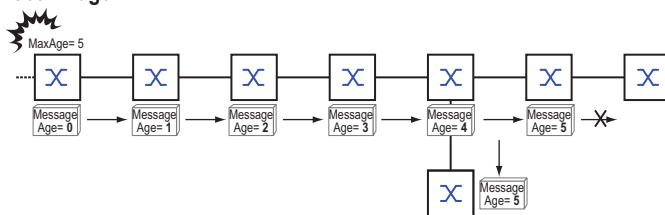
Um diese Informationen zu erhalten, sendet jede Bridge eine BPDUs (Bridge Protocol Data Unit) an andere Bridges.

Bestandteil einer BPDU ist unter anderem die

- ▶ Bridge-Identifikation,
- ▶ Root-Pfadkosten und
- ▶ Port-Identifikation.

(siehe IEEE 802.1D).

■ Aufbauen der Baumstruktur

- ▶ Die Bridge mit dem kleinsten Zahlenwert für die Bridge-Identifikation nennt man auch Root-Bridge. Sie bildet die Root (Wurzel) der Baumstruktur
- ▶ Der Aufbau des Baumes hängt von den Root-Pfadkosten ab. Spanning Tree wählt die Struktur so, dass die minimalen Pfadkosten zwischen jeder einzelnen Bridge zur Root-Bridge entstehen.
- ▶ Bei mehreren Pfaden mit gleichen Root-Pfadkosten entscheidet die von der Root weiter entfernte Bridge, welchen Port sie blockiert. Sie verwendet dazu die Bridge-Identifikationen der näher an der Root liegenden Bridges. Die Bridge blockiert den Port, der zu der Bridge mit der numerisch höheren ID führt (eine numerisch höhere ID ist die logisch schlechtere). Haben 2 Bridges die gleiche Priorität, hat die Bridge mit der numerisch größeren MAC-Adresse die numerisch höhere ID, dies ist die logisch schlechtere.
- ▶ Wenn von einer Bridge mehrere Pfade mit den gleichen Root-Pfadkosten zu der selben Bridge führen, zieht die von der Root weiter entfernte Bridge als letztes Kriterium die Port-Identifikation der anderen Bridge heran (siehe [Abbildung 6](#)). Die Bridge blockiert dabei den Port, der zu dem Port mit der schlechteren ID führt. Haben 2 Ports die selbe Priorität, ist die ID mit der höheren Port-Nr. die schlechtere.



Abb. 11: Flussdiagramm Root-Pfad festlegen

A.7.3 Beispiele

- Beispiel für die Bestimmung des Root-Pfads
Anhand des Netzplanes (siehe [Abbildung 12](#)) kann man das Flussdiagramm (siehe [Abbildung 11](#)) zur Festlegung des Root-Pfads nachvollziehen. Der Administrator hat für jede Bridge eine Priorität in der Bridge-Identifikation festgelegt. Die Bridge mit dem kleinsten Zahlenwert für die Bridge-Identifikation übernimmt die Rolle der Root-Bridge, in diesem Fall die Bridge 1. Im Beispiel belasten alle Teilpfade die gleichen Pfadkosten. Das Protokoll blockiert den Pfad zwischen Bridge 2 und Bridge 3, da eine Verbindung von Bridge 3 über Bridge 2 zur Root-Bridge höhere Pfadkosten verursachen würde.

Interessant ist der Pfad von der Bridge 6 zur Root-Bridge:

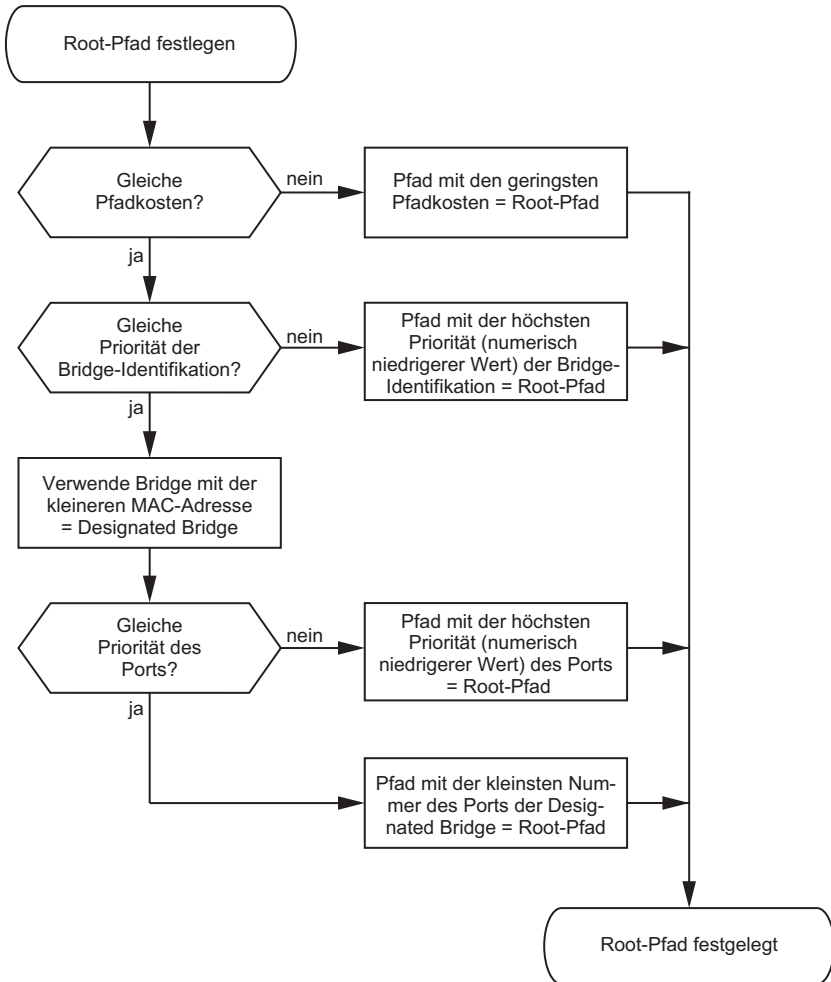
- ▶ Der Pfad über Bridge 5 und Bridge 3 verursacht die gleichen Root-Pfadkosten wie der Pfad über Bridge 4 und Bridge 2.
- ▶ STP wählt den Pfad über die Bridge, die in der Bridge-Identifikation die niedrigere MAC-Adresse hat (im Bild dargestellt Bridge 4).
- ▶ Zwischen Bridge 6 und Bridge 4 gibt es ebenfalls 2 Pfade. Hier entscheidet die Portidentifikation (Port 1 < Port 3).



Abb. 12: Beispiel für die Bestimmung des Root-Pfads

Anmerkung: Indem der Administrator für jede Bridge außer der Root-Bridge den im Lieferzustand voreingestellten Wert der Priorität in der Bridge-Identifikation belässt, bestimmt allein die MAC-Adresse in der Bridge-Identifikation, welche Bridge bei Ausfall der momentanen Root-Bridge die Rolle der neuen Root-Bridge übernimmt.

- Beispiel für die Manipulation des Root-Pfads
- Anhand des Netzplanes (siehe [Abbildung 13](#)) kann man das Flussdiagramm (siehe [Abbildung 11](#)) zur Festlegung des Root-Paths nachvollziehen. Der Administrator hat folgendes getan:
- Für jede Bridge außer Bridge 1 und Bridge 5 hat er den im Lieferzustand voreingestellten Wert von 32.768 (8000H) belassen und
 - der Bridge 1 hat er den Wert 16.384 (4000H) zugewiesen und damit zur Root-Bridge bestimmt.
 - Der Bridge 5 hat er den Wert 28.672 (7000H) zugewiesen.
- Das Protokoll blockiert den Pfad zwischen Bridge 2 und Bridge 3, da eine Verbindung von Bridge 3 über Bridge 2 zur Root-Bridge höhere Pfadkosten bedeutet.

Interessant ist der Pfad von der Bridge 6 zur Root-Bridge:

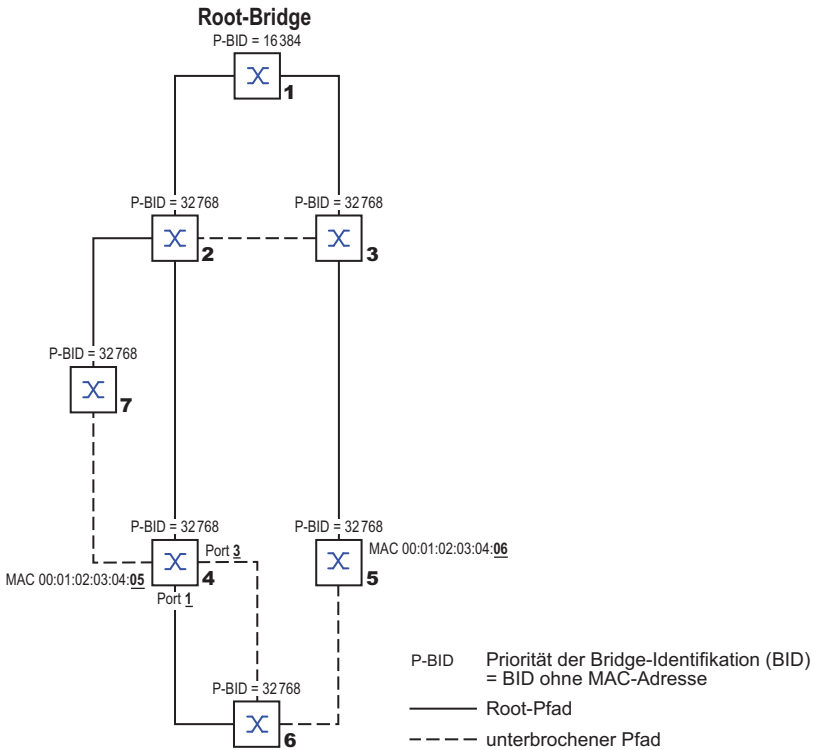
- ▶ Die Bridges wählen den Pfad über Bridge 5, da der Zahlenwert 28.672 für ihre Priorität in der Bridge-Identifikation kleiner ist als der Zahlenwert 32.768.



Abb. 13: Beispiel für die Manipulation des Root-Pfads

- Beispiel für die Manipulation der Baumstruktur
 Der Management-Administrator des Netzes stellt bald fest, dass diese Konfiguration mit Bridge 1 als Root-Bridge (siehe auf Seite 158 „Beispiel für die Bestimmung des Root-Pfads“) ungünstig ist. Auf den Pfaden zwischen Bridge 1 zu Bridge 2 und Bridge 1 zu Bridge 3 summieren sich die Kontrollpakete, die die Root-Bridge zu allen anderen Bridges sendet. Konfiguriert der Management-Administrator die Bridge 2 als Root-Bridge, dann verteilt sich die Belastung der Teilnetze durch Kontrollpakete wesentlich besser. Hieraus entsteht die dargestellte Konfiguration (siehe Abbildung 14). Die Pfadkosten der meisten Bridges zur Root-Bridge sind kleiner geworden.

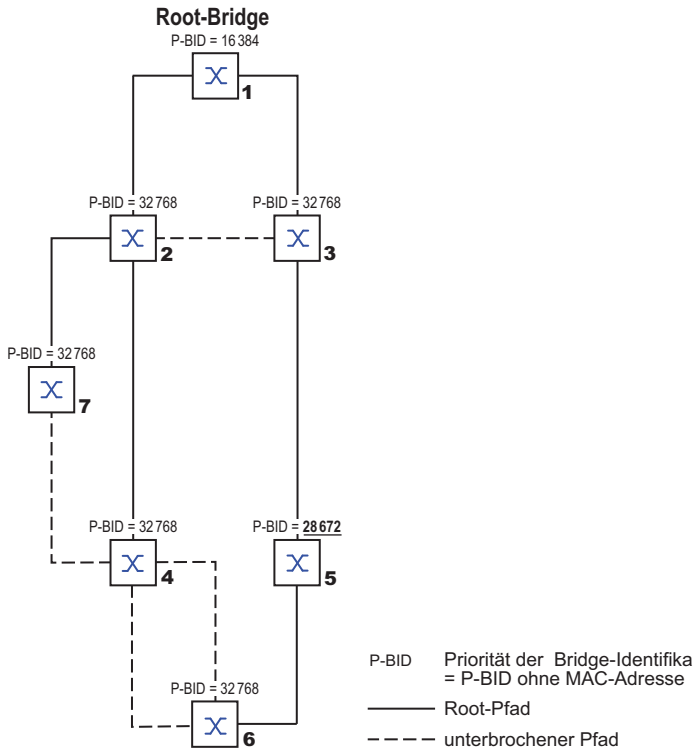
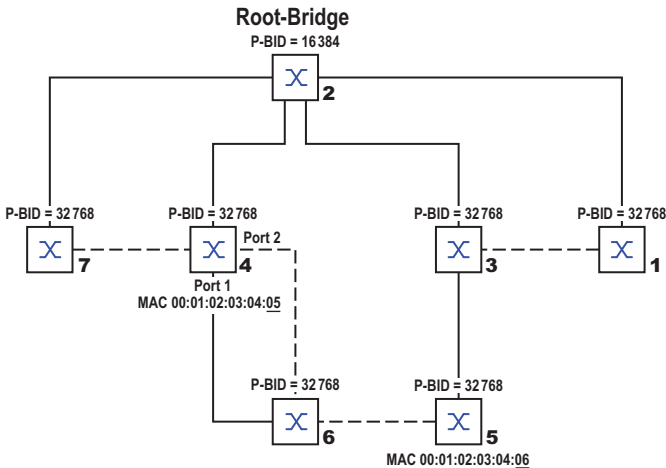

P-BID = Priorität der Bridge-Identifikation (BID)
 = P-BID ohne MAC-Adresse

— Root-Pfad

- - - - unterbrochener Pfad

Abb. 14: Beispiel für die Manipulation der Baumstruktur

A.7.4 Das Rapid Spanning Tree Protokoll

Das RSTP behält die Berechnung der Baumstruktur vom STP unverändert bei. RSTP ändert lediglich Parameter und fügt neue Parameter und Mechanismen hinzu, die die Rekonfiguration beschleunigen, falls eine Verbindung oder eine Bridge ausfällt.

Eine zentrale Bedeutung erfahren in diesem Zusammenhang die Ports.

■ Port-Rollen

RSTP weist jedem Bridge-Port eine der folgenden Rollen zu (siehe [Abbildung 15](#)):

▶ Root-Port:

Dies ist der Port, an dem eine Bridge Datenpakete mit den niedrigsten Pfadkosten von der Root-Bridge empfängt.

Existieren mehrere Ports mit gleich niedrigen Pfadkosten, dann entscheidet die Bridge-Identifikation der zur Root führenden Bridge (Designated Bridge), welchem ihrer Ports die weiter von der Root entfernte Bridge die Rolle des Root-Ports gibt.

Hat eine Bridge mehrere Ports mit gleich niedrigen Pfadkosten zur selben Bridge, entscheidet die Bridge anhand der Portidentifikation der zur Root führenden Bridge (Designated Bridge), welchen Port sie lokal als Root-Port wählt (siehe [Abbildung 11](#)).

Die Root-Bridge selbst besitzt keinen Root-Port.

▶ Designierter Port (Designated-Port):

Die Bridge in einem Netzsegment, die die niedrigsten Root-Pfadkosten hat, ist die designierte Bridge (Designated Bridge).

Haben mehrere Bridges die gleichen Root-Pfadkosten, übernimmt die Bridge mit der zahlenmäßig kleinsten Bridge-Identifikation die Rolle der designierten Bridge. Der designierte Port an dieser Bridge ist der Port, der ein von der Root-Bridge wegführendes Netzsegment verbindet. Ist eine Bridge mit mehr als einem Port mit einem Netzsegment verbunden (z.B. über einen Hub), gibt sie ihrem Port mit der besseren Port-Identifikation die Rolle des Designated Ports.

- ▶ **Edge-Port¹:**
Jedes Netzsegment, in dem sich keine weitere RSTP-Bridge befindet, ist mit genau einem designierten Port verbunden. Dieser designierte Port ist dann gleichzeitig ein Edge-Port, wenn er keine BPDUs (Spanning Tree Bridge Protocol Data Units) empfangen hat.
- ▶ **Alternativer Port (Alternate-Port):**
Dies ist ein blockierter Port, der beim Ausfall der Verbindung zur Root-Bridge die Aufgabe des Root-Ports übernimmt. Der alternative Port stellt die Verbindung der Bridge zur Root-Bridge hin sicher.
- ▶ **Ersatzport (Backup-Port):**
Dies ist ein blockierter Port, der als Ersatz zur Verfügung steht, falls die Verbindung zum designierten Port dieses Netzsegmentes (ohne RSTP-Bridges, z. B. ein Hub) ausfällt.
- ▶ **Deaktivierter Port (Disabled-Port):**
Dies ist ein Port, der innerhalb des Spanning-Tree-Protokolls keine Rolle spielt, also abgeschaltet ist oder keine Verbindung hat.

1. Ein Edge-Port ist ein Endgeräte-Port am „Rand“ (engl. „Edge“) eines geschichteten Netzes.



Abb. 15: Port-Rollen-Zuordnung

■ Port-Status

In Abhängigkeit von der Baumstruktur und dem Status der ausgewählten Verbindungswege weist RSTP den Ports ihren Status zu.

STP Port Status	Administrative Bridge Port-Status	MAC Operational	RSTP Port-Status	Aktive Topology (Port Role)
DISABLED	Disabled	FALSE	Discarding ^a	Excluded (Disabled)
DISABLED	Enabled	FALSE	Discarding ^a	Excluded (Disabled)
BLOCKING	Enabled	TRUE	Discarding ^b	Excluded (Alternate, Backup)
LISTENING	Enabled	TRUE	Discarding ^b	Included (Root, Designated)
LEARNING	Enabled	TRUE	Learning	Included (Root, Designated)
FORWARDING	Enabled	TRUE	Forwarding	Included (Root, Designated)

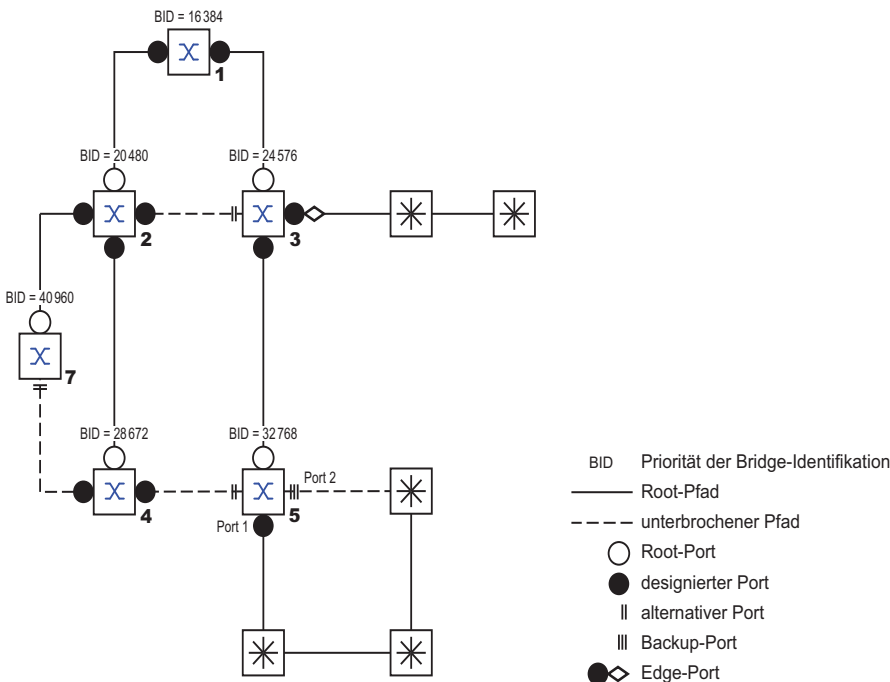
Tab. 14: Beziehung zwischen Port-Status-Werten bei STP und RSTP

- a. Die dot1d-MIB zeigt „Disabled“ an
- b. Die dot1d-MIB zeigt „Blocked“ an

Bedeutung der RSTP-Port-Status:

- ▶ Disabled: Port gehört nicht zur aktiven Topologie
- ▶ Discarding: kein Address Learning in FDB, kein Datenverkehr außer STP-BPDUs
- ▶ Learning: Address Learning aktiv (FDB), kein Datenverkehr außer STP-BPDUs
- ▶ Forwarding: Address Learning aktiv (FDB), Senden und Empfangen aller Frame-Typen (nicht ausschließlich STP-BPDUs)

■ Spanning Tree Priority Vector

Um den Ports Rollen zuzuteilen, tauschen die RSTP-Bridges Konfigurationsinformationen untereinander aus. Diese Informationen heißen "Spanning Tree Priority Vector". Sie sind Teil der RST BPDUs und enthalten folgende Informationen:

- ▶ Bridge-Identifikation der Root-Bridge
- ▶ Root-Pfadkosten der sendenden Bridge
- ▶ Bridge-Identifikation der sendenden Bridge
- ▶ Portidentifikation des Ports, durch den die Nachricht gesendet wurde
- ▶ Portidentifikation des Ports, durch den die Nachricht empfangen wurde

Auf Basis dieser Informationen sind die am RSTP beteiligten Bridges in der Lage, selbständig Port-Rollen zu bestimmen und den Port-Status ihrer lokalen Ports zu definieren.

- **Schnelle Rekonfiguration**
Warum kann RSTP schneller als STP auf eine Unterbrechung des Root-Pfades reagieren?
 - ▶ **Einführung von Edge-Ports:**
Bei einer Rekonfiguration setzt RSTP einen Edge-Port nach Ablauf von 3 Sekunden (Voreinstellung) in den Vermittlungsmodus und wartet dann "Hello Time" ab, um sich zu vergewissern, dass keine BPDU-sendende Bridge angeschlossen ist.
Wenn der Anwender sicherstellt, dass an diesem Port ein Endgerät angeschlossen ist und bleibt, entstehen im Rekonfigurationsfall an diesem Port keine Wartezeiten
 - ▶ **Einführung von alternativen Ports:**
Da schon im regulären Betrieb die Portrollen verteilt sind, kann eine Bridge nach dem Verlust der Verbindung zur Root-Bridge vom Root-Port zu einem alternativen Port umschalten.
 - ▶ **Kommunikation mit Nachbar-Bridges (Punkt-zu-Punkt-Verbindungen):**
Die dezentrale, direkte Kommunikation zwischen benachbarten Bridges erlaubt ohne Wartezeiten eine Reaktion auf Zustandsänderungen der Spanning-Tree-Topologie.
 - ▶ **Adresstabelle:**
Beim STP bestimmt das Alter der Einträge in der FDB über die Aktualisierung der Kommunikation. Das RSTP löscht sofort und gezielt die Einträge der Ports, die von einer Umkonfiguration betroffen sind.
 - ▶ **Reaktion auf Ereignisse:**
Ohne Zeitvorgaben einhalten zu müssen, reagiert RSTP sofort auf Ereignisse wie Verbindungsunterbrechung, Verbindung vorhanden, u.a.

Anmerkung: Die Kehrseite dieser schnellen Rekonfiguration ist die Möglichkeit, dass Datenpakete während der Rekonfigurationsphase der RSTP-Topologie dupliziert und/oder mit vertauschter Reihenfolge beim Empfänger ankommen können. Wenn Sie dies in Ihrer Anwendung nicht akzeptieren können, dann benutzen Sie das langsamere Spanning Tree Protokoll oder wählen Sie eines der anderen in diesem Buch beschriebenen, schnelleren Redundanzverfahren.

■ STP-Kompatibilitätsmodus

Der STP-Kompatibilitätsmodus bietet Ihnen die Möglichkeit, RSTP-Geräte in Netzen mit Alt-Installationen zu betreiben. Erkennt ein RSTP-Gerät ein älteres STP-Gerät, schaltet es am betreffenden Port den STP-Kompatibilitätsmodus ein.

A.8 Grundlagen Topologie-Erkennung

IEEE 802.1AB beschreibt das Link Layer Discovery Protocol (LLDP). Das LLDP ermöglicht dem Anwender eine automatische Topologie-Erkennung seines LANs.

Geräte mit aktivem LLDP:

- ▶ senden ihre Verbindungs- und Verwaltungsdaten an die angrenzenden Geräte des gemeinsamen LANs. Die Bewertung der Geräte erfolgt, wenn die LLDP-Funktion beim empfangenden Gerät aktiviert ist.
- ▶ empfangen eigene Verbindungs- und Management-Informationen von angrenzenden Geräten des gemeinsamen LANs, sofern diese auch das LLDP aktiviert haben.
- ▶ erzeugen eine Datenbank mit Management-Informationen und Objektdefinitionen über angrenzende Geräte, die auch das LLDP aktiviert haben.

Als zentrales Element enthält die Verbindungsinformation die genaue, eindeutige Kennzeichnung des Verbindungsendpunktes: MAC (Dienstzugangspunkt) Diese setzt sich zusammen aus einer netzweit eindeutigen Geräteerkennung und einer für dieses Gerät eindeutigen Port-Kennung.

Inhalt der Verbindungs- und Management-Informationen:

- ▶ Chassis-Kennung (dessen MAC-Adresse)
- ▶ Port-Kennung (dessen Port-MAC-Adresse)
- ▶ Beschreibung des Ports
- ▶ Systemname
- ▶ Systembeschreibung
- ▶ Unterstützte Systemfunktionen
- ▶ Momentan aktive Systemfunktionen
- ▶ Interface-ID der Management-Adresse
- ▶ VLAN-ID des Ports
- ▶ Status der Auto-Negotiation am Port
- ▶ Einstellung für Medium-/Halb- und Voll-Duplex sowie für die Port-Geschwindigkeit
- ▶ Information über die im Gerät installierten VLANs (VLAN-Kennung und VLAN-Namen; unabhängig davon, ob der Port VLAN-Mitglied ist).

Diese Informationen kann eine Netzmanagementstation von Geräten mit aktivem LLDP abrufen. Mit diesen Informationen ist die Netzmanagementstation in der Lage, die Topologie des Netzes darzustellen.

802.1d-Geräte blockieren in der Regel die spezielle zum Informationsaustausch verwendete Multicast-LLDP-IEEE-MAC-Adresse. Nicht-LLDP-Geräte werfen aus diesem Grund LLDP-Pakete. Wird ein nicht-LLDP-fähiges Gerät zwischen 2 LLDP-fähigen Geräten positioniert, lässt das nicht-LLDP-fähige Gerät den Informationsaustausch zwischen 2 LLDP-fähigen Geräten nicht zu.

Die Management Information Base (MIB) für ein LLDP-fähiges Gerät enthält die LLDP-Informationen in der LLDP-MIB.

A.9 Grundlagen Priorisierung des Datenverkehrs

A.9.1 Beschreibung Priorisierung

Zur Priorisierung des Datenverkehrs sind im Gerät Verkehrsklassen („Traffic Classes“) vordefiniert. Höhere Verkehrsklassen priorisiert das Gerät gegenüber niedrigeren Verkehrsklassen.

Um verzögerungsempfindlichen Daten einen optimierten Datenfluss zu bieten, weisen Sie diesen Daten höhere Verkehrsklassen zu. Weniger verzögerungsempfindlichen Daten weisen Sie entsprechend niedrigere Verkehrsklassen zu.

■ Den Daten Verkehrsklassen zuweisen

Das Gerät ordnet eingehenden Daten automatisch Verkehrsklassen zu (Verkehrsklassifizierung). Das Gerät berücksichtigt folgende Klassifizierungskriterien:

- ▶ Methode, gemäß derer das Gerät die Zuordnung empfangener Datenpakete zu den Verkehrsklassen durchführt:
 - ▶ `trustDot1p`: Das Gerät verwendet die im VLAN-Tag enthaltene Priorität des Datenpaketes.
 - ▶ `trustIpDscp`: Das Gerät verwendet die im IP-Header enthaltene QoS-Information (ToS/DiffServ).
 - ▶ `untrusted`: Das Gerät ignoriert mögliche Prioritätsinformationen innerhalb der Datenpakete und verwendet direkt die Priorität des Empfangsports.
- ▶ Die Priorität, die dem Empfangsport zugewiesen ist.

Beide Klassifizierungskriterien sind konfigurierbar.

■ Die Verkehrsklassen priorisieren

Zur Priorisierung von Verkehrsklassen verwendet das Gerät die Methode „Strict“.

Wenn kein Versand von Daten einer höheren Verkehrsklasse mehr stattfindet oder die betreffenden Daten noch in der Warteschlange stehen, sendet das Gerät Daten der entsprechenden Verkehrsklasse. Wenn alle Verkehrsklassen nach der Methode „Strict“ priorisiert sind, blockiert das Gerät bei hoher Netzlast die Daten niedrigerer Verkehrsklassen möglicherweise permanent.

A.9.2 Behandlung empfangener Prioritätsinformationen

Anwendungen kennzeichnen Datenpakete mit folgenden Priorisierungs-Informationen:

- ▶ VLAN-Priorität nach IEEE 802.1Q/ 802.1D (Layer 2)
- ▶ Type-of-Service (ToS) oder DiffServ (DSCP) bei VLAN Management IP-Paketen (Layer 3)

Das Gerät bietet folgende Möglichkeiten, diese Prioritätsinformation auszuwerten:

- ▶ `trustDot1p`
Das Gerät ordnet VLAN-getaggte Datenpakete entsprechend ihrer VLAN-Priorität den unterschiedlichen Verkehrsklassen zu. Die entsprechende Zuordnung ist konfigurierbar. Das Gerät ordnet Datenpaketen, die es ohne VLAN-Tag empfängt, die Priorität des Empfangsports zu.
- ▶ `trustIpDscp`
Das Gerät ordnet IP-Pakete gemäß dem DSCP-Wert im IP-Header den unterschiedlichen Verkehrsklassen zu, auch wenn das Paket zusätzlich VLAN-getagg war. Die entsprechende Zuordnung ist konfigurierbar. Nicht-IP-Pakete priorisiert das Gerät entsprechend der Priorität des Empfangsports.
- ▶ `untrusted`
Das Gerät ignoriert die Prioritätsinformationen in Datenpaketen und weist den Paketen die Priorität des Empfangsports zu.

A.9.3 VLAN-Tagging

Für die Funktionen VLAN und Priorisierung sieht die Norm IEEE 802.1Q die Einbindung eines VLAN-Tags in den MAC-Datenrahmen vor. Das VLAN-Tag besteht aus 4 Bytes und steht zwischen dem Quelladressfeld („Source Address Field“) und dem Typfeld („Length/Type Field“).



Abb. 16: Ethernet-Datenpaket mit Tag

Das Gerät wertet bei Datenpaketen mit VLAN-Tags die Prioritätsinformation aus.

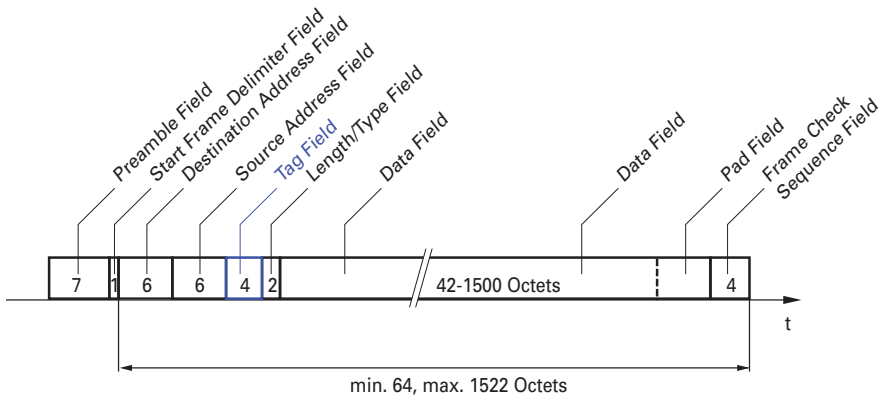

Abb. 17: Aufbau der VLAN-Markierung

Ein Datenpaket, dessen VLAN-Markierung eine Prioritätsinformation, aber keine VLAN-Information (VLAN-Kennung = 0) enthält, bezeichnet man als „Priority Tagged Frame“.

Anmerkung: Netzprotokolle und Redundanzmechanismen nutzen die höchste Verkehrsklasse 7. Wählen Sie für Anwendungsdaten deshalb niedrigere Verkehrsklassen.

Beachten Sie beim Einsatz der VLAN-Priorisierung folgende Besonderheiten:

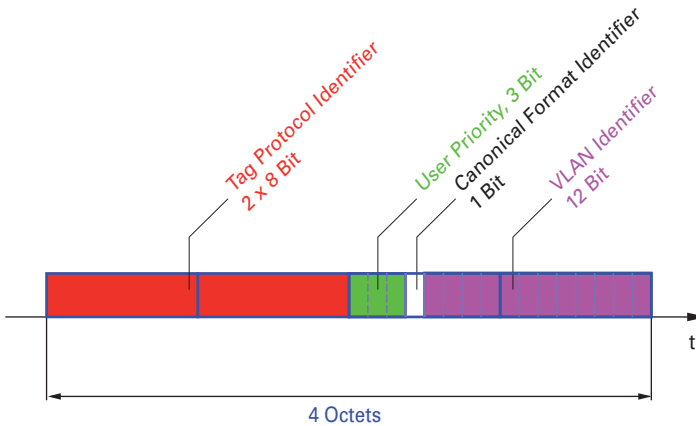
- ▶ Eine Ende-zu-Ende-Priorisierung erfordert die durchgängige Übertragung der VLAN-Tags im gesamten Netz. Voraussetzung ist, dass jede beteiligte Netzkomponente VLAN-fähig ist.
- ▶ Router haben keine Möglichkeit, über Port-basierte Router-Interfaces Pakete mit VLAN-Tag zu empfangen und zu senden.

A.9.4 Handhabung der Verkehrsklassen

■ Beschreibung Strict-Priority

Bei Strict-Priority vermittelt das Gerät zuerst die Datenpakete mit höherer Verkehrsklasse (höherer Priorität), bevor es ein Datenpaket mit der nächst niedrigeren Verkehrsklasse vermittelt. Ein Datenpaket mit der niedrigsten Verkehrsklasse (niedrigsten Priorität) vermittelt das Gerät demnach erst, wenn keine anderen Datenpakete mehr in der Warteschlange stehen. In ungünstigen Fällen sendet das Gerät Pakete mit niedriger Priorität nie, wenn an diesem Port ein hohes Aufkommen von höherprioriem Verkehr zum Senden ansteht.

Bei verzögerungsempfindlichen Anwendungen wie VoIP oder Video ermöglicht Strict-Priority das unmittelbare Senden hochpriorer Daten.

A.10 Grundlagen Flusskontrolle

Treffen in der Sendewarteschlange eines Ports sehr viele Datenpakete gleichzeitig ein, führt dies möglicherweise zum Überlaufen des Portspeichers. Beispielsweise passiert dies dann, wenn das Gerät Daten an einem Gigabit-Port empfängt und diese an einen Port mit niedrigerer Bandbreite weiterleitet. Das Gerät verwirft überschüssige Datenpakete.

Der in der Norm IEEE 802.3 beschriebene Flusskontrollmechanismus sorgt dafür, dass keine Datenpakete durch Überlaufen eines Portspeichers verloren gehen. Kurz bevor ein Portspeicher vollständig gefüllt ist, signalisiert das Gerät den angeschlossenen Geräten, dass es keine Datenpakete von ihnen mehr annimmt.

- ▶ Im Vollduplex-Betrieb sendet das Gerät ein Pause-Datenpaket.
- ▶ Im Halbduplex-Betrieb simuliert das Gerät eine Kollision.

Die folgende Abbildung zeigt die Wirkungsweise der Flusskontrolle. Die Workstations 1, 2 und 3 wollen zur gleichen Zeit viele Daten an die Workstation 4 übertragen. Die gemeinsame Bandbreite der Workstations 1, 2 und 3 ist größer als die Bandbreite von Workstation 4. So kommt es zum Überlaufen der Empfangs-Warteschlange von Port 4. Der linke Trichter symbolisiert diesen Zustand.

Wenn an den Ports 1, 2 und 3 des Gerätes die Funktion Flusskontrolle eingeschaltet ist, reagiert das Gerät, bevor der Trichter überläuft. Der Trichter auf der rechten Seite veranschaulicht die Ports 1, 2 und 3, die zwecks Kontrolle der Übertragungsgeschwindigkeit eine Nachricht an die übertragenden Geräte senden. Als Resultat hiervon wird der Empfangsport nicht länger überfordert und ist in der Lage, den eingehenden Verkehr zu verarbeiten.



Abb. 18: Beispiel für Flusskontrolle

A.10.1 Halbduplex- oder Vollduplex-Verbindung

■ Flusskontrolle bei Halbduplex-Verbindung

Im Beispiel besteht zwischen der Arbeitsstation 2 und dem Gerät eine Halbduplex-Verbindung.

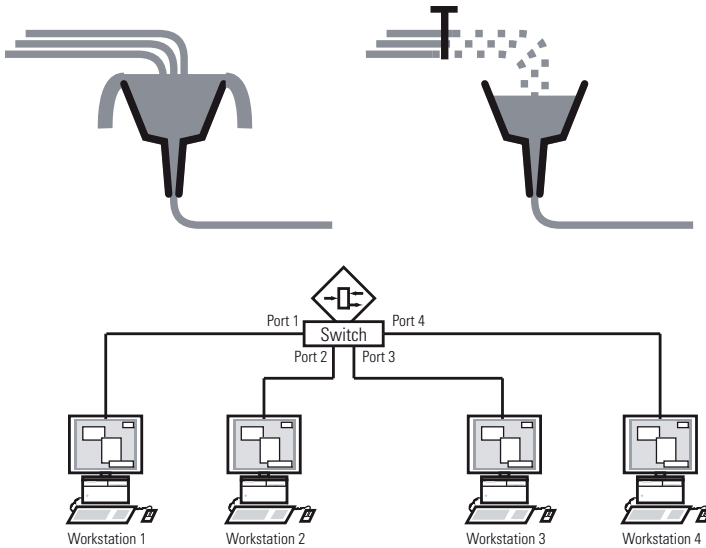
Bevor die Sende-Warteschlange von Port 2 überläuft, sendet das Gerät Daten zurück an Arbeitsstation 2. Arbeitsstation 2 erkennt eine Kollision und unterbricht den Sendevorgang.

■ Flusskontrolle bei Vollduplex-Verbindung

Im Beispiel besteht zwischen der Arbeitsstation 2 und dem Gerät eine Vollduplex-Verbindung.

Bevor die Sende-Warteschlange von Port 2 überläuft, sendet das Gerät eine Aufforderung an Arbeitsstation 2, beim Senden eine kleine Pause einzulegen.

A.11 Grundlagen Management Information BASE (MIB)

Die Management Information Base (MIB) ist als abstrakte Baumstruktur angelegt.

Die Verzweigungspunkte sind die Objektklassen. Die „Blätter“ der MIB tragen die Bezeichnung generische Objektklassen.

Die Instanzierung der generischen Objektklassen, das heißt, die abstrakte Struktur auf die Realität abzubilden, erfolgt z.B. durch die Angabe des Ports oder der Quelladresse (Source Address), soweit dies zur eindeutigen Identifizierung nötig ist.

Diesen Instanzen sind Werte (Integer, TimeTicks, Counter oder Octet String) zugeordnet, die gelesen und teilweise auch verändert werden können. Die Object Description oder der Object-ID (OID) bezeichnet die Objektklasse. Mit dem Subidentifizier (SID) werden sie instanziiert.

Beispiel:

Die generische Objektklasse

hm2PSState (OID = 1.3.6.1.4.1.248.11.11.1.1.1.1.2)

ist die Beschreibung der abstrakten Information „Netzteilstatus“. Es lässt sich daraus noch kein Wert auslesen, es ist ja auch noch nicht bekannt, welches Netzteil gemeint ist.

Durch die Angabe des Subidentifiziers (2) wird diese abstrakte Information auf die Wirklichkeit abgebildet, instanziiert, und bezeichnet so den Betriebszustand des Netzteils 2. Diese Instanz bekommt einen Wert zugewiesen, der gelesen werden kann. Damit liefert die Instanz „get

1.3.6.1.4.1.248.11.11.1.1.1.1.2.1“ als Antwort „1“, das heißt, das Netzteil ist betriebsbereit.

Definition der verwendeten Syntaxbegriffe:

Integer	Ganze Zahl im Bereich von -2^{31} - $2^{31}-1$
IP-Adresse	xxx.xxx.xxx.xxx (xxx = ganze Zahl im Bereich von 0-255)
MAC-Adresse	12-stellige Hexzahl nach ISO/IEC 8802-3
Object Identifier	x.x.x.x... (z. B. 1.3.6.1.4.1.248...)
Octet String	ASCII-Zeichen-Kette

Definition der verwendeten Syntaxbegriffe:	
PSID	Spannungsversorgungsidentifikation (Nummer des Netzteils)
TimeTicks	Stop-Uhr, verronnene Zeit = Zahlenwert/100 in Sekunden Zahlenwert = ganze Zahl im Bereich von $0-2^{32}-1$
Timeout	Zeitwert in hundertstel Sekunden Zeitwert = ganze Zahl im Bereich von $0-2^{32}-1$
Typfeld	4-stellige Hexzahl nach ISO/IEC 8802-3
Zähler	Ganze Zahl ($0-2^{32}-1$), deren Wert beim Auftreten bestimmter Ereignisse um 1 erhöht wird.

A.12 Copyright integrierter Software

A.12.1 Included open source software

This product includes the following open source software originated from third parties that is subject to the GNU General Public License (GPL), GNU Lesser General Public License (LGPL). You can find a copy of the licences in chapter „[GNU GENERAL PUBLIC LICENSE](#)“ and „[GNU LESSER GENERAL PUBLIC LICENSE](#)“.

- BusyBox
- Open-LLDP
- Log Writer Library (LWL)
- rstplib
- U-Boot
- tinystest
- Linux

■ GNU GENERAL PUBLIC LICENSE Version 2, June 1991

Copyright (C) 1989, 1991 Free Software Foundation, Inc., 51 Franklin Street, Fifth Floor, Boston, MA 02110-1301 USA

Everyone is permitted to copy and distribute verbatim copies of this license document, but changing it is not allowed.

Preamble

The licenses for most software are designed to take away your freedom to share and change it. By contrast, the GNU General Public License is intended to guarantee your freedom to share and change free software--to make sure the software is free for all its users. This General Public License applies to most of the Free Software Foundation's software and to any other program whose authors commit to using it. (Some other Free Software Foundation software is covered by the GNU Lesser General Public License instead.) You can apply it to your programs, too.

When we speak of free software, we are referring to freedom, not price. Our General Public Licenses are designed to make sure that you have the freedom to distribute copies of free software (and charge for this service if you wish), that you receive source code or can get it if you want it, that you can change the software or use pieces of it in new free programs; and that you know you can do these things.

To protect your rights, we need to make restrictions that forbid anyone to deny you these rights or to ask you to surrender the rights.

These restrictions translate to certain responsibilities for you if you distribute copies of the software, or if you modify it.

For example, if you distribute copies of such a program, whether gratis or for a fee, you must give the recipients all the rights that you have. You must make sure that they, too, receive or can get the source code. And you must show them these terms so they know their rights.

We protect your rights with two steps: (1) copyright the software, and (2) offer you this license which gives you legal permission to copy, distribute and/or modify the software.

Also, for each author's protection and ours, we want to make certain that everyone understands that there is no warranty for this free software. If the software is modified by someone else and passed on, we want its recipients to know that what they have is not the original, so that any problems introduced by others will not reflect on the original authors' reputations.

Finally, any free program is threatened constantly by software patents. We wish to avoid the danger that redistributors of a free program will individually obtain patent licenses, in effect making the program proprietary. To prevent this, we have made it clear that any patent must be licensed for everyone's free use or not licensed at all.

The precise terms and conditions for copying, distribution and modification follow.

GNU GENERAL PUBLIC LICENSE TERMS AND CONDITIONS FOR COPYING, DISTRIBUTION AND MODIFICATION

0. This License applies to any program or other work which contains a notice placed by the copyright holder saying it may be distributed under the terms of this General Public License. The "Program", below, refers to any such program or work, and a "work based on the Program" means either the Program or any derivative work under copyright law: that is to say, a work containing the Program or a portion of it, either verbatim or with modifications and/or translated into another language. (Hereinafter, translation is included without limitation in the term "modification".) Each licensee is addressed as "you".

Activities other than copying, distribution and modification are not covered by this License; they are outside its scope. The act of running the Program is not restricted, and the output from the Program is covered only if its contents constitute a work based on the Program (independent of having been made by running the Program). Whether that is true depends on what the Program does.

1. You may copy and distribute verbatim copies of the Program's source code as you receive it, in any medium, provided that you conspicuously and appropriately publish on each copy an appropriate copyright notice and disclaimer of warranty; keep intact all the notices that refer to this License and to the absence of any warranty; and give any other recipients of the Program a copy of this License along with the Program.

You may charge a fee for the physical act of transferring a copy, and you may at your option offer warranty protection in exchange for a fee.

2. You may modify your copy or copies of the Program or any portion of it, thus forming a work based on the Program, and copy and distribute such modifications or work under the terms of Section 1 above, provided that you also meet all of these conditions:

a) You must cause the modified files to carry prominent notices stating that you changed the files and the date of any change.

b) You must cause any work that you distribute or publish, that in whole or in part contains or is derived from the Program or any part thereof, to be licensed as a whole at no charge to all third parties under the terms of this License.

c) If the modified program normally reads commands interactively when run, you must cause it, when started running for such interactive use in the most ordinary way, to print or display an announcement including an appropriate copyright notice and a notice that there is no warranty (or else, saying that you provide a warranty) and that users may redistribute the program under these conditions, and telling the user how to view a copy of this License. (Exception: if the Program itself is interactive but does not normally print such an announcement, your work based on the Program is not required to print an announcement.)

These requirements apply to the modified work as a whole. If identifiable sections of that work are not derived from the Program, and can be reasonably considered independent and separate works in themselves, then this License, and its terms, do not apply to those sections when you distribute them as separate works.

But when you distribute the same sections as part of a whole which is a work based on the Program, the distribution of the whole must be on the terms of this License, whose permissions for other licensees extend to the entire whole, and thus to each and every part regardless of who wrote it. Thus, it is not the intent of this section to claim rights or contest your rights to work written entirely by you; rather, the intent is to exercise the right to control the distribution of derivative or collective works based on the Program.

In addition, mere aggregation of another work not based on the Program with the Program (or with a work based on the Program) on a volume of a storage or distribution medium does not bring the other work under the scope of this License.

3. You may copy and distribute the Program (or a work based on it, under Section 2) in object code or executable form under the terms of Sections 1 and 2 above provided that you also do one of the following:

a) Accompany it with the complete corresponding machine-readable source code, which must be distributed under the terms of Sections 1 and 2 above on a medium customarily used for software interchange; or,

- b) Accompany it with a written offer, valid for at least three years, to give any third party, for a charge no more than your cost of physically performing source distribution, a complete machine-readable copy of the corresponding source code, to be distributed under the terms of Sections 1 and 2 above on a medium customarily used for software interchange; or,
- c) Accompany it with the information you received as to the offer to distribute corresponding source code. (This alternative is allowed only for non-commercial distribution and only if you received the program in object code or executable form with such an offer, in accord with Subsection b above.)

The source code for a work means the preferred form of the work for making modifications to it. For an executable work, complete source code means all the source code for all modules it contains, plus any associated interface definition files, plus the scripts used to control compilation and installation of the executable. However, as a special exception, the source code distributed need not include anything that is normally distributed (in either source or binary form) with the major components (compiler, kernel, and so on) of the operating system on which the executable runs, unless that component itself accompanies the executable.

If distribution of executable or object code is made by offering access to copy from a designated place, then offering equivalent access to copy the source code from the same place counts as distribution of the source code, even though third parties are not compelled to copy the source along with the object code.

4. You may not copy, modify, sublicense, or distribute the Program except as expressly provided under this License. Any attempt otherwise to copy, modify, sublicense or distribute the Program is void, and will automatically terminate your rights under this License. However, parties who have received copies, or rights, from you under this License will not have their licenses terminated so long as such parties remain in full compliance.

5. You are not required to accept this License, since you have not signed it. However, nothing else grants you permission to modify or distribute the Program or its derivative works. These actions are prohibited by law if you do not accept this License. Therefore, by modifying or distributing the Program (or any work based on the Program), you indicate your acceptance of this License to do so, and all its terms and conditions for copying, distributing or modifying the Program or works based on it.

6. Each time you redistribute the Program (or any work based on the Program), the recipient automatically receives a license from the original licensor to copy, distribute or modify the Program subject to these terms and conditions. You may not impose any further restrictions on the recipients' exercise of the rights granted herein. You are not responsible for enforcing compliance by third parties to this License.

7. If, as a consequence of a court judgment or allegation of patent infringement or for any other reason (not limited to patent issues), conditions are imposed on you (whether by court order, agreement or otherwise) that contradict the conditions of this License, they do not excuse you from the conditions of this License. If you cannot distribute so as to satisfy simultaneously your obligations under this License and any other pertinent obligations, then as a consequence you may not distribute the Program at all. For example, if a patent license would not permit royalty-free redistribution of the Program by all those who receive copies directly or indirectly through you, then the only way you could satisfy both it and this License would be to refrain entirely from distribution of the Program.

If any portion of this section is held invalid or unenforceable under any particular circumstance, the balance of the section is intended to apply and the section as a whole is intended to apply in other circumstances.

It is not the purpose of this section to induce you to infringe any patents or other property right claims or to contest validity of any such claims; this section has the sole purpose of protecting the integrity of the free software distribution system, which is implemented by public license practices. Many people have made generous contributions to the wide range of software distributed through that system in reliance on consistent application of that system; it is up to the author/donor to decide if he or she is willing to distribute software through any other system and a licensee cannot impose that choice.

This section is intended to make thoroughly clear what is believed to be a consequence of the rest of this License.

8. If the distribution and/or use of the Program is restricted in certain countries either by patents or by copyrighted interfaces, the original copyright holder who places the Program under this License may add an explicit geographical distribution limitation excluding those countries, so that distribution is permitted only in or among countries not thus excluded. In such case, this License incorporates the limitation as if written in the body of this License.

9. The Free Software Foundation may publish revised and/or new versions of the General Public License from time to time. Such new versions will be similar in spirit to the present version, but may differ in detail to address new problems or concerns.

Each version is given a distinguishing version number. If the Program specifies a version number of this License which applies to it and "any later version", you have the option of following the terms and conditions either of that version or of any later version published by the Free Software Foundation. If the Program does not specify a version number of this License, you may choose any version ever published by the Free Software Foundation.

10. If you wish to incorporate parts of the Program into other free programs whose distribution conditions are different, write to the author to ask for permission. For software which is copyrighted by the Free Software Foundation, write to the Free Software Foundation; we sometimes make exceptions for this. Our decision will be guided by the two goals of preserving the free status of all derivatives of our free software and of promoting the sharing and reuse of software generally.

NO WARRANTY

11. BECAUSE THE PROGRAM IS LICENSED FREE OF CHARGE, THERE IS NO WARRANTY FOR THE PROGRAM, TO THE EXTENT PERMITTED BY APPLICABLE LAW.

EXCEPT WHEN OTHERWISE STATED IN WRITING THE COPYRIGHT HOLDERS AND/OR OTHER PARTIES PROVIDE THE PROGRAM "AS IS" WITHOUT WARRANTY OF ANY KIND, EITHER EXPRESSED OR IMPLIED, INCLUDING, BUT NOT LIMITED TO, THE IMPLIED WARRANTIES OF MERCHANTABILITY AND FITNESS FOR A PARTICULAR PURPOSE. THE ENTIRE RISK AS TO THE QUALITY AND PERFORMANCE OF THE PROGRAM IS WITH YOU. SHOULD THE PROGRAM PROVE DEFECTIVE, YOU ASSUME THE COST OF ALL NECESSARY SERVICING, REPAIR OR CORRECTION.

12. IN NO EVENT UNLESS REQUIRED BY APPLICABLE LAW OR AGREED TO IN WRITING WILL ANY COPYRIGHT HOLDER, OR ANY OTHER PARTY WHO MAY MODIFY AND/OR REDISTRIBUTE THE PROGRAM AS PERMITTED ABOVE, BE LIABLE TO YOU FOR DAMAGES, INCLUDING ANY GENERAL, SPECIAL, INCIDENTAL OR CONSEQUENTIAL DAMAGES ARISING OUT OF THE USE OR INABILITY TO USE THE PROGRAM (INCLUDING BUT NOT LIMITED TO LOSS OF DATA OR DATA BEING RENDERED INACCURATE OR LOSSES SUSTAINED BY YOU OR THIRD PARTIES OR A FAILURE OF THE PROGRAM TO OPERATE WITH ANY OTHER PROGRAMS), EVEN IF SUCH HOLDER OR OTHER PARTY HAS BEEN ADVISED OF THE POSSIBILITY OF SUCH DAMAGES.

END OF TERMS AND CONDITIONS

How to Apply These Terms to Your New Programs

If you develop a new program, and you want it to be of the greatest possible use to the public, the best way to achieve this is to make it free software which everyone can redistribute and change under these terms.

To do so, attach the following notices to the program. It is safest to attach them to the start of each source file to most effectively convey the exclusion of warranty; and each file should have at least the "copyright" line and a pointer to where the full notice is found.

<one line to give the program's name and a brief idea of what it does.>
Copyright (C) <year> <name of author>

This program is free software; you can redistribute it and/or modify it under the terms of the GNU General Public License as published by the Free Software Foundation; either version 2 of the License, or (at your option) any later version.

This program is distributed in the hope that it will be useful, but WITHOUT ANY WARRANTY; without even the implied warranty of MERCHANTABILITY or FITNESS FOR A PARTICULAR PURPOSE. See the GNU General Public License for more details.

You should have received a copy of the GNU General Public License along with this program; if not, write to the Free Software Foundation, Inc., 51 Franklin Street, Fifth Floor, Boston, MA 02110-1301 USA.

Also add information on how to contact you by electronic and paper mail. If the program is interactive, make it output a short notice like this when it starts in an interactive mode:

Gnomovision version 69, Copyright (C) year name of author Gnomovision comes with ABSOLUTELY NO WARRANTY; for details type `show w'. This is free software, and you are welcome to redistribute it under certain conditions; type `show c' for details.

The hypothetical commands `show w' and `show c' should show the appropriate parts of the General Public License. Of course, the commands you use may be called something other than `show w' and `show c'; they could even be mouse-clicks or menu items--whatever suits your program.

You should also get your employer (if you work as a programmer) or your school, if any, to sign a "copyright disclaimer" for the program, if necessary. Here is a sample; alter the names:

Yoyodyne, Inc., hereby disclaims all copyright interest in the program `Gnomovision' (which makes passes at compilers) written by James Hacker.

<signature of Ty Coon>, 1 April 1989
Ty Coon, President of Vice

This General Public License does not permit incorporating your program into proprietary programs. If your program is a subroutine library, you may consider it more useful to permit linking proprietary applications with the library. If this is what you want to do, use the GNU Lesser General Public License instead of this License.

■ GNU LESSER GENERAL PUBLIC LICENSE Version 2.1, February 1999

Copyright (C) 1991, 1999 Free Software Foundation, Inc.
51 Franklin Street, Fifth Floor, Boston, MA 02110-1301 USA
Everyone is permitted to copy and distribute verbatim copies of this license document, but changing it is not allowed.

[This is the first released version of the Lesser GPL. It also counts as the successor of the GNU Library Public License, version 2, hence the version number 2.1.]

Preamble

The licenses for most software are designed to take away your freedom to share and change it. By contrast, the GNU General Public Licenses are intended to guarantee your freedom to share and change free software--to make sure the software is free for all its users.

This license, the Lesser General Public License, applies to some specially designated software packages--typically libraries--of the Free Software Foundation and other authors who decide to use it. You can use it too, but we suggest you first think carefully about whether this license or the ordinary General Public License is the better strategy to use in any particular case, based on the explanations below.

When we speak of free software, we are referring to freedom of use, not price. Our General Public Licenses are designed to make sure that you have the freedom to distribute copies of free software (and charge for this service if you wish); that you receive source code or can get it if you want it; that you can change the software and use pieces of it in new free programs; and that you are informed that you can do these things.

To protect your rights, we need to make restrictions that forbid distributors to deny you these rights or to ask you to surrender these rights. These restrictions translate to certain responsibilities for you if you distribute copies of the library or if you modify it.

For example, if you distribute copies of the library, whether gratis or for a fee, you must give the recipients all the rights that we gave you. You must make sure that they, too, receive or can get the source code. If you link other code with the library, you must provide complete object files to the recipients, so that they can relink them with the library after making changes to the library and recompiling it. And you must show them these terms so they know their rights.

We protect your rights with a two-step method: (1) we copyright the library, and (2) we offer you this license, which gives you legal permission to copy, distribute and/or modify the library.

To protect each distributor, we want to make it very clear that there is no warranty for the free library. Also, if the library is modified by someone else and passed on, the recipients should know that what they have is not the original version, so that the original author's reputation will not be affected by problems that might be introduced by others.

Finally, software patents pose a constant threat to the existence of any free program. We wish to make sure that a company cannot effectively restrict the users of a free program by obtaining a restrictive license from a patent holder. Therefore, we insist that any patent license obtained for a version of the library must be consistent with the full freedom of use specified in this license.

Most GNU software, including some libraries, is covered by the ordinary GNU General Public License. This license, the GNU Lesser General Public License, applies to certain designated libraries, and is quite different from the ordinary General Public License. We use this license for certain libraries in order to permit linking those libraries into non-free programs.

When a program is linked with a library, whether statically or using a shared library, the combination of the two is legally speaking a combined work, a derivative of the original library. The ordinary General Public License therefore permits such linking only if the entire combination fits its criteria of freedom. The Lesser General Public License permits more lax criteria for linking other code with the library.

We call this license the "Lesser" General Public License because it does Less to protect the user's freedom than the ordinary General Public License. It also provides other free software developers Less of an advantage over competing non-free programs. These disadvantages are the reason we use the ordinary General Public License for many libraries. However, the Lesser license provides advantages in certain special circumstances.

For example, on rare occasions, there may be a special need to encourage the widest possible use of a certain library, so that it becomes a de-facto standard. To achieve this, non-free programs must be allowed to use the library. A more frequent case is that a free library does the same job as widely used non-free libraries. In this case, there is little to gain by limiting the free library to free software only, so we use the Lesser General Public License.

In other cases, permission to use a particular library in non-free programs enables a greater number of people to use a large body of free software. For example, permission to use the GNU C Library in non-free programs enables many more people to use the whole GNU operating system, as well as its variant, the GNU/Linux operating system.

Although the Lesser General Public License is Less protective of the users' freedom, it does ensure that the user of a program that is linked with the Library has the freedom and the wherewithal to run that program using a modified version of the Library.

The precise terms and conditions for copying, distribution and modification follow. Pay close attention to the difference between a "work based on the library" and a "work that uses the library". The former contains code derived from the library, whereas the latter must be combined with the library in order to run.

GNU LESSER GENERAL PUBLIC LICENSE TERMS AND CONDITIONS FOR COPYING, DISTRIBUTION AND MODIFICATION

0. This License Agreement applies to any software library or other program which contains a notice placed by the copyright holder or other authorized party saying it may be distributed under the terms of this Lesser General Public License (also called "this License"). Each licensee is addressed as "you".

A "library" means a collection of software functions and/or data prepared so as to be conveniently linked with application programs (which use some of those functions and data) to form executables.

The "Library", below, refers to any such software library or work which has been distributed under these terms. A "work based on theLibrary" means either the Library or any derivative work under copyright law: that is to say, a work containing the Library or a portion of it, either verbatim or with modifications and/or translated straightforwardly into another language. (Hereinafter, translation is included without limitation in the term "modification".)

"Source code" for a work means the preferred form of the work for making modifications to it. For a library, complete source code means all the source code for all modules it contains, plus any associated interface definition files, plus the scripts used to control compilation and installation of the library.

Activities other than copying, distribution and modification are not covered by this License; they are outside its scope. The act of running a program using the Library is not restricted, and output from such a program is covered only if its contents constitute a work based on the Library (independent of the use of the Library in a tool for writing it). Whether that is true depends on what the Library does and what the program that uses the Library does.

1. You may copy and distribute verbatim copies of the Library's complete source code as you receive it, in any medium, provided that you conspicuously and appropriately publish on each copy an appropriate copyright notice and disclaimer of warranty; keep intact all the notices that refer to this License and to the absence of any warranty; and distribute a copy of this License along with theLibrary.

You may charge a fee for the physical act of transferring a copy, and you may at your option offer warranty protection in exchange for a fee.

2. You may modify your copy or copies of the Library or any portion of it, thus forming a work based on the Library, and copy and distribute such modifications or work under the terms of Section 1 above, provided that you also meet all of these conditions:

a) The modified work must itself be a software library.

- b) You must cause the files modified to carry prominent notices stating that you changed the files and the date of any change.
- c) You must cause the whole of the work to be licensed at no charge to all third parties under the terms of this License.
- d) If a facility in the modified Library refers to a function or a table of data to be supplied by an application program that uses the facility, other than as an argument passed when the facility is invoked, then you must make a good faith effort to ensure that, in the event an application does not supply such function or table, the facility still operates, and performs whatever part of its purpose remains meaningful.

(For example, a function in a library to compute square roots has a purpose that is entirely well-defined independent of the application. Therefore, Subsection 2d requires that any application-supplied function or table used by this function must be optional: if the application does not supply it, the square root function must still compute square roots.) These requirements apply to the modified work as a whole. If identifiable sections of that work are not derived from the Library, and can be reasonably considered independent and separate works in themselves, then this License, and its terms, do not apply to those sections when you distribute them as separate works. But when you distribute the same sections as part of a whole which is a work based on the Library, the distribution of the whole must be on the terms of this License, whose permissions for other licensees extend to the entire whole, and thus to each and every part regardless of who wrote it.

Thus, it is not the intent of this section to claim rights or contest your rights to work written entirely by you; rather, the intent is to exercise the right to control the distribution of derivative or collective works based on the Library.

In addition, mere aggregation of another work not based on the Library with the Library (or with a work based on the Library) on a volume of a storage or distribution medium does not bring the other work under the scope of this License.

3. You may opt to apply the terms of the ordinary GNU General Public License instead of this License to a given copy of the Library. To do this, you must alter all the notices that refer to this License, so that they refer to the ordinary GNU General Public License, version 2, instead of to this License. (If a newer version than version 2 of the ordinary GNU General Public License has appeared, then you can specify that version instead if you wish.) Do not make any other change in these notices.

Once this change is made in a given copy, it is irreversible for that copy, so the ordinary GNU General Public License applies to all subsequent copies and derivative works made from that copy.

This option is useful when you wish to copy part of the code of the Library into a program that is not a library.

4. You may copy and distribute the Library (or a portion or derivative of it, under Section 2) in object code or executable form under the terms of Sections 1 and 2 above provided that you accompany it with the complete corresponding machine-readable source code, which must be distributed under the terms of Sections 1 and 2 above on a medium customarily used for software interchange.

If distribution of object code is made by offering access to copy from a designated place, then offering equivalent access to copy the source code from the same place satisfies the requirement to distribute the source code, even though third parties are not compelled to copy the source along with the object code.

5. A program that contains no derivative of any portion of the Library, but is designed to work with the Library by being compiled or linked with it, is called a "work that uses the Library". Such a work, in isolation, is not a derivative work of the Library, and therefore falls outside the scope of this License.

However, linking a "work that uses the Library" with the Library creates an executable that is a derivative of the Library (because it contains portions of the Library), rather than a "work that uses the library". The executable is therefore covered by this License. Section 6 states terms for distribution of such executables.

When a "work that uses the Library" uses material from a header file that is part of the Library, the object code for the work may be a derivative work of the Library even though the source code is not. Whether this is true is especially significant if the work can be linked without the Library, or if the work is itself a library. The threshold for this to be true is not precisely defined by law.

If such an object file uses only numerical parameters, data structure layouts and accessors, and small macros and small inline functions (ten lines or less in length), then the use of the object file is unrestricted, regardless of whether it is legally a derivative work. (Executables containing this object code plus portions of the Library will still fall under Section 6.) Otherwise, if the work is a derivative of the Library, you may distribute the object code for the work under the terms of Section 6. Any executables containing that work also fall under Section 6, whether or not they are linked directly with the Library itself.

6. As an exception to the Sections above, you may also combine or link a "work that uses the Library" with the Library to produce a work containing portions of the Library, and distribute that work under terms of your choice, provided that the terms permit modification of the work for the customer's own use and reverse engineering for debugging such modifications.

You must give prominent notice with each copy of the work that the Library is used in it and that the Library and its use are covered by this License. You must supply a copy of this License. If the work during execution displays copyright notices, you must include the copyright notice for the Library among them, as well as a reference directing the user to the copy of this License. Also, you must do one of these things:

a) Accompany the work with the complete corresponding machine-readable source code for the Library including whatever changes were used in the work (which must be distributed under Sections 1 and 2 above); and, if the work is an executable linked with the Library, with the complete machine-readable "work that uses the Library", as object code and/or source code, so that the user can modify the Library and then relink to produce a modified executable containing the modified Library. (It is understood that the user who changes the contents of definitions files in the Library will not necessarily be able to recompile the application to use the modified definitions.)

- b) Use a suitable shared library mechanism for linking with the Library. A suitable mechanism is one that (1) uses at run time a copy of the library already present on the user's computer system, rather than copying library functions into the executable, and (2) will operate properly with a modified version of the library, if the user installs one, as long as the modified version is interface-compatible with the version that the work was made with.
- c) Accompany the work with a written offer, valid for at least three years, to give the same user the materials specified in Subsection 6a, above, for a charge no more than the cost of performing this distribution.
- d) If distribution of the work is made by offering access to copy from a designated place, offer equivalent access to copy the above specified materials from the same place.
- e) Verify that the user has already received a copy of these materials or that you have already sent this user a copy.

For an executable, the required form of the "work that uses theLibrary" must include any data and utility programs needed for reproducing the executable from it. However, as a special exception, the materials to be distributed need not include anything that is normally distributed (in either source or binary form) with the major components (compiler, kernel, and so on) of the operating system on which the executable runs, unless that component itself accompanies the executable.

It may happen that this requirement contradicts the license restrictions of other proprietary libraries that do not normally accompany the operating system. Such a contradiction means you cannot use both them and the Library together in an executable that you distribute.

7. You may place library facilities that are a work based on the Library side-by-side in a single library together with other library facilities not covered by this License, and distribute such a combined library, provided that the separate distribution of the work based on the Library and of the other library facilities is otherwise permitted, and provided that you do these two things:

- a) Accompany the combined library with a copy of the same work based on the Library, uncombined with any other library facilities. This must be distributed under the terms of the Sections above.

b) Give prominent notice with the combined library of the fact that part of it is a work based on the Library, and explaining where to find the accompanying uncombined form of the same work.

8. You may not copy, modify, sublicense, link with, or distribute the Library except as expressly provided under this License. Any attempt otherwise to copy, modify, sublicense, link with, or distribute the Library is void, and will automatically terminate your rights under this License. However, parties who have received copies, or rights, from you under this License will not have their licenses terminated so long as such parties remain in full compliance.

9. You are not required to accept this License, since you have not signed it. However, nothing else grants you permission to modify or distribute the Library or its derivative works. These actions are prohibited by law if you do not accept this License. Therefore, by modifying or distributing the Library (or any work based on the Library), you indicate your acceptance of this License to do so, and all its terms and conditions for copying, distributing or modifying the Library or works based on it.

10. Each time you redistribute the Library (or any work based on the Library), the recipient automatically receives a license from the original licensor to copy, distribute, link with or modify the Library subject to these terms and conditions. You may not impose any further restrictions on the recipients' exercise of the rights granted herein. You are not responsible for enforcing compliance by third parties with this License.

11. If, as a consequence of a court judgment or allegation of patent infringement or for any other reason (not limited to patent issues), conditions are imposed on you (whether by court order, agreement or otherwise) that contradict the conditions of this License, they do not excuse you from the conditions of this License. If you cannot distribute so as to satisfy simultaneously your obligations under this License and any other pertinent obligations, then as a consequence you may not distribute the Library at all. For example, if a patent license would not permit royalty-free redistribution of the Library by all those who receive copies directly or indirectly through you, then the only way you could satisfy both it and this License would be to refrain entirely from distribution of the Library.

If any portion of this section is held invalid or unenforceable under any particular circumstance, the balance of the section is intended to apply, and the section as a whole is intended to apply in other circumstances.

It is not the purpose of this section to induce you to infringe any patents or other property right claims or to contest validity of any such claims; this section has the sole purpose of protecting the integrity of the free software distribution system which is implemented by public license practices.

Many people have made generous contributions to the wide range of software distributed through that system in reliance on consistent application of that system; it is up to the author/donor to decide if he or she is willing to distribute software through any other system and a licensee cannot impose that choice.

This section is intended to make thoroughly clear what is believed to be a consequence of the rest of this License.

12. If the distribution and/or use of the Library is restricted in certain countries either by patents or by copyrighted interfaces, the original copyright holder who places the Library under this License may add an explicit geographical distribution limitation excluding those countries, so that distribution is permitted only in or among countries not thus excluded. In such case, this License incorporates the limitation as if written in the body of this License.

13. The Free Software Foundation may publish revised and/or new versions of the Lesser General Public License from time to time. Such new versions will be similar in spirit to the present version, but may differ in detail to address new problems or concerns.

Each version is given a distinguishing version number. If the Library specifies a version number of this License which applies to it and "any later version", you have the option of following the terms and conditions either of that version or of any later version published by the Free Software Foundation. If the Library does not specify a license version number, you may choose any version ever published by the Free Software Foundation.

14. If you wish to incorporate parts of the Library into other free programs whose distribution conditions are incompatible with these, write to the author to ask for permission. For software which is copyrighted by the Free Software Foundation, write to the Free Software Foundation; we sometimes make exceptions for this. Our decision will be guided by the two goals of preserving the free status of all derivatives of our free software and of promoting the sharing and reuse of software generally.

NO WARRANTY

15. BECAUSE THE LIBRARY IS LICENSED FREE OF CHARGE, THERE IS NO WARRANTY FOR THE LIBRARY, TO THE EXTENT PERMITTED BY APPLICABLE LAW. EXCEPT WHEN OTHERWISE STATED IN WRITING THE COPYRIGHT HOLDERS AND/OR OTHER PARTIES PROVIDE THE LIBRARY "AS IS" WITHOUT WARRANTY OF ANY KIND, EITHER EXPRESSED OR IMPLIED, INCLUDING, BUT NOT LIMITED TO, THE IMPLIED WARRANTIES OF MERCHANTABILITY AND FITNESS FOR A PARTICULAR PURPOSE. THE ENTIRE RISK AS TO THE QUALITY AND PERFORMANCE OF THE LIBRARY IS WITH YOU. SHOULD THE LIBRARY PROVE DEFECTIVE, YOU ASSUME THE COST OF ALL NECESSARY SERVICING, REPAIR OR CORRECTION.

16. IN NO EVENT UNLESS REQUIRED BY APPLICABLE LAW OR AGREED TO IN WRITING WILL ANY COPYRIGHT HOLDER, OR ANY OTHER PARTY WHO MAY MODIFY AND/OR REDISTRIBUTE THE LIBRARY AS PERMITTED ABOVE, BE LIABLE TO YOU FOR DAMAGES, INCLUDING ANY GENERAL, SPECIAL, INCIDENTAL OR CONSEQUENTIAL DAMAGES ARISING OUT OF THE USE OR INABILITY TO USE THE LIBRARY (INCLUDING BUT NOT LIMITED TO LOSS OF DATA OR DATA BEING RENDERED INACCURATE OR LOSSES SUSTAINED BY YOU OR THIRD PARTIES OR A FAILURE OF THE LIBRARY TO OPERATE WITH ANY OTHER SOFTWARE), EVEN IF SUCH HOLDER OR OTHER PARTY HAS BEEN ADVISED OF THE POSSIBILITY OF SUCH DAMAGES.

END OF TERMS AND CONDITIONS

How to Apply These Terms to Your New Libraries

If you develop a new library, and you want it to be of the greatest possible use to the public, we recommend making it free software that everyone can redistribute and change. You can do so by permitting redistribution under these terms (or, alternatively, under the terms of the ordinary General Public License).

To apply these terms, attach the following notices to the library. It is safest to attach them to the start of each source file to most effectively convey the exclusion of warranty; and each file should have at least the "copyright" line and a pointer to where the full notice is found.

<one line to give the library's name and a brief idea of what it does.>
Copyright (C) <year> <name of author>

This library is free software; you can redistribute it and/or modify it under the terms of the GNU Lesser General Public License as published by the Free Software Foundation; either version 2.1 of the License, or (at your option) any later version.

This library is distributed in the hope that it will be useful, but WITHOUT ANY WARRANTY; without even the implied warranty of MERCHANTABILITY or FITNESS FOR A PARTICULAR PURPOSE. See the GNU Lesser General Public License for more details.

You should have received a copy of the GNU Lesser General Public License along with this library; if not, write to the Free Software Foundation, Inc., 51 Franklin Street, Fifth Floor, Boston, MA 02110-1301 USA Also add information on how to contact you by electronic and paper mail.

You should also get your employer (if you work as a programmer) or your school, if any, to sign a "copyright disclaimer" for the library, if necessary. Here is a sample; alter the names:

Yoyodyne, Inc., hereby disclaims all copyright interest in the library `Frob' (a library for tweaking knobs) written by James Random Hacker.

<signature of Ty Coon>, 1 April 1990 Ty Coon, President of Vice

That's all there is to it!

A.12.2 ICS DHCP

Copyright (c) 2004-2011 by Internet Systems Consortium, Inc. ("ISC")
Copyright (c) 1995-2003 by Internet Software Consortium

Permission to use, copy, modify, and distribute this software for any purpose with or without fee is hereby granted, provided that the above copyright notice and this permission notice appear in all copies.

THE SOFTWARE IS PROVIDED "AS IS" AND ISC DISCLAIMS ALL WARRANTIES WITH REGARD TO THIS SOFTWARE INCLUDING ALL IMPLIED WARRANTIES OF MERCHANTABILITY AND FITNESS. IN NO EVENT SHALL ISC BE LIABLE FOR ANY SPECIAL, DIRECT, INDIRECT, OR CONSEQUENTIAL DAMAGES OR ANY DAMAGES WHATSOEVER RESULTING FROM LOSS OF USE, DATA OR PROFITS, WHETHER IN AN ACTION OF CONTRACT, NEGLIGENCE OR OTHER TORTIOUS ACTION, ARISING OUT OF OR IN CONNECTION WITH THE USE OR PERFORMANCE OF THIS SOFTWARE.

A.12.3 curl

Copyright (c) 1996 - 2011, Daniel Stenberg, <daniel@haxx.se>.

All rights reserved.

Permission to use, copy, modify, and distribute this software for any purpose with or without fee is hereby granted, provided that the above copyright notice and this permission notice appear in all copies.

THE SOFTWARE IS PROVIDED "AS IS", WITHOUT WARRANTY OF ANY KIND, EXPRESS OR IMPLIED, INCLUDING BUT NOT LIMITED TO THE WARRANTIES OF MERCHANTABILITY, FITNESS FOR A PARTICULAR PURPOSE AND NONINFRINGEMENT OF THIRD PARTY RIGHTS. IN NO EVENT SHALL THE AUTHORS OR COPYRIGHT HOLDERS BE LIABLE FOR ANY CLAIM, DAMAGES OR OTHER LIABILITY, WHETHER IN AN ACTION OF CONTRACT, TORT OR OTHERWISE, ARISING FROM, OUT OF OR IN CONNECTION WITH THE SOFTWARE OR THE USE OR OTHER DEALINGS IN THE SOFTWARE.

Except as contained in this notice, the name of a copyright holder shall not be used in advertising or otherwise to promote the sale, use or other dealings in this Software without prior written authorization of the copyright holder.

A.12.4 expat

Copyright (c) 1998, 1999, 2000 Thai Open Source Software Center Ltd and Clark Cooper

Copyright (c) 2001, 2002, 2003, 2004, 2005, 2006 Expat maintainers.

Permission is hereby granted, free of charge, to any person obtaining a copy of this software and associated documentation files (the "Software"), to deal in the Software without restriction, including without limitation the rights to use, copy, modify, merge, publish, distribute, sublicense, and/or sell copies of the Software, and to permit persons to whom the Software is furnished to do so, subject to the following conditions:

The above copyright notice and this permission notice shall be included in all copies or substantial portions of the Software.

THE SOFTWARE IS PROVIDED "AS IS", WITHOUT WARRANTY OF ANY KIND, EXPRESS OR IMPLIED, INCLUDING BUT NOT LIMITED TO THE WARRANTIES OF MERCHANTABILITY, FITNESS FOR A PARTICULAR PURPOSE AND NONINFRINGEMENT. IN NO EVENT SHALL THE AUTHORS OR COPYRIGHT HOLDERS BE LIABLE FOR ANY CLAIM, DAMAGES OR OTHER LIABILITY, WHETHER IN AN ACTION OF CONTRACT, TORT OR OTHERWISE, ARISING FROM, OUT OF OR IN CONNECTION WITH THE SOFTWARE OR THE USE OR OTHER DEALINGS IN THE SOFTWARE

A.12.5 libevent

Copyright (c) 2000-2007 Niels Provos <provos@citi.umich.edu>

Copyright (c) 2007-2010 Niels Provos and Nick Mathewson

Redistribution and use in source and binary forms, with or without modification, are permitted provided that the following conditions are met:

1. Redistributions of source code must retain the above copyright notice, this list of conditions and the following disclaimer.
2. Redistributions in binary form must reproduce the above copyright notice, this list of conditions and the following disclaimer in the documentation and/or other materials provided with the distribution.
3. The name of the author may not be used to endorse or promote products derived from this software without specific prior written permission.

THIS SOFTWARE IS PROVIDED BY THE AUTHOR "AS IS" AND ANY EXPRESS OR IMPLIED WARRANTIES, INCLUDING, BUT NOT LIMITED TO, THE IMPLIED WARRANTIES OF MERCHANTABILITY AND FITNESS FOR A PARTICULAR PURPOSE ARE DISCLAIMED.

IN NO EVENT SHALL THE AUTHOR BE LIABLE FOR ANY DIRECT, INDIRECT, INCIDENTAL, SPECIAL, EXEMPLARY, OR CONSEQUENTIAL DAMAGES (INCLUDING, BUT NOT LIMITED TO, PROCUREMENT OF SUBSTITUTE GOODS OR SERVICES; LOSS OF USE, DATA, OR PROFITS; OR BUSINESS INTERRUPTION) HOWEVER CAUSED AND ON ANY THEORY OF LIABILITY, WHETHER IN CONTRACT, STRICT LIABILITY, OR TORT (INCLUDING NEGLIGENCE OR OTHERWISE) ARISING IN ANY WAY OUT OF THE USE OF THIS SOFTWARE, EVEN IF ADVISED OF THE POSSIBILITY OF SUCH DAMAGE.

Portions of Libevent are based on works by others, also made available by them under the three-clause BSD license above. The copyright notices are available in the corresponding source files; the license is as above. Here's a list:

log.c: Copyright (c) 2000 Dug Song <dugsong@monkey.org> Copyright (c) 1993 The Regents of the University of California.

strlcpy.c: Copyright (c) 1998 Todd C. Miller <Todd.Miller@courtesan.com>

win32select.c: Copyright (c) 2003 Michael A. Davis <mike@datanerds.net>

evport.c: Copyright (c) 2007 Sun Microsystems

ht-internal.h: Copyright (c) 2002 Christopher Clark

minheap-internal.h: Copyright (c) 2006 Maxim Yegorushkin <maxim.yegorushkin@gmail.com>

The arc4module is available under the following license:

Copyright (c) 1996, David Mazieres <dm@uun.org>
Copyright (c) 2008, Damien Miller <djm@openbsd.org>

Permission to use, copy, modify, and distribute this software for any purpose with or without fee is hereby granted, provided that the above copyright notice and this permission notice appear in all copies.

THE SOFTWARE IS PROVIDED "AS IS" AND THE AUTHOR DISCLAIMS ALL WARRANTIES WITH REGARD TO THIS SOFTWARE INCLUDING ALL IMPLIED WARRANTIES OF MERCHANTABILITY AND FITNESS. IN NO EVENT SHALL THE AUTHOR BE LIABLE FOR ANY SPECIAL, DIRECT, INDIRECT, OR CONSEQUENTIAL DAMAGES OR ANY DAMAGES WHATSOEVER RESULTING FROM LOSS OF USE, DATA OR PROFITS, WHETHER IN AN ACTION OF CONTRACT, NEGLIGENCE OR OTHER TORTIOUS ACTION, ARISING OUT OF OR IN CONNECTION WITH THE USE OR PERFORMANCE OF THIS SOFTWARE.

A.12.6 json-c

Copyright (c) 2004, 2005 Metaparadigm Pte Ltd

Permission is hereby granted, free of charge, to any person obtaining a copy of this software and associated documentation files (the "Software"), to deal in the Software without restriction, including without limitation the rights to use, copy, modify, merge, publish, distribute, sublicense, and/or sell copies of the Software, and to permit persons to whom the Software is furnished to do so, subject to the following conditions:

The above copyright notice and this permission notice shall be included in all copies or substantial portions of the Software.

THE SOFTWARE IS PROVIDED "AS IS", WITHOUT WARRANTY OF ANY KIND, EXPRESS OR IMPLIED, INCLUDING BUT NOT LIMITED TO THE WARRANTIES OF MERCHANTABILITY, FITNESS FOR A PARTICULAR PURPOSE AND NONINFRINGEMENT. IN NO EVENT SHALL THE AUTHORS OR COPYRIGHT HOLDERS BE LIABLE FOR ANY CLAIM, DAMAGES OR OTHER LIABILITY, WHETHER IN AN ACTION OF CONTRACT, TORT OR OTHERWISE, ARISING FROM, OUT OF OR IN CONNECTION WITH THE SOFTWARE OR THE USE OR OTHER DEALINGS IN THE SOFTWARE.

A.12.7 LUA

Copyright (C) 1994-2008 Lua.org, PUC-Rio.

Permission is hereby granted, free of charge, to any person obtaining a copy of this software and associated documentation files (the "Software"), to deal in the Software without restriction, including without limitation the rights to use, copy, modify, merge, publish, distribute, sublicense, and/or sell copies of the Software, and to permit persons to whom the Software is furnished to do so, subject to the following conditions:

The above copyright notice and this permission notice shall be included in all copies or substantial portions of the Software.

THE SOFTWARE IS PROVIDED "AS IS", WITHOUT WARRANTY OF ANY KIND, EXPRESS OR IMPLIED, INCLUDING BUT NOT LIMITED TO THE WARRANTIES OF MERCHANTABILITY, FITNESS FOR A PARTICULAR PURPOSE AND NONINFRINGEMENT. IN NO EVENT SHALL THE AUTHORS OR COPYRIGHT HOLDERS BE LIABLE FOR ANY CLAIM, DAMAGES OR OTHER LIABILITY, WHETHER IN AN ACTION OF CONTRACT, TORT OR OTHERWISE, ARISING FROM, OUT OF OR IN CONNECTION WITH THE SOFTWARE OR THE USE OR OTHER DEALINGS IN THE SOFTWARE.

A.12.8 sprintf.js

Copyright (c) 2007-2013, Alexandru Marasteanu <hello [at] alexei (dot) ro>All rights reserved.

Redistribution and use in source and binary forms, with or without modification, are permitted provided that the following conditions are met:

- * Redistributions of source code must retain the above copyright notice, this list of conditions and the following disclaimer.
- * Redistributions in binary form must reproduce the above copyright notice, this list of conditions and the following disclaimer in the documentation and/or other materials provided with the distribution.
- * Neither the name of this software nor the names of its contributors may be used to endorse or promote products derived from this software without specific prior written permission.

THIS SOFTWARE IS PROVIDED BY THE COPYRIGHT HOLDERS AND CONTRIBUTORS "AS IS" AND ANY EXPRESS OR IMPLIED WARRANTIES, INCLUDING, BUT NOT LIMITED TO, THE IMPLIED WARRANTIES OF MERCHANTABILITY AND FITNESS FOR A PARTICULAR PURPOSE ARE DISCLAIMED. IN NO EVENT SHALL THE AUTHORS OR COPYRIGHT HOLDERS BE LIABLE FOR ANY DIRECT, INDIRECT, INCIDENTAL, SPECIAL, EXEMPLARY, OR CONSEQUENTIAL DAMAGES (INCLUDING, BUT NOT LIMITED TO, PROCUREMENT OF SUBSTITUTE GOODS OR SERVICES; LOSS OF USE, DATA, OR PROFITS; OR BUSINESS INTERRUPTION) HOWEVER CAUSED AND ON ANY THEORY OF LIABILITY, WHETHER IN CONTRACT, STRICT LIABILITY, OR TORT (INCLUDING NEGLIGENCE OR OTHERWISE) ARISING IN ANY WAY OUT OF THE USE OF THIS SOFTWARE, EVEN IF ADVISED OF THE POSSIBILITY OF SUCH DAMAGE.

A.12.9 Flexigrid

Copyright (c) 2008 Paulo P. Marinas

Permission is hereby granted, free of charge, to any person obtaining a copy of this software and associated documentation files (the "Software"), to deal in the Software without restriction, including without limitation the rights to use, copy, modify, merge, publish, distribute, sublicense, and/or sell copies of the Software, and to permit persons to whom the Software is furnished to do so, subject to the following conditions:

The above copyright notice and this permission notice shall be included in all copies or substantial portions of the Software.

THE SOFTWARE IS PROVIDED "AS IS", WITHOUT WARRANTY OF ANY KIND, EXPRESS OR IMPLIED, INCLUDING BUT NOT LIMITED TO THE WARRANTIES OF MERCHANTABILITY, FITNESS FOR A PARTICULAR PURPOSE AND NONINFRINGEMENT. IN NO EVENT SHALL THE AUTHORS OR COPYRIGHT HOLDERS BE LIABLE FOR ANY CLAIM, DAMAGES OR OTHER LIABILITY, WHETHER IN AN ACTION OF CONTRACT, TORT OR OTHERWISE, ARISING FROM, OUT OF OR IN CONNECTION WITH THE SOFTWARE OR THE USE OR OTHER DEALINGS IN THE SOFTWARE.

A.12.10 jquery

Copyright (c) 2005, 2014 jQuery Foundation, Inc

Permission is hereby granted, free of charge, to any person obtaining a copy of this software and associated documentation files (the "Software"), to deal in the Software without restriction, including without limitation the right to use, copy, modify, merge, publish, distribute, sublicense, and/or sell copies of the Software, and to permit persons to whom the Software is furnished to do so, subject to the following conditions:

The above copyright notice and this permission notice shall be included in all copies or substantial portions of the Software.

THE SOFTWARE IS PROVIDED "AS IS", WITHOUT WARRANTY OF ANY KIND, EXPRESS OR IMPLIED, INCLUDING BUT NOT LIMITED TO THE WARRANTIES OF MERCHANTABILITY, FITNESS FOR A PARTICULAR PURPOSE AND NONINFRINGEMENT. IN NO EVENT SHALL THE AUTHORS OR COPYRIGHT HOLDERS BE LIABLE FOR ANY CLAIM, DAMAGES OR OTHER LIABILITY, WHETHER IN AN ACTION OF CONTRACT, TORT OR OTHERWISE, ARISING FROM, OUT OF OR IN CONNECTION WITH THE SOFTWARE OR THE USE OR OTHER DEALINGS IN THE SOFTWARE.

A.12.11 mootools, mootools-more

Copyright (c) 2006-2014 Valerio Proietti, <<http://mad4milk.net/>>

Permission is hereby granted, free of charge, to any person obtaining a copy of this software and associated documentation files (the "Software"), to deal in the Software without restriction, including without limitation the right to use, copy, modify, merge, publish, distribute, sublicense, and/or sell copies of the Software, and to permit persons to whom the Software is furnished to do so, subject to the following conditions:

The above copyright notice and this permission notice shall be included in all copies or substantial portions of the Software.

THE SOFTWARE IS PROVIDED "AS IS", WITHOUT WARRANTY OF ANY KIND, EXPRESS OR IMPLIED, INCLUDING BUT NOT LIMITED TO THE WARRANTIES OF MERCHANTABILITY, FITNESS FOR A PARTICULAR PURPOSE AND NONINFRINGEMENT. IN NO EVENT SHALL THE AUTHORS OR COPYRIGHT HOLDERS BE LIABLE FOR ANY CLAIM, DAMAGES OR OTHER LIABILITY, WHETHER IN AN ACTION OF CONTRACT, TORT OR OTHERWISE, ARISING FROM, OUT OF OR IN CONNECTION WITH THE SOFTWARE OR THE USE OR OTHER DEALINGS IN THE SOFTWARE.

A.12.12 NetSNMP

Various copyrights apply to this package, listed in various separate parts below. Please make sure that you read all the parts.

---- Part 1: CMU/UCD copyright notice: (BSD like) ----

Copyright 1989, 1991, 1992 by Carnegie Mellon University

Derivative Work - 1996, 1998-2000 Copyright 1996, 1998-2000
The Regents of the University of California

All Rights Reserved

Permission to use, copy, modify and distribute this software and its documentation for any purpose and without fee is hereby granted, provided that the above copyright notice appears in all copies and that both that copyright notice and this permission notice appear in supporting documentation, and that the name of CMU and The Regents of the University of California not be used in advertising or publicity pertaining to distribution of the software without specific written permission.

CMU AND THE REGENTS OF THE UNIVERSITY OF CALIFORNIA DISCLAIM ALL WARRANTIES WITH REGARD TO THIS SOFTWARE, INCLUDING ALL IMPLIED WARRANTIES OF MERCHANTABILITY AND FITNESS. IN NO EVENT SHALL CMU OR THE REGENTS OF THE UNIVERSITY OF CALIFORNIA BE LIABLE FOR ANY SPECIAL, INDIRECT OR CONSEQUENTIAL DAMAGES OR ANY DAMAGES WHATSOEVER RESULTING FROM THE LOSS OF USE, DATA OR PROFITS, WHETHER IN AN ACTION OF CONTRACT, NEGLIGENCE OR OTHER TORTIOUS ACTION, ARISING OUT OF OR IN CONNECTION WITH THE USE OR PERFORMANCE OF THIS SOFTWARE.

---- Part 2: Networks Associates Technology, Inc copyright notice (BSD) ----

Copyright (c) 2001-2003, Networks Associates Technology, Inc
All rights reserved.

Redistribution and use in source and binary forms, with or without modification, are permitted provided that the following conditions are met:

* Redistributions of source code must retain the above copyright notice, this list of conditions and the following disclaimer.

- * Redistributions in binary form must reproduce the above copyright notice, this list of conditions and the following disclaimer in the documentation and/or other materials provided with the distribution.
- * Neither the name of the Networks Associates Technology, Inc nor the names of its contributors may be used to endorse or promote products derived from this software without specific prior written permission.

THIS SOFTWARE IS PROVIDED BY THE COPYRIGHT HOLDERS AND CONTRIBUTORS "AS IS" AND ANY EXPRESS OR IMPLIED WARRANTIES, INCLUDING, BUT NOT LIMITED TO, THE IMPLIED WARRANTIES OF MERCHANTABILITY AND FITNESS FOR A PARTICULAR PURPOSE ARE DISCLAIMED. IN NO EVENT SHALL THE COPYRIGHT HOLDERS OR CONTRIBUTORS BE LIABLE FOR ANY DIRECT, INDIRECT, INCIDENTAL, SPECIAL, EXEMPLARY, OR CONSEQUENTIAL DAMAGES (INCLUDING, BUT NOT LIMITED TO, PROCUREMENT OF SUBSTITUTE GOODS OR SERVICES; LOSS OF USE, DATA, OR PROFITS; OR BUSINESS INTERRUPTION) HOWEVER CAUSED AND ON ANY THEORY OF LIABILITY, WHETHER IN CONTRACT, STRICT LIABILITY, OR TORT (INCLUDING NEGLIGENCE OR OTHERWISE) ARISING IN ANY WAY OUT OF THE USE OF THIS SOFTWARE, EVEN IF ADVISED OF THE POSSIBILITY OF SUCH DAMAGE.

---- Part 3: Cambridge Broadband Ltd. copyright notice (BSD) ----

Portions of this code are copyright (c) 2001-2003, Cambridge Broadband Ltd.
All rights reserved.

Redistribution and use in source and binary forms, with or without modification, are permitted provided that the following conditions are met:

- * Redistributions of source code must retain the above copyright notice, this list of conditions and the following disclaimer.
 - * Redistributions in binary form must reproduce the above copyright notice, this list of conditions and the following disclaimer in the documentation and/or other materials provided with the distribution.
- * The name of Cambridge Broadband Ltd. may not be used to endorse or promote products derived from this software without specific prior written permission.

THIS SOFTWARE IS PROVIDED BY THE COPYRIGHT HOLDER ``AS IS" AND ANY EXPRESS OR IMPLIED WARRANTIES, INCLUDING, BUT NOT LIMITED TO, THE IMPLIED WARRANTIES OF MERCHANTABILITY AND FITNESS FOR A PARTICULAR PURPOSE ARE DISCLAIMED. IN NO EVENT SHALL THE COPYRIGHT HOLDER BE LIABLE FOR ANY DIRECT, INDIRECT, INCIDENTAL, SPECIAL, EXEMPLARY, OR CONSEQUENTIAL DAMAGES (INCLUDING, BUT NOT LIMITED TO, PROCUREMENT OF SUBSTITUTE GOODS OR SERVICES; LOSS OF USE, DATA, OR PROFITS; OR BUSINESS INTERRUPTION) HOWEVER CAUSED AND ON ANY THEORY OF LIABILITY, WHETHER IN CONTRACT, STRICT LIABILITY, OR TORT (INCLUDING NEGLIGENCE OR OTHERWISE) ARISING IN ANY WAY OUT OF THE USE OF THIS SOFTWARE, EVEN IF ADVISED OF THE POSSIBILITY OF SUCH DAMAGE.

---- Part 4: Sun Microsystems, Inc. copyright notice (BSD) ----

Copyright © 2003 Sun Microsystems, Inc., 4150 Network Circle, Santa Clara, California 95054, U.S.A. All rights reserved.

Use is subject to license terms below.

This distribution may include materials developed by third parties.

Sun, Sun Microsystems, the Sun logo and Solaris are trademarks or registered trademarks of Sun Microsystems, Inc. in the U.S. and other countries.

Redistribution and use in source and binary forms, with or without modification, are permitted provided that the following conditions are met:

- * Redistributions of source code must retain the above copyright notice, this list of conditions and the following disclaimer.
- * Redistributions in binary form must reproduce the above copyright notice, this list of conditions and the following disclaimer in the documentation and/or other materials provided with the distribution.
- * Neither the name of the Sun Microsystems, Inc. nor the names of its contributors may be used to endorse or promote products derived from this software without specific prior written permission.

THIS SOFTWARE IS PROVIDED BY THE COPYRIGHT HOLDERS AND CONTRIBUTORS ``AS IS" AND ANY EXPRESS OR IMPLIED WARRANTIES, INCLUDING, BUT NOT LIMITED TO, THE IMPLIED WARRANTIES OF MERCHANTABILITY AND FITNESS FOR A PARTICULAR PURPOSE ARE DISCLAIMED. IN NO EVENT SHALL THE COPYRIGHT HOLDERS OR CONTRIBUTORS BE LIABLE FOR ANY DIRECT, INDIRECT, INCI-

DENTAL, SPECIAL, EXEMPLARY, OR CONSEQUENTIAL DAMAGES (INCLUDING, BUT NOT LIMITED TO, PROCUREMENT OF SUBSTITUTE GOODS OR SERVICES; LOSS OF USE, DATA, OR PROFITS; OR BUSINESS INTERRUPTION) HOWEVER CAUSED AND ON ANY THEORY OF LIABILITY, WHETHER IN CONTRACT, STRICT LIABILITY, OR TORT (INCLUDING NEGLIGENCE OR OTHERWISE) ARISING IN ANY WAY OUT OF THE USE OF THIS SOFTWARE, EVEN IF ADVISED OF THE POSSIBILITY OF SUCH DAMAGE.

---- Part 5: Sparta, Inc copyright notice (BSD) ----

Copyright (c) 2003-2011, Sparta, Inc
All rights reserved.

Redistribution and use in source and binary forms, with or without modification, are permitted provided that the following conditions are met:

- * Redistributions of source code must retain the above copyright notice, this list of conditions and the following disclaimer.
- * Redistributions in binary form must reproduce the above copyright notice, this list of conditions and the following disclaimer in the documentation and/or other materials provided with the distribution.
- * Neither the name of Sparta, Inc nor the names of its contributors may be used to endorse or promote products derived from this software without specific prior written permission.

THIS SOFTWARE IS PROVIDED BY THE COPYRIGHT HOLDERS AND CONTRIBUTORS ``AS IS" AND ANY EXPRESS OR IMPLIED WARRANTIES, INCLUDING, BUT NOT LIMITED TO, THE IMPLIED WARRANTIES OF MERCHANTABILITY AND FITNESS FOR A PARTICULAR PURPOSE ARE DISCLAIMED. IN NO EVENT SHALL THE COPYRIGHT HOLDERS OR CONTRIBUTORS BE LIABLE FOR ANY DIRECT, INDIRECT, INCIDENTAL, SPECIAL, EXEMPLARY, OR CONSEQUENTIAL DAMAGES (INCLUDING, BUT NOT LIMITED TO, PROCUREMENT OF SUBSTITUTE GOODS OR SERVICES; LOSS OF USE, DATA, OR PROFITS; OR BUSINESS INTERRUPTION) HOWEVER CAUSED AND ON ANY THEORY OF LIABILITY, WHETHER IN CONTRACT, STRICT LIABILITY, OR TORT (INCLUDING NEGLIGENCE OR OTHERWISE) ARISING IN ANY WAY OUT OF THE USE OF THIS SOFTWARE, EVEN IF ADVISED OF THE POSSIBILITY OF SUCH DAMAGE.

---- Part 6: Cisco/BUPTNIC copyright notice (BSD) ----

Copyright (c) 2004, Cisco, Inc and Information Network Center of Beijing University of Posts and Telecommunications. All rights reserved.

Redistribution and use in source and binary forms, with or without modification, are permitted provided that the following conditions are met:

- * Redistributions of source code must retain the above copyright notice, this list of conditions and the following disclaimer.
- * Redistributions in binary form must reproduce the above copyright notice, this list of conditions and the following disclaimer in the documentation and/or other materials provided with the distribution.
- * Neither the name of Cisco, Inc, Beijing University of Posts and Telecommunications, nor the names of their contributors may be used to endorse or promote products derived from this software without specific prior written permission.

THIS SOFTWARE IS PROVIDED BY THE COPYRIGHT HOLDERS AND CONTRIBUTORS "AS IS" AND ANY EXPRESS OR IMPLIED WARRANTIES, INCLUDING, BUT NOT LIMITED TO, THE IMPLIED WARRANTIES OF MERCHANTABILITY AND FITNESS FOR A PARTICULAR PURPOSE ARE DISCLAIMED. IN NO EVENT SHALL THE COPYRIGHT HOLDERS OR CONTRIBUTORS BE LIABLE FOR ANY DIRECT, INDIRECT, INCIDENTAL, SPECIAL, EXEMPLARY, OR CONSEQUENTIAL DAMAGES (INCLUDING, BUT NOT LIMITED TO, PROCUREMENT OF SUBSTITUTE GOODS OR SERVICES; LOSS OF USE, DATA, OR PROFITS; OR BUSINESS INTERRUPTION) HOWEVER CAUSED AND ON ANY THEORY OF LIABILITY, WHETHER IN CONTRACT, STRICT LIABILITY, OR TORT (INCLUDING NEGLIGENCE OR OTHERWISE) ARISING IN ANY WAY OUT OF THE USE OF THIS SOFTWARE, EVEN IF ADVISED OF THE POSSIBILITY OF SUCH DAMAGE.

---- Part 7: Fabasoft R&D Software GmbH & Co KG copyright notice (BSD) -

Copyright (c) Fabasoft R&D Software GmbH & Co KG, 2003
oss@fabasoft.com Author: Bernhard Penz <bernhard.penz@fabasoft.com>

Redistribution and use in source and binary forms, with or without modification, are permitted provided that the following conditions are met:

- * Redistributions of source code must retain the above copyright notice, this list of conditions and the following disclaimer.
- * Redistributions in binary form must reproduce the above copyright notice, this list of conditions and the following disclaimer in the documentation and/or other materials provided with the distribution.
- * The name of Fabasoft R&D Software GmbH & Co KG or any of its subsidiaries, brand or product names may not be used to endorse or promote products derived from this software without specific prior written permission.

THIS SOFTWARE IS PROVIDED BY THE COPYRIGHT HOLDER ``AS IS" AND ANY EXPRESS OR IMPLIED WARRANTIES, INCLUDING, BUT NOT LIMITED TO, THE IMPLIED WARRANTIES OF MERCHANTABILITY AND FITNESS FOR A PARTICULAR PURPOSE ARE DISCLAIMED.

IN NO EVENT SHALL THE COPYRIGHT HOLDER BE LIABLE FOR ANY DIRECT, INDIRECT, INCIDENTAL, SPECIAL, EXEMPLARY, OR CONSEQUENTIAL DAMAGES (INCLUDING, BUT NOT LIMITED TO, PROCUREMENT OF SUBSTITUTE GOODS OR SERVICES; LOSS OF USE, DATA, OR PROFITS; OR BUSINESS INTERRUPTION) HOWEVER CAUSED AND ON ANY THEORY OF LIABILITY, WHETHER IN CONTRACT, STRICT LIABILITY, OR TORT (INCLUDING NEGLIGENCE OR OTHERWISE) ARISING IN ANY WAY OUT OF THE USE OF THIS SOFTWARE, EVEN IF ADVISED OF THE POSSIBILITY OF SUCH DAMAGE.

---- Part 8: Apple Inc. copyright notice (BSD) ----

Copyright (c) 2007 Apple Inc. All rights reserved.

Redistribution and use in source and binary forms, with or without modification, are permitted provided that the following conditions are met:

1. Redistributions of source code must retain the above copyright notice, this list of conditions and the following disclaimer.
2. Redistributions in binary form must reproduce the above copyright notice, this list of conditions and the following disclaimer in the documentation and/or other materials provided with the distribution.
3. Neither the name of Apple Inc. ("Apple") nor the names of its contributors may be used to endorse or promote products derived from this software without specific prior written permission.

THIS SOFTWARE IS PROVIDED BY APPLE AND ITS CONTRIBUTORS "AS IS" AND ANY EXPRESS OR IMPLIED WARRANTIES, INCLUDING, BUT NOT LIMITED TO, THE IMPLIED WARRANTIES OF MERCHANTABILITY AND FITNESS FOR A PARTICULAR PURPOSE ARE DISCLAIMED. IN NO EVENT SHALL APPLE OR ITS CONTRIBUTORS BE LIABLE FOR ANY DIRECT, INDIRECT, INCIDENTAL, SPECIAL, EXEMPLARY, OR CONSEQUENTIAL DAMAGES (INCLUDING, BUT NOT LIMITED TO, PROCUREMENT OF SUBSTITUTE GOODS OR SERVICES; LOSS OF USE, DATA, OR PROFITS; OR BUSINESS INTERRUPTION) HOWEVER CAUSED AND ON ANY THEORY OF LIABILITY, WHETHER IN CONTRACT, STRICT LIABILITY, OR TORT (INCLUDING NEGLIGENCE OR OTHERWISE) ARISING IN ANY WAY OUT OF THE USE OF THIS SOFTWARE, EVEN IF ADVISED OF THE POSSIBILITY OF SUCH DAMAGE.

---- Part 9: ScienceLogic, LLC copyright notice (BSD) ----

Copyright (c) 2009, ScienceLogic, LLC
All rights reserved.

Redistribution and use in source and binary forms, with or without modification, are permitted provided that the following conditions are met:

- * Redistributions of source code must retain the above copyright notice, this list of conditions and the following disclaimer.
- * Redistributions in binary form must reproduce the above copyright notice, this list of conditions and the following disclaimer in the documentation and/or other materials provided with the distribution.
- * Neither the name of ScienceLogic, LLC nor the names of its contributors may be used to endorse or promote products derived from this software without specific prior written permission.

THIS SOFTWARE IS PROVIDED BY THE COPYRIGHT HOLDERS AND CONTRIBUTORS "AS IS" AND ANY EXPRESS OR IMPLIED WARRANTIES, INCLUDING, BUT NOT LIMITED TO, THE IMPLIED WARRANTIES OF MERCHANTABILITY AND FITNESS FOR A PARTICULAR PURPOSE ARE DISCLAIMED. IN NO EVENT SHALL THE COPYRIGHT HOLDERS OR CONTRIBUTORS BE LIABLE FOR ANY DIRECT, INDIRECT, INCIDENTAL, SPECIAL, EXEMPLARY, OR CONSEQUENTIAL DAMAGES

(INCLUDING, BUT NOT LIMITED TO, PROCUREMENT OF SUBSTITUTE GOODS OR SERVICES; LOSS OF USE, DATA, OR PROFITS; OR BUSINESS INTERRUPTION) HOWEVER CAUSED AND ON ANY THEORY OF LIABILITY, WHETHER IN CONTRACT, STRICT LIABILITY, OR TORT (INCLUDING NEGLIGENCE OR OTHERWISE) ARISING IN ANY WAY OUT OF THE USE OF THIS SOFTWARE, EVEN IF ADVISED OF THE POSSIBILITY OF SUCH DAMAGE.

A.12.13 openssl

```
OpenSSL License ----- /*
=====
=====
```

- * Copyright (c) 1998-2011 The OpenSSL Project. All rights reserved.
- *
- * Redistribution and use in source and binary forms, with or without
- * modification, are permitted provided that the following conditions
- * are met:
- *
- * 1. Redistributions of source code must retain the above copyright
- * notice, this list of conditions and the following disclaimer.
- *
- * 2. Redistributions in binary form must reproduce the above copyright
- * notice, this list of conditions and the following disclaimer in
- * the documentation and/or other materials provided with the
- * distribution.
- *
- * 3. All advertising materials mentioning features or use of this
- * software must display the following acknowledgment:
- * "This product includes software developed by the OpenSSL Project
- * for use in the OpenSSL Toolkit. (<http://www.openssl.org/>)"
- *
- * 4. The names "OpenSSL Toolkit" and "OpenSSL Project" must not be used
- to
- * endorse or promote products derived from this software without

* prior written permission. For written permission, please contact
 * openssl-core@openssl.org.
 *

* 5. Products derived from this software may not be called "OpenSSL"
 * nor may "OpenSSL" appear in their names without prior written
 * permission of the OpenSSL Project.
 *

* 6. Redistributions of any form whatsoever must retain the following
 * acknowledgment:
 * "This product includes software developed by the OpenSSL Project
 * for use in the OpenSSL Toolkit (<http://www.openssl.org/>)"
 *

* THIS SOFTWARE IS PROVIDED BY THE OpenSSL PROJECT ``AS IS"
 AND ANY
 * EXPRESSED OR IMPLIED WARRANTIES, INCLUDING, BUT NOT LIM-
 ITED TO, THE
 * IMPLIED WARRANTIES OF MERCHANTABILITY AND FITNESS FOR A
 PARTICULAR
 * PURPOSE ARE DISCLAIMED. IN NO EVENT SHALL THE OpenSSL
 PROJECT OR
 * ITS CONTRIBUTORS BE LIABLE FOR ANY DIRECT, INDIRECT, INCI-
 DENTAL,
 * SPECIAL, EXEMPLARY, OR CONSEQUENTIAL DAMAGES (INCLU-
 DING, BUT
 * NOT LIMITED TO, PROCUREMENT OF SUBSTITUTE GOODS OR SER-
 VICES;
 * LOSS OF USE, DATA, OR PROFITS; OR BUSINESS INTERRUPTION)
 * HOWEVER CAUSED AND ON ANY THEORY OF LIABILITY, WHETHER
 IN CONTRACT,
 * STRICT LIABILITY, OR TORT (INCLUDING NEGLIGENCE OR OTHER-
 WISE)
 * ARISING IN ANY WAY OUT OF THE USE OF THIS SOFTWARE, EVEN
 IF ADVISED
 * OF THE POSSIBILITY OF SUCH DAMAGE.
 *

=====
 =====
 *
 * This product includes cryptographic software written by Eric Young
 * (eay@cryptsoft.com). This product includes software written by Tim
 * Hudson (tjh@cryptsoft.com).
 *

*/

Original SSLeay License

```
-----
/* Copyright (C) 1995-1998 Eric Young (eay@cryptsoft.com)
 * All rights reserved.
 *
 * This package is an SSL implementation written
 * by Eric Young (eay@cryptsoft.com).
 * The implementation was written so as to conform with Netscapes SSL.
 *
 * This library is free for commercial and non-commercial use as long as
 * the following conditions are aheared to. The following conditions
 * apply to all code found in this distribution, be it the RC4, RSA,
 * lhash, DES, etc., code; not just the SSL code. The SSL documentation
 * included with this distribution is covered by the same copyright terms
 * except that the holder is Tim Hudson (tjh@cryptsoft.com).
 *
 * Copyright remains Eric Young's, and as such any Copyright notices in
 * the code are not to be removed.
 * If this package is used in a product, Eric Young should be given attribution
 * as the author of the parts of the library used.
 * This can be in the form of a textual message at program startup or
 * in documentation (online or textual) provided with the package.
 *
 * Redistribution and use in source and binary forms, with or without
 * modification, are permitted provided that the following conditions
 * are met:
 * 1. Redistributions of source code must retain the copyright
 * notice, this list of conditions and the following disclaimer.
 * 2. Redistributions in binary form must reproduce the above copyright
 * notice, this list of conditions and the following disclaimer in the
 * documentation and/or other materials provided with the distribution.
 * 3. All advertising materials mentioning features or use of this software
 * must display the following acknowledgement:
 * "This product includes cryptographic software written by
 * Eric Young (eay@cryptsoft.com)"
 * The word 'cryptographic' can be left out if the rouines from the library
 * being used are not cryptographic related :-).
 * 4. If you include any Windows specific code (or a derivative thereof) from
 * the apps directory (application code) you must include an acknowledge-
 * ment:
```

* "This product includes software written by Tim Hudson (tjh@crypt-soft.com)"
 *
 * THIS SOFTWARE IS PROVIDED BY ERIC YOUNG ``AS IS" AND
 * ANY EXPRESS OR IMPLIED WARRANTIES, INCLUDING, BUT NOT LIMITED TO, THE
 * IMPLIED WARRANTIES OF MERCHANTABILITY AND FITNESS FOR A PARTICULAR PURPOSE
 * ARE DISCLAIMED. IN NO EVENT SHALL THE AUTHOR OR CONTRIBUTORS BE LIABLE
 * FOR ANY DIRECT, INDIRECT, INCIDENTAL, SPECIAL, EXEMPLARY, OR CONSEQUENTIAL
 * DAMAGES (INCLUDING, BUT NOT LIMITED TO, PROCUREMENT OF SUBSTITUTE GOODS
 * OR SERVICES; LOSS OF USE, DATA, OR PROFITS; OR BUSINESS INTERRUPTION)
 * HOWEVER CAUSED AND ON ANY THEORY OF LIABILITY, WHETHER IN CONTRACT, STRICT
 * LIABILITY, OR TORT (INCLUDING NEGLIGENCE OR OTHERWISE) ARISING IN ANY WAY
 * OUT OF THE USE OF THIS SOFTWARE, EVEN IF ADVISED OF THE POSSIBILITY OF
 * SUCH DAMAGE.
 *
 * The licence and distribution terms for any publically available version or
 * derivative of this code cannot be changed. i.e. this code cannot simply be
 * copied and put under another distribution licence
 * [including the GNU Public Licence.]
 */

A.12.14 ncurses

Copyright (c) 1998-2010,2011 Free Software Foundation, Inc.

Permission is hereby granted, free of charge, to any person obtaining a copy of this software and associated documentation files (the "Software"), to deal in the Software without restriction, including without limitation the rights to use, copy, modify, merge, publish, distribute, distribute with modifications, sublicense, and/or sell copies of the Software, and to permit persons to whom the Software is furnished to do so, subject to the following conditions:

The above copyright notice and this permission notice shall be included in all copies or substantial portions of the Software.

THE SOFTWARE IS PROVIDED "AS IS", WITHOUT WARRANTY OF ANY KIND, EXPRESS OR IMPLIED, INCLUDING BUT NOT LIMITED TO THE WARRANTIES OF MERCHANTABILITY, FITNESS FOR A PARTICULAR PURPOSE AND NONINFRINGEMENT. IN NO EVENT SHALL THE ABOVE COPYRIGHT HOLDERS BE LIABLE FOR ANY CLAIM, DAMAGES OR OTHER LIABILITY, WHETHER IN AN ACTION OF CONTRACT, TORT OR OTHERWISE, ARISING FROM, OUT OF OR IN CONNECTION WITH THE SOFTWARE OR THE USE OR OTHER DEALINGS IN THE SOFTWARE.

Except as contained in this notice, the name(s) of the above copyright holders shall not be used in advertising or otherwise to promote the sale, use or other dealings in this Software without prior written authorization.

A.12.15 XZ Utils

This software includes code from XZ Utils <<http://tukaani.org/xz/>> Some parts of XZ Utils are covered under different free software licenses such as GNU LGPLv2.1, GNU GPLv2, or GNU GPLv3.

A.12.16 utils-linux-ng

The project utils-linux-ng doesn't use same license for all code. There are code with:

- * GPLv2+ (GNU General Public License version 2, or any later version)
- * GPLv2 (GNU General Public License version 2)
- * BSD with advertising * Public Domain

Flexigrid 1.1

The MIT License (MIT)

Copyright (c) <year> <copyright holders>

Permission is hereby granted, free of charge, to any person obtaining a copy of this software and associated documentation files (the "Software"), to deal in the Software without restriction, including without limitation the rights to use, copy, modify, merge, publish, distribute, sublicense, and/or sell copies of the Software, and to permit persons to whom the Software is furnished to do so, subject to the following conditions:

The above copyright notice and this permission notice shall be included in all copies or substantial portions of the Software.

THE SOFTWARE IS PROVIDED "AS IS", WITHOUT WARRANTY OF ANY KIND, EXPRESS OR IMPLIED, INCLUDING BUT NOT LIMITED TO THE WARRANTIES OF MERCHANTABILITY, FITNESS FOR A PARTICULAR PURPOSE AND NONINFRINGEMENT. IN NO EVENT SHALL THE AUTHORS OR COPYRIGHT HOLDERS BE LIABLE FOR ANY CLAIM, DAMAGES OR OTHER LIABILITY, WHETHER IN AN ACTION OF CONTRACT, TORT OR OTHERWISE, ARISING FROM, OUT OF OR IN CONNECTION WITH THE SOFTWARE OR THE USE OR OTHER DEALINGS IN THE SOFTWARE.

LWL 1.1

GNU GENERAL PUBLIC LICENSE
Version 2, June 1991

Copyright (C) 1989, 1991 Free Software Foundation, Inc. 59 Temple Place, Suite 330, Boston, MA 02111-1307 USA Everyone is permitted to copy and distribute verbatim copies of this license document, but changing it is not allowed.

Preamble

The licenses for most software are designed to take away your freedom to share and change it. By contrast, the GNU General Public License is intended to guarantee your freedom to share and change free software--to make sure the software is free for all its users. This General Public License applies to most of the Free Software Foundation's software and to any other program whose authors commit to using it. (Some other Free Software Foundation software is covered by the GNU Library General Public License instead.) You can apply it to your programs, too.

When we speak of free software, we are referring to freedom, not price. Our General Public Licenses are designed to make sure that you have the freedom to distribute copies of free software (and charge for this service if you wish), that you receive source code or can get it if you want it, that you can change the software or use pieces of it in new free programs; and that you know you can do these things.

To protect your rights, we need to make restrictions that forbid anyone to deny you these rights or to ask you to surrender the rights. These restrictions translate to certain responsibilities for you if you distribute copies of the software, or if you modify it.

For example, if you distribute copies of such a program, whether gratis or for a fee, you must give the recipients all the rights that you have. You must make sure that they, too, receive or can get the source code. And you must show them these terms so they know their rights.

We protect your rights with two steps: (1) copyright the software, and (2) offer you this license which gives you legal permission to copy, distribute and/or modify the software.

Also, for each author's protection and ours, we want to make certain that everyone understands that there is no warranty for this free software. If the software is modified by someone else and passed on, we want its recipients to know that what they have is not the original, so that any problems introduced by others will not reflect on the original authors' reputations.

Finally, any free program is threatened constantly by software patents. We wish to avoid the danger that redistributors of a free program will individually obtain patent licenses, in effect making the program proprietary. To prevent this, we have made it clear that any patent must be licensed for everyone's free use or not licensed at all.

The precise terms and conditions for copying, distribution and modification follow.

GNU GENERAL PUBLIC LICENSE
TERMS AND CONDITIONS FOR COPYING, DISTRIBUTION AND MODIFICATION

0. This License applies to any program or other work which contains a notice placed by the copyright holder saying it may be distributed under the terms of this General Public License. The "Program", below, refers to any such program or work, and a "work based on the Program" means either the Program or any derivative work under copyright law: that is to say, a work containing the Program or a portion of it, either verbatim or with modifications and/or translated into another language. (Hereinafter, translation is included without limitation in the term "modification".) Each licensee is addressed as "you".

Activities other than copying, distribution and modification are not covered by this License; they are outside its scope. The act of running the Program is not restricted, and the output from the Program is covered only if its contents constitute a work based on the Program (independent of having been made by running the Program). Whether that is true depends on what the Program does.

1. You may copy and distribute verbatim copies of the Program's source code as you receive it, in any medium, provided that you conspicuously and appropriately publish on each copy an appropriate copyright notice and disclaimer of warranty; keep intact all the notices that refer to this License and to the absence of any warranty; and give any other recipients of the Program a copy of this License along with the Program.

You may charge a fee for the physical act of transferring a copy, and you may at your option offer warranty protection in exchange for a fee.

2. You may modify your copy or copies of the Program or any portion of it, thus forming a work based on the Program, and copy and distribute such modifications or work under the terms of Section 1 above, provided that you also meet all of these conditions:

a) You must cause the modified files to carry prominent notices stating that you changed the files and the date of any change.

b) You must cause any work that you distribute or publish, that in whole or in part contains or is derived from the Program or any part thereof, to be licensed as a whole at no charge to all third parties under the terms of this License.

c) If the modified program normally reads commands interactively when run, you must cause it, when started running for such interactive use in the most ordinary way, to print or display an announcement including an appropriate copyright notice and a notice that there is no warranty (or else, saying that you provide a warranty) and that users may redistribute the program under these conditions, and telling the user how to view a copy of this License. (Exception: if the Program itself is interactive but does not normally print such an announcement, your work based on the Program is not required to print an announcement.)

These requirements apply to the modified work as a whole. If identifiable sections of that work are not derived from the Program, and can be reasonably considered independent and separate works in themselves, then this License, and its terms, do not apply to those sections when you distribute them as separate works. But when you distribute the same sections as part of a whole which is a work based on the Program, the distribution of the whole must be on the terms of this License, whose permissions for other licensees extend to the entire whole, and thus to each and every part regardless of who wrote it.

Thus, it is not the intent of this section to claim rights or contest your rights to work written entirely by you; rather, the intent is to exercise the right to control the distribution of derivative or collective works based on the Program.

In addition, mere aggregation of another work not based on the Program with the Program (or with a work based on the Program) on a volume of a storage or distribution medium does not bring the other work under the scope of this License.

3. You may copy and distribute the Program (or a work based on it, under Section 2) in object code or executable form under the terms of Sections 1 and 2 above provided that you also do one of the following:

a) Accompany it with the complete corresponding machine-readable source code, which must be distributed under the terms of Sections 1 and 2 above on a medium customarily used for software interchange; or,

b) Accompany it with a written offer, valid for at least three years, to give any third party, for a charge no more than your cost of physically performing source distribution, a complete machine-readable copy of the corresponding source code, to be distributed under the terms of Sections 1 and 2 above on a medium customarily used for software interchange; or,

c) Accompany it with the information you received as to the offer to distribute corresponding source code. (This alternative is allowed only for noncommercial distribution and only if you received the program in object code or executable form with such an offer, in accord with Subsection b above.)

The source code for a work means the preferred form of the work for making modifications to it. For an executable work, complete source code means all the source code for all modules it contains, plus any associated interface definition files, plus the scripts used to control compilation and installation of the executable. However, as a special exception, the source code distributed need not include anything that is normally distributed (in either source or binary form) with the major components (compiler, kernel, and so on) of the operating system on which the executable runs, unless that component itself accompanies the executable.

If distribution of executable or object code is made by offering access to copy from a designated place, then offering equivalent access to copy the source code from the same place counts as distribution of the source code, even though third parties are not compelled to copy the source along with the object code.

4. You may not copy, modify, sublicense, or distribute the Program except as expressly provided under this License. Any attempt otherwise to copy, modify, sublicense or distribute the Program is void, and will automatically terminate your rights under this License. However, parties who have received copies, or rights, from you under this License will not have their licenses terminated so long as such parties remain in full compliance.

5. You are not required to accept this License, since you have not signed it. However, nothing else grants you permission to modify or distribute the Program or its derivative works. These actions are prohibited by law if you do not accept this License. Therefore, by modifying or distributing the Program (or any work based on the Program), you indicate your acceptance of this License to do so, and all its terms and conditions for copying, distributing or modifying the Program or works based on it.

6. Each time you redistribute the Program (or any work based on the Program), the recipient automatically receives a license from the original licensor to copy, distribute or modify the Program subject to these terms and conditions. You may not impose any further restrictions on the recipients' exercise of the rights granted herein. You are not responsible for enforcing compliance by third parties to this License.

7. If, as a consequence of a court judgment or allegation of patent infringement or for any other reason (not limited to patent issues), conditions are imposed on you (whether by court order, agreement or otherwise) that contradict the conditions of this License, they do not excuse you from the conditions of this License. If you cannot distribute so as to satisfy simultaneously your obligations under this License and any other pertinent obligations, then as a consequence you may not distribute the Program at all. For example, if a patent license would not permit royalty-free redistribution of the Program by all those who receive copies directly or indirectly through you, then the only way you could satisfy both it and this License would be to refrain entirely from distribution of the Program.

If any portion of this section is held invalid or unenforceable under any particular circumstance, the balance of the section is intended to apply and the section as a whole is intended to apply in other circumstances.

It is not the purpose of this section to induce you to infringe any patents or other property right claims or to contest validity of any such claims; this section has the sole purpose of protecting the integrity of the free software distribution system, which is implemented by public license practices. Many people have made generous contributions to the wide range of software distributed through that system in reliance on consistent application of that system; it is up to the author/donor to decide if he or she is willing to distribute software through any other system and a licensee cannot impose that choice.

This section is intended to make thoroughly clear what is believed to be a consequence of the rest of this License.

8. If the distribution and/or use of the Program is restricted in certain countries either by patents or by copyrighted interfaces, the original copyright holder who places the Program under this License may add an explicit geographical distribution limitation excluding those countries, so that distribution is permitted only in or among countries not thus excluded. In such case, this License incorporates the limitation as if written in the body of this License.

9. The Free Software Foundation may publish revised and/or new versions of the General Public License from time to time. Such new versions will be similar in spirit to the present version, but may differ in detail to address new problems or concerns.

Each version is given a distinguishing version number. If the Program specifies a version number of this License which applies to it and "any later version", you have the option of following the terms and conditions either of that version or

of any later version published by the Free Software Foundation. If the Program does not specify a version number of this License, you may choose any version ever published by the Free Software Foundation.

10. If you wish to incorporate parts of the Program into other free programs whose distribution conditions are different, write to the author to ask for permission. For software which is copyrighted by the Free Software Foundation, write to the Free Software Foundation; we sometimes make exceptions for this. Our decision will be guided by the two goals of preserving the free status of all derivatives of our free software and of promoting the sharing and reuse of software generally.

NO WARRANTY

11. BECAUSE THE PROGRAM IS LICENSED FREE OF CHARGE, THERE IS NO WARRANTY FOR THE PROGRAM, TO THE EXTENT PERMITTED BY APPLICABLE LAW. EXCEPT WHEN OTHERWISE STATED IN WRITING THE COPYRIGHT HOLDERS AND/OR OTHER PARTIES PROVIDE THE PROGRAM "AS IS" WITHOUT WARRANTY OF ANY KIND, EITHER EXPRESSED OR IMPLIED, INCLUDING, BUT NOT LIMITED TO, THE IMPLIED WARRANTIES OF MERCHANTABILITY AND FITNESS FOR A PARTICULAR PURPOSE. THE ENTIRE RISK AS TO THE QUALITY AND PERFORMANCE OF THE PROGRAM IS WITH YOU. SHOULD THE PROGRAM PROVE DEFECTIVE, YOU ASSUME THE COST OF ALL NECESSARY SERVICING, REPAIR OR CORRECTION.

12. IN NO EVENT UNLESS REQUIRED BY APPLICABLE LAW OR AGREED TO IN WRITING WILL ANY COPYRIGHT HOLDER, OR ANY OTHER PARTY WHO MAY MODIFY AND/OR REDISTRIBUTE THE PROGRAM AS PERMITTED ABOVE, BE LIABLE TO YOU FOR DAMAGES, INCLUDING ANY GENERAL, SPECIAL, INCIDENTAL OR CONSEQUENTIAL DAMAGES ARISING OUT OF THE USE OR INABILITY TO USE THE PROGRAM (INCLUDING BUT NOT LIMITED TO LOSS OF DATA OR DATA BEING RENDERED INACCURATE OR LOSSES SUSTAINED BY YOU OR THIRD PARTIES OR A FAILURE OF THE PROGRAM TO OPERATE WITH ANY OTHER PROGRAMS), EVEN IF SUCH HOLDER OR OTHER PARTY HAS BEEN ADVISED OF THE POSSIBILITY OF SUCH DAMAGES.

END OF TERMS AND CONDITIONS

How to Apply These Terms to Your New Programs

If you develop a new program, and you want it to be of the greatest possible use to the public, the best way to achieve this is to make it free software which everyone can redistribute and change under these terms.

To do so, attach the following notices to the program. It is safest to attach them to the start of each source file to most effectively convey the exclusion of warranty; and each file should have at least the "copyright" line and a pointer to where the full notice is found.

```
<one line to give the program's name and a brief idea of what it does.>
Copyright (C) <year> <name of author>
```

```
This program is free software; you can redistribute it and/or modify it
under the terms of the GNU General Public License as published by the Free
Software Foundation; either version 2 of the License, or (at your option) any
later version.
```

```
This program is distributed in the hope that it will be useful, but WITHOUT
ANY WARRANTY; without even the implied warranty of MERCHANTABILITY or FITNESS
FOR A PARTICULAR PURPOSE. See the GNU General Public License for more details.
```

```
You should have received a copy of the GNU General Public License along
with this program; if not, write to the Free Software Foundation, Inc., 59
Temple Place, Suite 330, Boston, MA 02111-1307 USA
```

Also add information on how to contact you by electronic and paper mail.

If the program is interactive, make it output a short notice like this when it starts in an interactive mode:

Gnomovision version 69, Copyright (C) year name of author Gnomovision comes with ABSOLUTELY NO WARRANTY; for details type `show w'. This is free software, and you are welcome to redistribute it under certain conditions; type `show c' for details.

The hypothetical commands `show w' and `show c' should show the appropriate parts of the General Public License. Of course, the commands you use may be called something other than `show w' and `show c'; they could even be mouse-clicks or menu items--whatever suits your program.

You should also get your employer (if you work as a programmer) or your school, if any, to sign a "copyright disclaimer" for the program, if necessary. Here is a sample; alter the names:

```
Yoyodyne, Inc., hereby disclaims all copyright interest in the program
`Gnomovision' (which makes passes at compilers) written by James Hacker.
```

```
<signature of Ty Coon>, 1 April 1989 Ty Coon, President of Vice
```

This General Public License does not permit incorporating your program into proprietary programs. If your program is a subroutine library, you may consider it more useful to permit linking proprietary applications with the library. If this is what you want to do, use the GNU Library General Public License instead of this License.

Penlight cbfe7d3a715543928a42a826148253c9dbeea13e

Copyright (C) 2009 Steve Donovan, David Manura.

Permission is hereby granted, free of charge, to any person obtaining a copy of this software and associated documentation files (the "Software"), to deal in the Software without restriction, including without limitation the rights to use, copy, modify, merge, publish, distribute, sublicense, and/or sell copies of the Software, and to permit persons to whom the Software is furnished to do so, subject to the following conditions:

The above copyright notice and this permission notice shall be included in all copies or substantial portions of the Software.

THE SOFTWARE IS PROVIDED "AS IS", WITHOUT WARRANTY OF ANY KIND, EXPRESS OR IMPLIED, INCLUDING BUT NOT LIMITED TO THE WARRANTIES OF MERCHANTABILITY, FITNESS FOR A PARTICULAR PURPOSE AND NONINFRINGEMENT. IN NO EVENT SHALL THE AUTHORS OR COPYRIGHT HOLDERS BE LIABLE FOR ANY CLAIM, DAMAGES OR OTHER LIABILITY, WHETHER IN AN ACTION OF CONTRACT, TORT OR OTHERWISE, ARISING FROM, OUT OF OR IN CONNECTION WITH THE SOFTWARE OR THE USE OR OTHER DEALINGS IN THE SOFTWARE.

SourceSansPro

Copyright (c) <dates>, <Copyright Holder> (<URL|email>), with Reserved Font Name <Reserved Font Name>. Copyright (c) <dates>, <additional Copyright Holder> (<URL|email>), with Reserved Font Name <additional Reserved Font Name>. Copyright (c) <dates>, <additional Copyright Holder> (<URL|email>).

This Font Software is licensed under the SIL Open Font License, Version 1.1. This license is copied below, and is also available with a FAQ at: <http://scripts.sil.org/OFL>

SIL OPEN FONT LICENSE Version 1.1 - 26 February 2007

PREAMBLE The goals of the Open Font License (OFL) are to stimulate worldwide development of collaborative font projects, to support the font creation efforts of academic and linguistic communities, and to provide a free and open framework in which fonts may be shared and improved in partnership with others.

The OFL allows the licensed fonts to be used, studied, modified and redistributed freely as long as they are not sold by themselves. The fonts, including any derivative works, can be bundled, embedded, redistributed and/or sold with any software provided that any reserved names are not used by derivative works. The fonts and derivatives, however, cannot be released under any other type of license. The requirement for fonts to remain under this license does not apply to any document created using the fonts or their derivatives.

DEFINITIONS "Font Software" refers to the set of files released by the Copyright Holder(s) under this license and clearly marked as such. This may include source files, build scripts and documentation.

"Reserved Font Name" refers to any names specified as such after the copyright statement(s).

"Original Version" refers to the collection of Font Software components as distributed by the Copyright Holder(s).

"Modified Version" refers to any derivative made by adding to, deleting, or substituting -- in part or in whole -- any of the components of the Original Version, by changing formats or by porting the Font Software to a new environment.

"Author" refers to any designer, engineer, programmer, technical writer or other person who contributed to the Font Software.

PERMISSION & CONDITIONS Permission is hereby granted, free of charge, to any person obtaining a copy of the Font Software, to use, study, copy, merge, embed, modify, redistribute, and sell modified and unmodified copies of the Font Software, subject to the following conditions:

- 1) Neither the Font Software nor any of its individual components, in Original or Modified Versions, may be sold by itself.
- 2) Original or Modified Versions of the Font Software may be bundled, redistributed and/or sold with any software, provided that each copy contains the above copyright notice and this license. These can be included either as stand-alone text files, human-readable headers or in the appropriate machine-readable metadata fields within text or binary files as long as those fields can be easily viewed by the user.
- 3) No Modified Version of the Font Software may use the Reserved Font Name(s) unless explicit written permission is granted by the corresponding Copyright Holder. This restriction only applies to the primary font name as presented to the users.
- 4) The name(s) of the Copyright Holder(s) or the Author(s) of the Font Software shall not be used to promote, endorse or advertise any Modified Version, except to acknowledge the contribution(s) of the Copyright Holder(s) and the Author(s) or with their explicit written permission.
- 5) The Font Software, modified or unmodified, in part or in whole, must be distributed entirely under this license, and must not be distributed under any other license. The requirement for fonts to remain under this license does not apply to any document created using the Font Software.

TERMINATION This license becomes null and void if any of the above conditions are not met.

DISCLAIMER THE FONT SOFTWARE IS PROVIDED "AS IS", WITHOUT WARRANTY OF ANY KIND, EXPRESS OR IMPLIED, INCLUDING BUT NOT LIMITED TO ANY WARRANTIES OF MERCHANTABILITY, FITNESS FOR A PARTICULAR PURPOSE AND NONINFRINGEMENT OF COPYRIGHT, PATENT, TRADEMARK, OR OTHER RIGHT. IN NO EVENT SHALL THE COPYRIGHT

HOLDER BE LIABLE FOR ANY CLAIM, DAMAGES OR OTHER LIABILITY, INCLUDING ANY GENERAL, SPECIAL, INDIRECT, INCIDENTAL, OR CONSEQUENTIAL DAMAGES, WHETHER IN AN ACTION OF CONTRACT, TORT OR OTHERWISE, ARISING FROM, OUT OF THE USE OR INABILITY TO USE THE FONT SOFTWARE OR FROM OTHER DEALINGS IN THE FONT SOFTWARE.

busybox 1.22.1

--- A note on GPL versions

BusyBox is distributed under version 2 of the General Public License (included in its entirety, below). Version 2 is the only version of this license which this version of BusyBox (or modified versions derived from this one) may be distributed under.

GNU GENERAL PUBLIC LICENSE
Version 2, June 1991

Copyright (C) 1989, 1991 Free Software Foundation, Inc. 51 Franklin St,
Fifth Floor, Boston, MA 02110-1301 USA Everyone is permitted to copy and
distribute verbatim copies of this license document, but changing it is not
allowed.

Preamble

The licenses for most software are designed to take away your freedom to share and change it. By contrast, the GNU General Public License is intended to guarantee your freedom to share and change free software--to make sure the software is free for all its users. This General Public License applies to most of the Free Software Foundation's software and to any other program whose authors commit to using it. (Some other Free Software Foundation software is covered by the GNU Library General Public License instead.) You can apply it to your programs, too.

When we speak of free software, we are referring to freedom, not price. Our General Public Licenses are designed to make sure that you have the freedom to distribute copies of free software (and charge for this service if you wish), that you receive source code or can get it if you want it, that you can change the software or use pieces of it in new free programs; and that you know you can do these things.

To protect your rights, we need to make restrictions that forbid anyone to deny you these rights or to ask you to surrender the rights. These restrictions translate to certain responsibilities for you if you distribute copies of the software, or if you modify it.

For example, if you distribute copies of such a program, whether gratis or for a fee, you must give the recipients all the rights that you have. You must make sure that they, too, receive or can get the source code. And you must show them these terms so they know their rights.

We protect your rights with two steps: (1) copyright the software, and (2) offer you this license which gives you legal permission to copy, distribute and/or modify the software.

Also, for each author's protection and ours, we want to make certain that everyone understands that there is no warranty for this free software. If the software is modified by someone else and passed on, we want its recipients to know that what they have is not the original, so that any problems introduced by others will not reflect on the original authors' reputations.

Finally, any free program is threatened constantly by software patents. We wish to avoid the danger that redistributors of a free program will individually obtain patent licenses, in effect making the program proprietary. To prevent this, we have made it clear that any patent must be licensed for everyone's free use or not licensed at all.

The precise terms and conditions for copying, distribution and modification follow.

GNU GENERAL PUBLIC LICENSE
TERMS AND CONDITIONS FOR COPYING, DISTRIBUTION AND MODIFICATION

0. This License applies to any program or other work which contains a notice placed by the copyright holder saying it may be distributed under the terms of this General Public License. The "Program", below, refers to any such program or work, and a "work based on the Program" means either the Program or any derivative work under copyright law: that is to say, a work containing the Program or a portion of it, either verbatim or with modifications and/or translated into another language. (Hereinafter, translation is included without limitation in the term "modification".) Each licensee is addressed as "you".

Activities other than copying, distribution and modification are not covered by this License; they are outside its scope. The act of running the Program is not restricted, and the output from the Program is covered only if its contents constitute a work based on the Program (independent of having been made by running the Program). Whether that is true depends on what the Program does.

1. You may copy and distribute verbatim copies of the Program's source code as you receive it, in any medium, provided that you conspicuously and appropriately publish on each copy an appropriate copyright notice and disclaimer of warranty; keep intact all the notices that refer to this License and to the absence of any warranty; and give any other recipients of the Program a copy of this License along with the Program.

You may charge a fee for the physical act of transferring a copy, and you may at your option offer warranty protection in exchange for a fee.

2. You may modify your copy or copies of the Program or any portion of it, thus forming a work based on the Program, and copy and distribute such modifications or work under the terms of Section 1 above, provided that you also meet all of these conditions:

a) You must cause the modified files to carry prominent notices stating that you changed the files and the date of any change.

b) You must cause any work that you distribute or publish, that in whole or in part contains or is derived from the Program or any part thereof, to be licensed as a whole at no charge to all third parties under the terms of this License.

c) If the modified program normally reads commands interactively when run, you must cause it, when started running for such interactive use in the most ordinary way, to print or display an announcement including an appropriate copyright notice and a notice that there is no warranty (or else, saying that you provide a warranty) and that users may redistribute the program under these conditions, and telling the user how to view a copy of this License. (Exception: if the Program itself is interactive but does not normally print such an announcement, your work based on the Program is not required to print an announcement.)

These requirements apply to the modified work as a whole. If identifiable sections of that work are not derived from the Program, and can be reasonably considered independent and separate works in themselves, then this License, and its terms, do not apply to those sections when you distribute them as separate works. But when you distribute the same sections as part of a whole which is a work based on

the Program, the distribution of the whole must be on the terms of this License, whose permissions for other licensees extend to the entire whole, and thus to each and every part regardless of who wrote it.

Thus, it is not the intent of this section to claim rights or contest your rights to work written entirely by you; rather, the intent is to exercise the right to control the distribution of derivative or collective works based on the Program.

In addition, mere aggregation of another work not based on the Program with the Program (or with a work based on the Program) on a volume of a storage or distribution medium does not bring the other work under the scope of this License.

3. You may copy and distribute the Program (or a work based on it, under Section 2) in object code or executable form under the terms of Sections 1 and 2 above provided that you also do one of the following:

a) Accompany it with the complete corresponding machine-readable source code, which must be distributed under the terms of Sections 1 and 2 above on a medium customarily used for software interchange; or,

b) Accompany it with a written offer, valid for at least three years, to give any third party, for a charge no more than your cost of physically performing source distribution, a complete machine-readable copy of the corresponding source code, to be distributed under the terms of Sections 1 and 2 above on a medium customarily used for software interchange; or,

c) Accompany it with the information you received as to the offer to distribute corresponding source code. (This alternative is allowed only for noncommercial distribution and only if you received the program in object code or executable form with such an offer, in accord with Subsection b above.)

The source code for a work means the preferred form of the work for making modifications to it. For an executable work, complete source code means all the source code for all modules it contains, plus any associated interface definition files, plus the scripts used to control compilation and installation of the executable. However, as a special exception, the source code distributed need not include anything that is normally distributed (in either source or binary form) with the major components (compiler, kernel, and so on) of the operating system on which the executable runs, unless that component itself accompanies the executable.

If distribution of executable or object code is made by offering access to copy from a designated place, then offering equivalent access to copy the source code from the same place counts as distribution of the source code, even though third parties are not compelled to copy the source along with the object code.

4. You may not copy, modify, sublicense, or distribute the Program except as expressly provided under this License. Any attempt otherwise to copy, modify, sublicense or distribute the Program is void, and will automatically terminate your rights under this License. However, parties who have received copies, or rights, from you under this License will not have their licenses terminated so long as such parties remain in full compliance.

5. You are not required to accept this License, since you have not signed it. However, nothing else grants you permission to modify or distribute the Program or its derivative works. These actions are prohibited by law if you do not accept this License. Therefore, by modifying or distributing the Program (or any work based on the Program), you indicate your acceptance of this License to do so, and all its terms and conditions for copying, distributing or modifying the Program or works based on it.

6. Each time you redistribute the Program (or any work based on the Program), the recipient automatically receives a license from the original licensor to copy, distribute or modify the Program subject to these terms and conditions. You may not impose any further restrictions on the recipients' exercise of the rights granted herein. You are not responsible for enforcing compliance by third parties to this License.

7. If, as a consequence of a court judgment or allegation of patent infringement or for any other reason (not limited to patent issues), conditions are imposed on you (whether by court order, agreement or otherwise) that contradict the conditions of this License, they do not excuse you from the conditions of this License. If you cannot distribute so as to satisfy simultaneously your obligations under this License and any other pertinent obligations, then as a consequence you may not distribute the Program at all. For example, if a patent license would not permit royalty-free redistribution of the Program by all those who receive copies directly or indirectly through you, then the only way you could satisfy both it and this License would be to refrain entirely from distribution of the Program.

If any portion of this section is held invalid or unenforceable under any particular circumstance, the balance of the section is intended to apply and the section as a whole is intended to apply in other circumstances.

It is not the purpose of this section to induce you to infringe any patents or other property right claims or to contest validity of any such claims; this section has the sole purpose of protecting the integrity of the free software distribution system, which is implemented by public license practices. Many people have made generous contributions to the wide range of software distributed through that system in reliance on consistent application of that system; it is up to the author/donor to decide if he or she is willing to distribute software through any other system and a licensee cannot impose that choice.

This section is intended to make thoroughly clear what is believed to be a consequence of the rest of this License.

8. If the distribution and/or use of the Program is restricted in certain countries either by patents or by copyrighted interfaces, the original copyright holder who places the Program under this License may add an explicit geographical distribution limitation excluding those countries, so that distribution is permitted only in or among countries not thus excluded. In such case, this License incorporates the limitation as if written in the body of this License.

9. The Free Software Foundation may publish revised and/or new versions of the General Public License from time to time. Such new versions will be similar in spirit to the present version, but may differ in detail to address new problems or concerns.

Each version is given a distinguishing version number. If the Program specifies a version number of this License which applies to it and "any later version", you have the option of following the terms and conditions either of that version or of any later version published by the Free Software Foundation. If the Program does not specify a version number of this License, you may choose any version ever published by the Free Software Foundation.

10. If you wish to incorporate parts of the Program into other free programs whose distribution conditions are different, write to the author to ask for permission. For software which is copyrighted by the Free Software Foundation, write to the Free Software Foundation; we sometimes make exceptions for this. Our decision will be guided by the two goals of preserving the free status of all derivatives of our free software and of promoting the sharing and reuse of software generally.

NO WARRANTY

11. BECAUSE THE PROGRAM IS LICENSED FREE OF CHARGE, THERE IS NO WARRANTY FOR THE PROGRAM, TO THE EXTENT PERMITTED BY APPLICABLE LAW. EXCEPT WHEN OTHERWISE STATED IN WRITING THE COPYRIGHT HOLDERS AND/OR OTHER PARTIES PROVIDE THE PROGRAM "AS IS" WITHOUT WARRANTY OF ANY KIND, EITHER EXPRESSED OR IMPLIED, INCLUDING, BUT NOT LIMITED TO, THE IMPLIED WARRANTIES OF MERCHANTABILITY AND FITNESS FOR A PARTICULAR PURPOSE. THE ENTIRE RISK AS TO THE QUALITY AND PERFORMANCE OF THE PROGRAM IS WITH YOU. SHOULD THE PROGRAM PROVE DEFECTIVE, YOU ASSUME THE COST OF ALL NECESSARY SERVICING, REPAIR OR CORRECTION.

12. IN NO EVENT UNLESS REQUIRED BY APPLICABLE LAW OR AGREED TO IN WRITING WILL ANY COPYRIGHT HOLDER, OR ANY OTHER PARTY WHO MAY MODIFY AND/OR REDISTRIBUTE THE PROGRAM AS PERMITTED ABOVE, BE LIABLE TO YOU FOR DAMAGES, INCLUDING ANY GENERAL, SPECIAL, INCIDENTAL OR CONSEQUENTIAL DAMAGES ARISING OUT OF THE USE OR INABILITY TO USE THE PROGRAM (INCLUDING BUT NOT LIMITED TO LOSS OF DATA OR DATA BEING RENDERED INACCURATE OR LOSSES SUSTAINED BY YOU OR THIRD PARTIES OR A FAILURE OF THE PROGRAM TO OPERATE WITH ANY OTHER PROGRAMS), EVEN IF SUCH HOLDER OR OTHER PARTY HAS BEEN ADVISED OF THE POSSIBILITY OF SUCH DAMAGES.

END OF TERMS AND CONDITIONS
How to Apply These Terms to Your New Programs

If you develop a new program, and you want it to be of the greatest possible use to the public, the best way to achieve this is to make it free software which everyone can redistribute and change under these terms.

To do so, attach the following notices to the program. It is safest to attach them to the start of each source file to most effectively convey the exclusion of warranty; and each file should have at least the "copyright" line and a pointer to where the full notice is found.

```
<one line to give the program's name and a brief idea of what it does.>
Copyright (C) <year> <name of author>
```

This program is free software; you can redistribute it and/or modify it under the terms of the GNU General Public License as published by the Free Software Foundation; either version 2 of the License, or (at your option) any later version.

This program is distributed in the hope that it will be useful, but WITHOUT ANY WARRANTY; without even the implied warranty of MERCHANTABILITY or FITNESS FOR A PARTICULAR PURPOSE. See the GNU General Public License for more details.

You should have received a copy of the GNU General Public License along with this program; if not, write to the Free Software Foundation, Inc., 51 Franklin St, Fifth Floor, Boston, MA 02110-1301 USA

Also add information on how to contact you by electronic and paper mail.

If the program is interactive, make it output a short notice like this when it starts in an interactive mode:

```
Gnomovision version 69, Copyright (C) year name of author Gnomovision
comes with ABSOLUTELY NO WARRANTY; for details type `show w'. This is free
software, and you are welcome to redistribute it under certain conditions;
type `show c' for details.
```

The hypothetical commands `show w' and `show c' should show the appropriate parts of the General Public License. Of course, the commands you use may be called something other than `show w' and `show c'; they could even be mouse-clicks or menu items--whatever suits your program.

You should also get your employer (if you work as a programmer) or your school, if any, to sign a "copyright disclaimer" for the program, if necessary. Here is a sample; alter the names:

```
Yoyodyne, Inc., hereby disclaims all copyright interest in the program
`Gnomovision' (which makes passes at compilers) written by James Hacker.
```

```
<signature of Ty Coon>, 1 April 1989 Ty Coon, President of Vice
```

This General Public License does not permit incorporating your program into proprietary programs. If your program is a subroutine library, you may consider it more useful to permit linking proprietary applications with the library. If this is what you want to do, use the GNU Library General Public License instead of this License.

coreutils 8.16GNU GENERAL PUBLIC LICENSE
Version 3, 29 June 2007

Copyright (C) 2007 Free Software Foundation, Inc. <<http://fsf.org/>> Everyone is permitted to copy and distribute verbatim copies of this license document, but changing it is not allowed.

Preamble

The GNU General Public License is a free, copyleft license for software and other kinds of works.

The licenses for most software and other practical works are designed to take away your freedom to share and change the works. By contrast, the GNU General Public License is intended to guarantee your freedom to share and change all versions of a program--to make sure it remains free software for all its users. We, the Free Software Foundation, use the GNU General Public License for most of our software; it applies also to any other work released this way by its authors. You can apply it to your programs, too.

When we speak of free software, we are referring to freedom, not price. Our General Public Licenses are designed to make sure that you have the freedom to distribute copies of free software (and charge for them if you wish), that you receive source code or can get it if you want it, that you can change the software or use pieces of it in new free programs, and that you know you can do these things.

To protect your rights, we need to prevent others from denying you these rights or asking you to surrender the rights. Therefore, you have certain responsibilities if you distribute copies of the software, or if you modify it: responsibilities to respect the freedom of others.

For example, if you distribute copies of such a program, whether gratis or for a fee, you must pass on to the recipients the same freedoms that you received. You must make sure that they, too, receive or can get the source code. And you must show them these terms so they know their rights.

Developers that use the GNU GPL protect your rights with two steps: (1) assert copyright on the software, and (2) offer you this License giving you legal permission to copy, distribute and/or modify it.

For the developers' and authors' protection, the GPL clearly explains that there is no warranty for this free software. For both users' and authors' sake, the GPL requires that modified versions be marked as changed, so that their problems will not be attributed erroneously to authors of previous versions.

Some devices are designed to deny users access to install or run modified versions of the software inside them, although the manufacturer can do so. This is fundamentally incompatible with the aim of protecting users' freedom to change the software. The systematic pattern of such abuse occurs in the area of products for individuals to use, which is precisely where it is most unacceptable. Therefore, we have designed this version of the GPL to prohibit the practice for those products. If such problems arise substantially in other domains, we stand ready to extend this provision to those domains in future versions of the GPL, as needed to protect the freedom of users.

Finally, every program is threatened constantly by software patents. States should not allow patents to restrict development and use of software on general-purpose computers, but in those that do, we wish to avoid the special danger that patents applied to a free program could make it effectively proprietary. To prevent this, the GPL assures that patents cannot be used to render the program non-free.

The precise terms and conditions for copying, distribution and modification follow.

TERMS AND CONDITIONS

0. Definitions.

"This License" refers to version 3 of the GNU General Public License.

"Copyright" also means copyright-like laws that apply to other kinds of works, such as semiconductor masks.

"The Program" refers to any copyrightable work licensed under this License. Each licensee is addressed as "you". "Licensees" and "recipients" may be individuals or organizations.

To "modify" a work means to copy from or adapt all or part of the work in a fashion requiring copyright permission, other than the making of an exact copy. The resulting work is called a "modified version" of the earlier work or a work "based on" the earlier work.

A "covered work" means either the unmodified Program or a work based on the Program.

To "propagate" a work means to do anything with it that, without permission, would make you directly or secondarily liable for infringement under applicable copyright law, except executing it on a computer or modifying a private copy. Propagation includes copying, distribution (with or without modification), making available to the public, and in some countries other activities as well.

To "convey" a work means any kind of propagation that enables other parties to make or receive copies. Mere interaction with a user through a computer network, with no transfer of a copy, is not conveying.

An interactive user interface displays "Appropriate Legal Notices" to the extent that it includes a convenient and prominently visible feature that (1) displays an appropriate copyright notice, and (2) tells the user that there is no warranty for the work (except to the extent that warranties are provided), that licensees may convey the work under this License, and how to view a copy of this License. If the interface presents a list of user commands or options, such as a menu, a prominent item in the list meets this criterion.

1. Source Code.

The "source code" for a work means the preferred form of the work for making modifications to it. "Object code" means any non-source form of a work.

A "Standard Interface" means an interface that either is an official standard defined by a recognized standards body, or, in the case of interfaces specified for a particular programming language, one that is widely used among developers working in that language.

The "System Libraries" of an executable work include anything, other than the work as a whole, that (a) is included in the normal form of packaging a Major Component, but which is not part of that Major Component, and (b) serves only to enable use of the work with that Major Component, or to implement a Standard Interface for which an implementation is available to the public in source code form. A "Major Component", in this context, means a major essential component (kernel, window system, and so on) of the specific operating system (if any) on which the executable work runs, or a compiler used to produce the work, or an object code interpreter used to run it.

The "Corresponding Source" for a work in object code form means all the source code needed to generate, install, and (for an executable work) run the object code and to modify the work, including scripts to control those activities. However, it does not include the work's System Libraries, or general-purpose tools or generally available free programs which are used unmodified in performing those activities but which are not part of the work. For example, Corresponding Source includes interface definition files associated with source files for the work, and the source code for shared libraries and dynamically linked subprograms that

the work is specifically designed to require, such as by intimate data communication or control flow between those subprograms and other parts of the work.

The Corresponding Source need not include anything that users can regenerate automatically from other parts of the Corresponding Source.

The Corresponding Source for a work in source code form is that same work.

2. Basic Permissions.

All rights granted under this License are granted for the term of copyright on the Program, and are irrevocable provided the stated conditions are met. This License explicitly affirms your unlimited permission to run the unmodified Program. The output from running a covered work is covered by this License only if the output, given its content, constitutes a covered work. This License acknowledges your rights of fair use or other equivalent, as provided by copyright law.

You may make, run and propagate covered works that you do not convey, without conditions so long as your license otherwise remains in force. You may convey covered works to others for the sole purpose of having them make modifications exclusively for you, or provide you with facilities for running those works, provided that you comply with the terms of this License in conveying all material for which you do not control copyright. Those thus making or running the covered works for you must do so exclusively on your behalf, under your direction and control, on terms that prohibit them from making any copies of your copyrighted material outside their relationship with you.

Conveying under any other circumstances is permitted solely under the conditions stated below. Sublicensing is not allowed; section 10 makes it unnecessary.

3. Protecting Users' Legal Rights From Anti-Circumvention Law.

No covered work shall be deemed part of an effective technological measure under any applicable law fulfilling obligations under article 11 of the WIPO copyright treaty adopted on 20 December 1996, or similar laws prohibiting or restricting circumvention of such measures.

When you convey a covered work, you waive any legal power to forbid circumvention of technological measures to the extent such circumvention is effected by exercising rights under this License with respect to the covered work, and you disclaim any intention to limit operation or modification of the work as a means of enforcing, against the work's users, your or third parties' legal rights to forbid circumvention of technological measures.

4. Conveying Verbatim Copies.

You may convey verbatim copies of the Program's source code as you receive it, in any medium, provided that you conspicuously and appropriately publish on each copy an appropriate copyright notice; keep intact all notices stating that this License and any non-permissive terms added in accord with section 7 apply to the code; keep intact all notices of the absence of any warranty; and give all recipients a copy of this License along with the Program.

You may charge any price or no price for each copy that you convey, and you may offer support or warranty protection for a fee.

5. Conveying Modified Source Versions.

You may convey a work based on the Program, or the modifications to produce it from the Program, in the form of source code under the terms of section 4, provided that you also meet all of these conditions:

a) The work must carry prominent notices stating that you modified it, and giving a relevant date.

b) The work must carry prominent notices stating that it is released under this License and any conditions added under section 7. This requirement modifies the requirement in section 4 to "keep intact all notices".

c) You must license the entire work, as a whole, under this License to anyone who comes into possession of a copy. This License will therefore apply, along with any applicable section 7 additional terms, to the whole of the work, and all its parts, regardless of how they are packaged. This License gives no permission to license the work in any other way, but it does not invalidate such permission if you have separately received it.

d) If the work has interactive user interfaces, each must display Appropriate Legal Notices; however, if the Program has interactive interfaces that do not display Appropriate Legal Notices, your work need not make them do so.

A compilation of a covered work with other separate and independent works, which are not by their nature extensions of the covered work, and which are not combined with it such as to form a larger program, in or on a volume of a storage or distribution medium, is called an "aggregate" if the compilation and its resulting copyright are not used to limit the access or legal rights of the compilation's users beyond what the individual works permit. Inclusion of a covered work in an aggregate does not cause this License to apply to the other parts of the aggregate.

6. Conveying Non-Source Forms.

You may convey a covered work in object code form under the terms of sections 4 and 5, provided that you also convey the machine-readable Corresponding Source under the terms of this License, in one of these ways:

a) Convey the object code in, or embodied in, a physical product (including a physical distribution medium), accompanied by the Corresponding Source fixed on a durable physical medium customarily used for software interchange.

b) Convey the object code in, or embodied in, a physical product (including a physical distribution medium), accompanied by a written offer, valid for at least three years and valid for as long as you offer spare parts or customer support for that product model, to give anyone who possesses the object code either (1) a copy of the Corresponding Source for all the software in the product that is covered by this License, on a durable physical medium customarily used for software interchange, for a price no more than your reasonable cost of physically performing this conveying of source, or (2) access to copy the Corresponding Source from a network server at no charge.

c) Convey individual copies of the object code with a copy of the written offer to provide the Corresponding Source. This alternative is allowed only occasionally and noncommercially, and only if you received the object code with such an offer, in accord with subsection 6b.

d) Convey the object code by offering access from a designated place (gratis or for a charge), and offer equivalent access to the Corresponding Source in the same way through the same place at no further charge. You need not require recipients to copy the Corresponding Source along with the object code. If the place to copy the object code is a network server, the Corresponding Source may be on a different server (operated by you or a third party) that supports equivalent copying facilities, provided you maintain clear directions next to the object code saying where to find the Corresponding Source. Regardless of what server hosts the Corresponding Source, you remain obligated to ensure that it is available for as long as needed to satisfy these requirements.

e) Convey the object code using peer-to-peer transmission, provided you inform other peers where the object code and Corresponding Source of the work are being offered to the general public at no charge under subsection 6d.

A separable portion of the object code, whose source code is excluded from the Corresponding Source as a System Library, need not be included in conveying the object code work.

A "User Product" is either (1) a "consumer product", which means any tangible personal property which is normally used for personal, family, or household purposes, or (2) anything designed or sold for incorporation into a dwelling. In determining whether a product is a consumer product, doubtful cases shall be resolved in favor of coverage. For a particular product received by a particular user, "normally used" refers to a typical or common use of that class of product, regardless of the status of the particular user or of the way in which the particular user actually uses, or expects or is expected to use, the product. A product is a consumer product regardless of whether the product has substantial commercial, industrial or non-consumer uses, unless such uses represent the only significant mode of use of the product.

"Installation Information" for a User Product means any methods, procedures, authorization keys, or other information required to install and execute modified versions of a covered work in that User Product from a modified version of its Corresponding Source. The information must suffice to ensure that the continued functioning of the modified object code is in no case prevented or interfered with solely because modification has been made.

If you convey an object code work under this section in, or with, or specifically for use in, a User Product, and the conveying occurs as part of a transaction in which the right of possession and use of the User Product is transferred to the recipient in perpetuity or for a fixed term (regardless of how the transaction is characterized), the Corresponding Source conveyed under this section must be accompanied by the Installation Information. But this requirement does not apply if neither you nor any third party retains the ability to install modified object code on the User Product (for example, the work has been installed in ROM).

The requirement to provide Installation Information does not include a requirement to continue to provide support service, warranty, or updates for a work that has been modified or installed by the recipient, or for the User Product in which it has been modified or installed. Access to a network may be denied when the modification itself materially and adversely affects the operation of the network or violates the rules and protocols for communication across the network.

Corresponding Source conveyed, and Installation Information provided, in accord with this section must be in a format that is publicly documented (and with an implementation available to the public in source code form), and must require no special password or key for unpacking, reading or copying.

7. Additional Terms.

"Additional permissions" are terms that supplement the terms of this License by making exceptions from one or more of its conditions. Additional permissions that are applicable to the entire Program shall be treated as though they were included in this License, to the extent that they are valid under applicable law. If additional permissions apply only to part of the Program, that part may be used separately under those permissions, but the entire Program remains governed by this License without regard to the additional permissions.

When you convey a copy of a covered work, you may at your option remove any additional permissions from that copy, or from any part of it. (Additional permissions may be written to require their own removal in certain cases when you modify the work.) You may place additional permissions on material, added by you to a covered work, for which you have or can give appropriate copyright permission.

Notwithstanding any other provision of this License, for material you add to a covered work, you may (if authorized by the copyright holders of that material) supplement the terms of this License with terms:

a) Disclaiming warranty or limiting liability differently from the terms of sections 15 and 16 of this License; or

b) Requiring preservation of specified reasonable legal notices or author attributions in that material or in the Appropriate Legal Notices displayed by works containing it; or

c) Prohibiting misrepresentation of the origin of that material, or requiring that modified versions of such material be marked in reasonable ways as different from the original version; or

d) Limiting the use for publicity purposes of names of licensors or authors of the material; or

e) Declining to grant rights under trademark law for use of some trade names, trademarks, or service marks; or

f) Requiring indemnification of licensors and authors of that material by anyone who conveys the material (or modified versions of it) with contractual assumptions of liability to the recipient, for any liability that these contractual assumptions directly impose on those licensors and authors.

All other non-permissive additional terms are considered "further restrictions" within the meaning of section 10. If the Program as you received it, or any part of it, contains a notice stating that it is governed by this License along with a term that is a further restriction, you may remove that term. If a license document contains a further restriction but permits relicensing or conveying under this License, you may add to a covered work material governed by the terms of that license document, provided that the further restriction does not survive such relicensing or conveying.

If you add terms to a covered work in accord with this section, you must place, in the relevant source files, a statement of the additional terms that apply to those files, or a notice indicating where to find the applicable terms.

Additional terms, permissive or non-permissive, may be stated in the form of a separately written license, or stated as exceptions; the above requirements apply either way.

8. Termination.

You may not propagate or modify a covered work except as expressly provided under this License. Any attempt otherwise to propagate or modify it is void, and will automatically terminate your rights under this License (including any patent licenses granted under the third paragraph of section 11).

However, if you cease all violation of this License, then your license from a particular copyright holder is reinstated (a) provisionally, unless and until the copyright holder explicitly and finally terminates your license, and (b) permanently, if the copyright holder fails to notify you of the violation by some reasonable means prior to 60 days after the cessation.

Moreover, your license from a particular copyright holder is reinstated permanently if the copyright holder notifies you of the violation by some reasonable means, this is the first time you have received notice of violation of this License (for any work) from that copyright holder, and you cure the violation prior to 30 days after your receipt of the notice.

Termination of your rights under this section does not terminate the licenses of parties who have received copies or rights from you under this License. If your rights have been terminated and not permanently reinstated, you do not qualify to receive new licenses for the same material under section 10.

9. Acceptance Not Required for Having Copies.

You are not required to accept this License in order to receive or run a copy of the Program. Ancillary propagation of a covered work occurring solely as a consequence of using peer-to-peer transmission to receive a copy likewise does not require acceptance. However, nothing other than this License grants you

permission to propagate or modify any covered work. These actions infringe copyright if you do not accept this License. Therefore, by modifying or propagating a covered work, you indicate your acceptance of this License to do so.

10. Automatic Licensing of Downstream Recipients.

Each time you convey a covered work, the recipient automatically receives a license from the original licensors, to run, modify and propagate that work, subject to this License. You are not responsible for enforcing compliance by third parties with this License.

An "entity transaction" is a transaction transferring control of an organization, or substantially all assets of one, or subdividing an organization, or merging organizations. If propagation of a covered work results from an entity transaction, each party to that transaction who receives a copy of the work also receives whatever licenses to the work the party's predecessor in interest had or could give under the previous paragraph, plus a right to possession of the Corresponding Source of the work from the predecessor in interest, if the predecessor has it or can get it with reasonable efforts.

You may not impose any further restrictions on the exercise of the rights granted or affirmed under this License. For example, you may not impose a license fee, royalty, or other charge for exercise of rights granted under this License, and you may not initiate litigation (including a cross-claim or counterclaim in a lawsuit) alleging that any patent claim is infringed by making, using, selling, offering for sale, or importing the Program or any portion of it.

11. Patents.

A "contributor" is a copyright holder who authorizes use under this License of the Program or a work on which the Program is based. The work thus licensed is called the contributor's "contributor version".

A contributor's "essential patent claims" are all patent claims owned or controlled by the contributor, whether already acquired or hereafter acquired, that would be infringed by some manner, permitted by this License, of making, using, or selling its contributor version, but do not include claims that would be infringed only as a consequence of further modification of the contributor version. For purposes of this definition, "control" includes the right to grant patent sublicenses in a manner consistent with the requirements of this License.

Each contributor grants you a non-exclusive, worldwide, royalty-free patent license under the contributor's essential patent claims, to make, use, sell, offer for sale, import and otherwise run, modify and propagate the contents of its contributor version.

In the following three paragraphs, a "patent license" is any express agreement or commitment, however denominated, not to enforce a patent (such as an express permission to practice a patent or covenant not to sue for patent infringement). To "grant" such a patent license to a party means to make such an agreement or commitment not to enforce a patent against the party.

If you convey a covered work, knowingly relying on a patent license, and the Corresponding Source of the work is not available for anyone to copy, free of charge and under the terms of this License, through a publicly available network server or other readily accessible means, then you must either (1) cause the Corresponding Source to be so available, or (2) arrange to deprive yourself of the benefit of the patent license for this particular work, or (3) arrange, in a manner consistent with the requirements of this License, to extend the patent license to downstream recipients. "Knowingly relying" means you have actual knowledge that, but for the patent license, your conveying the covered work in a country, or your recipient's use of the covered work in a country, would infringe one or more identifiable patents in that country that you have reason to believe are valid.

If, pursuant to or in connection with a single transaction or arrangement, you convey, or propagate by procuring conveyance of, a covered work, and grant a patent license to some of the parties receiving the covered work authorizing them to use, propagate, modify or convey a specific copy of the covered work, then the patent license you grant is automatically extended to all recipients of the covered work and works based on it.

A patent license is "discriminatory" if it does not include within the scope of its coverage, prohibits the exercise of, or is conditioned on the non-exercise of one or more of the rights that are specifically granted under this License. You may not convey a covered work if you are a party to an arrangement with a third party that is in the business of distributing software, under which you make payment to the third party based on the extent of your activity of conveying the work, and under which the third party grants, to any of the parties who would receive the covered work from you, a discriminatory patent license (a) in connection with copies of the covered work conveyed by you (or copies made from those copies), or (b) primarily for and in connection with specific products or compilations that contain the covered work, unless you entered into that arrangement, or that patent license was granted, prior to 28 March 2007.

Nothing in this License shall be construed as excluding or limiting any implied license or other defenses to infringement that may otherwise be available to you under applicable patent law.

12. No Surrender of Others' Freedom.

If conditions are imposed on you (whether by court order, agreement or otherwise) that contradict the conditions of this License, they do not excuse you from the conditions of this License. If you cannot convey a covered work so as to satisfy simultaneously your obligations under this License and any other pertinent obligations, then as a consequence you may not convey it at all. For example, if you agree to terms that obligate you to collect a royalty for further conveying from those to whom you convey the Program, the only way you could satisfy both those terms and this License would be to refrain entirely from conveying the Program.

13. Use with the GNU Affero General Public License.

Notwithstanding any other provision of this License, you have permission to link or combine any covered work with a work licensed under version 3 of the GNU Affero General Public License into a single combined work, and to convey the resulting work. The terms of this License will continue to apply to the part which is the covered work, but the special requirements of the GNU Affero General Public License, section 13, concerning interaction through a network will apply to the combination as such.

14. Revised Versions of this License.

The Free Software Foundation may publish revised and/or new versions of the GNU General Public License from time to time. Such new versions will be similar in spirit to the present version, but may differ in detail to address new problems or concerns.

Each version is given a distinguishing version number. If the Program specifies that a certain numbered version of the GNU General Public License "or any later version" applies to it, you have the option of following the terms and conditions either of that numbered version or of any later version published by the Free Software Foundation. If the Program does not specify a version number of the GNU General Public License, you may choose any version ever published by the Free Software Foundation.

If the Program specifies that a proxy can decide which future versions of the GNU General Public License can be used, that proxy's public statement of acceptance of a version permanently authorizes you to choose that version for the Program.

Later license versions may give you additional or different permissions. However, no additional obligations are imposed on any author or copyright holder as a result of your choosing to follow a later version.

15. Disclaimer of Warranty.

THERE IS NO WARRANTY FOR THE PROGRAM, TO THE EXTENT PERMITTED BY APPLICABLE LAW. EXCEPT WHEN OTHERWISE STATED IN WRITING THE COPYRIGHT HOLDERS AND/OR OTHER PARTIES PROVIDE THE PROGRAM "AS IS" WITHOUT WARRANTY OF ANY KIND, EITHER EXPRESSED OR IMPLIED, INCLUDING, BUT NOT LIMITED TO, THE IMPLIED WARRANTIES OF MERCHANTABILITY AND FITNESS FOR A PARTICULAR PURPOSE. THE ENTIRE RISK AS TO THE QUALITY AND PERFORMANCE OF THE PROGRAM IS WITH YOU. SHOULD THE PROGRAM PROVE DEFECTIVE, YOU ASSUME THE COST OF ALL NECESSARY SERVICING, REPAIR OR CORRECTION.

16. Limitation of Liability.

IN NO EVENT UNLESS REQUIRED BY APPLICABLE LAW OR AGREED TO IN WRITING WILL ANY COPYRIGHT HOLDER, OR ANY OTHER PARTY WHO MODIFIES AND/OR CONVEYS THE PROGRAM AS PERMITTED ABOVE, BE LIABLE TO YOU FOR DAMAGES, INCLUDING ANY GENERAL, SPECIAL, INCIDENTAL OR CONSEQUENTIAL DAMAGES ARISING OUT OF THE USE OR INABILITY TO USE THE PROGRAM (INCLUDING BUT NOT LIMITED TO LOSS OF DATA OR DATA BEING RENDERED INACCURATE OR LOSSES SUSTAINED BY YOU OR THIRD PARTIES OR A FAILURE OF THE PROGRAM TO OPERATE WITH ANY OTHER PROGRAMS), EVEN IF SUCH HOLDER OR OTHER PARTY HAS BEEN ADVISED OF THE POSSIBILITY OF SUCH DAMAGES.

17. Interpretation of Sections 15 and 16.

If the disclaimer of warranty and limitation of liability provided above cannot be given local legal effect according to their terms, reviewing courts shall apply local law that most closely approximates an absolute waiver of all civil liability in connection with the Program, unless a warranty or assumption of liability accompanies a copy of the Program in return for a fee.

END OF TERMS AND CONDITIONS

How to Apply These Terms to Your New Programs

If you develop a new program, and you want it to be of the greatest possible use to the public, the best way to achieve this is to make it free software which everyone can redistribute and change under these terms.

To do so, attach the following notices to the program. It is safest to attach them to the start of each source file to most effectively state the exclusion of warranty; and each file should have at least the "copyright" line and a pointer to where the full notice is found.

```
<one line to give the program's name and a brief idea of what it does.>
Copyright (C) <year> <name of author>
```

This program is free software: you can redistribute it and/or modify it under the terms of the GNU General Public License as published by the Free Software Foundation, either version 3 of the License, or (at your option) any later version.

This program is distributed in the hope that it will be useful, but WITHOUT ANY WARRANTY; without even the implied warranty of MERCHANTABILITY or FITNESS FOR A PARTICULAR PURPOSE. See the GNU General Public License for more details.

You should have received a copy of the GNU General Public License along with this program. If not, see <<http://www.gnu.org/licenses/>>.

Also add information on how to contact you by electronic and paper mail.

If the program does terminal interaction, make it output a short notice like this when it starts in an interactive mode:

```
<program> Copyright (C) <year> <name of author> This program comes with
ABSOLUTELY NO WARRANTY; for details type `show w'. This is free software, and
you are welcome to redistribute it under certain conditions; type `show c'
for details.
```

The hypothetical commands `show w' and `show c' should show the appropriate parts of the General Public License. Of course, your program's commands might be different; for a GUI interface, you would use an "about box".

You should also get your employer (if you work as a programmer) or school, if any, to sign a "copyright disclaimer" for the program, if necessary. For more information on this, and how to apply and follow the GNU GPL, see <<http://www.gnu.org/licenses/>>.

The GNU General Public License does not permit incorporating your program into proprietary programs. If your program is a subroutine library, you may consider it more useful to permit linking proprietary applications with the library. If this is what you want to do, use the GNU Lesser General Public License instead of this License. But first, please read <<http://www.gnu.org/philosophy/why-not-lgpl.html>>.

dhcp 4.1-ESV-R4

```
# Copyright (c) 2004-2011 by Internet Systems Consortium, Inc. ("ISC") # Copyright
(c) 1995-2003 by Internet Software Consortium # # Permission to use, copy, modify,
and distribute this software for any # purpose with or without fee is hereby
granted, provided that the above # copyright notice and this permission notice
appear in all copies. # # THE SOFTWARE IS PROVIDED "AS IS" AND ISC DISCLAIMS ALL
WARRANTIES # WITH REGARD TO THIS SOFTWARE INCLUDING ALL IMPLIED WARRANTIES OF #
MERCHANTABILITY AND FITNESS. IN NO EVENT SHALL ISC BE LIABLE FOR # ANY SPECIAL,
DIRECT, INDIRECT, OR CONSEQUENTIAL DAMAGES OR ANY DAMAGES # WHATSOEVER RESULTING
FROM LOSS OF USE, DATA OR PROFITS, WHETHER IN AN # ACTION OF CONTRACT, NEGLIGENCE
OR OTHER TORTIOUS ACTION, ARISING OUT # OF OR IN CONNECTION WITH THE USE OR
PERFORMANCE OF THIS SOFTWARE. # # Internet Systems Consortium, Inc. # 950
Charter Street # Redwood City, CA 94063 # <info@isc.org> # https://
www.isc.org/
```

e2fsprogs 1.42.2

This is the Debian GNU/Linux prepackaged version of the EXT2 file system utilities (e2fsck, mke2fs, etc.). The EXT2 utilities were written by Theodore Ts'o <tytso@mit.edu> and Remy Card <card@masi.ibp.fr>.

Sources were obtained from <http://sourceforge.net/projects/e2fsprogs>

```
Packaging is Copyright (c) 2003-2007 Theodore Ts'o <tytso@mit.edu>
Copyright (c) 1997-2003 Yann Dirson <dirson@debian.org> Copyright (c) 2001
Alcove <http://www.alcove.com/> Copyright (c) 1997 Klee Dienes
Copyright (c) 1995-1996 Michael Nonweiler <mrn20@cam.ac.uk>
```

Upstream Author: Theodore Ts'o <tytso@mit.edu>

Copyright notice:

This package, the EXT2 filesystem utilities, are made available under the GNU Public License version 2, with the exception of the lib/ext2fs and lib/e2p libraries, which are made available under the GNU Library General Public License Version 2, the lib/uuid library which is made available under a BSD-style license and the lib/et and lib/ss libraries which are made available under an MIT-style license.

Copyright (c) 1993, 1994, 1995, 1996, 1997, 1998, 1999, 2000, 2001, 2002, 2003, 2004, 2005, 2006, 2007, 2008 by Theodore Ts'o

On Debian GNU systems, the complete text of the GNU General Public License can be found in `~/usr/share/common-licenses/GPL-2`. The complete text of the GNU Library General Public License can be found in `~/usr/share/common-licenses/LGPL-2`.

The license used for lib/et and lib/ss libraries is:

Copyright 1987 by the Student Information Processing Board of the Massachusetts Institute of Technology

Permission to use, copy, modify, and distribute this software and its documentation for any purpose is hereby granted, provided that the names of M.I.T. and the M.I.T. S.I.P.B. not be used in advertising or publicity pertaining to distribution of the software without specific, written prior permission. M.I.T. and the M.I.T. S.I.P.B. make no representations about the suitability of this software for any purpose. It is provided "as is" without express or implied warranty.

The license used for lib/uuid is:

Redistribution and use in source and binary forms, with or without modification, are permitted provided that the following conditions are met:

1. Redistributions of source code must retain the above copyright notice, and the entire permission notice in its entirety, including the disclaimer of warranties.
2. Redistributions in binary form must reproduce the above copyright notice, this list of conditions and the following disclaimer in the documentation and/or other materials provided with the distribution.
3. The name of the author may not be used to endorse or promote products derived from this software without specific prior written permission.

THIS SOFTWARE IS PROVIDED ``AS IS'' AND ANY EXPRESS OR IMPLIED WARRANTIES, INCLUDING BUT NOT LIMITED TO, THE IMPLIED WARRANTIES OF MERCHANTABILITY AND FITNESS FOR A PARTICULAR PURPOSE, ALL OF WHICH ARE HEREBY DISCLAIMED. IN NO EVENT SHALL THE AUTHOR BE LIABLE FOR ANY DIRECT, INDIRECT, INCIDENTAL, SPECIAL, EXEMPLARY, OR CONSEQUENTIAL DAMAGES (INCLUDING, BUT NOT LIMITED TO, PROCUREMENT OF SUBSTITUTE GOODS OR SERVICES; LOSS OF USE, DATA, OR PROFITS; OR BUSINESS INTERRUPTION) HOWEVER CAUSED AND ON ANY THEORY OF LIABILITY, WHETHER IN CONTRACT, STRICT LIABILITY, OR TORT (INCLUDING NEGLIGENCE OR OTHERWISE) ARISING IN ANY WAY OUT OF THE USE OF THIS SOFTWARE, EVEN IF NOT ADVISED OF THE POSSIBILITY OF SUCH DAMAGE.

expat 2.1.0

Copyright (c) 1998, 1999, 2000 Thai Open Source Software Center Ltd and Clark Cooper Copyright (c) 2001, 2002, 2003, 2004, 2005, 2006 Expat maintainers.

Permission is hereby granted, free of charge, to any person obtaining a copy of this software and associated documentation files (the "Software"), to deal in the Software without restriction, including without limitation the rights to use, copy, modify, merge, publish, distribute, sublicense, and/or sell copies of the Software, and to permit persons to whom the Software is furnished to do so, subject to the following conditions:

The above copyright notice and this permission notice shall be included in all copies or substantial portions of the Software.

THE SOFTWARE IS PROVIDED "AS IS", WITHOUT WARRANTY OF ANY KIND, EXPRESS OR IMPLIED, INCLUDING BUT NOT LIMITED TO THE WARRANTIES OF MERCHANTABILITY, FITNESS FOR A PARTICULAR PURPOSE AND NONINFRINGEMENT. IN NO EVENT SHALL THE AUTHORS OR COPYRIGHT HOLDERS BE LIABLE FOR ANY CLAIM, DAMAGES OR OTHER LIABILITY, WHETHER IN AN ACTION OF CONTRACT, TORT OR OTHERWISE, ARISING FROM, OUT OF OR IN CONNECTION WITH THE SOFTWARE OR THE USE OR OTHER DEALINGS IN THE SOFTWARE.

gcc-library 4.7.2

GNU LESSER GENERAL PUBLIC LICENSE

Version

2.1, February 1999

Copyright (C) 1991, 1999 Free Software Foundation, Inc. 51 Franklin St, Fifth Floor, Boston, MA 02110-1301 USA Everyone is permitted to copy and distribute verbatim copies of this license document, but changing it is not allowed.

[This is the first released version of the Lesser GPL. It also counts as the successor of the GNU Library Public License, version 2, hence the version number 2.1.]

Preamble

The licenses for most software are designed to take away your freedom to share and change it. By contrast, the GNU General Public Licenses are intended to guarantee your freedom to share and change free software--to make sure the software is free for all its users.

This license, the Lesser General Public License, applies to some specially designated software packages--typically libraries--of the Free Software Foundation and other authors who decide to use it. You can use it too, but we suggest you first think carefully about whether this license or the ordinary General Public License is the better strategy to use in any particular case, based on the explanations below.

When we speak of free software, we are referring to freedom of use, not price. Our General Public Licenses are designed to make sure that you have the freedom to distribute copies of free software (and charge for this service if you wish); that you receive source code or can get it if you want it; that you can change the software and use pieces of it in new free programs; and that you are informed that you can do these things.

To protect your rights, we need to make restrictions that forbid distributors to deny you these rights or to ask you to surrender these rights. These restrictions translate to certain responsibilities for you if you distribute copies of the library or if you modify it.

For example, if you distribute copies of the library, whether gratis or for a fee, you must give the recipients all the rights that we gave you. You must make sure that they, too, receive or can get the source code. If you link other code with the library, you must provide complete object files to the recipients, so that they can relink them with the library after making changes to the library and recompiling it. And you must show them these terms so they know their rights.

We protect your rights with a two-step method: (1) we copyright the library, and (2) we offer you this license, which gives you legal permission to copy, distribute and/or modify the library.

To protect each distributor, we want to make it very clear that there is no warranty for the free library. Also, if the library is modified by someone else and passed on, the recipients should know that what they have is not the original version, so that the original author's reputation will not be affected by problems that might be introduced by others.

Finally, software patents pose a constant threat to the existence of any free program. We wish to make sure that a company cannot effectively restrict the users of a free program by obtaining a restrictive license from a patent holder. Therefore, we insist that any patent license obtained for a version of the library must be consistent with the full freedom of use specified in this license.

Most GNU software, including some libraries, is covered by the ordinary GNU General Public License. This license, the GNU Lesser General Public License, applies to certain designated libraries, and is quite different from the ordinary General Public License. We use this license for certain libraries in order to permit linking those libraries into non-free programs.

When a program is linked with a library, whether statically or using a shared library, the combination of the two is legally speaking a combined work, a derivative of the original library. The ordinary General Public License therefore permits such linking only if the entire combination fits its criteria of freedom. The Lesser General Public License permits more lax criteria for linking other code with the library.

We call this license the "Lesser" General Public License because it does Less to protect the user's freedom than the ordinary General Public License. It also provides other free software developers Less of an advantage over competing non-free programs. These disadvantages are the reason we use the ordinary General Public License for many libraries. However, the Lesser license provides advantages in certain special circumstances.

For example, on rare occasions, there may be a special need to encourage the widest possible use of a certain library, so that it becomes a de-facto standard. To achieve this, non-free programs must be allowed to use the library. A more frequent case is that a free library does the same job as widely used non-free libraries. In this case, there is little to gain by limiting the free library to free software only, so we use the Lesser General Public License.

In other cases, permission to use a particular library in non-free programs enables a greater number of people to use a large body of free software. For example, permission to use the GNU C Library in non-free programs enables many more people to use the whole GNU operating system, as well as its variant, the GNU/Linux operating system.

Although the Lesser General Public License is Less protective of the users' freedom, it does ensure that the user of a program that is linked with the Library has the freedom and the wherewithal to run that program using a modified version of the Library.

The precise terms and conditions for copying, distribution and modification follow. Pay close attention to the difference between a "work based on the library" and a "work that uses the library". The former contains code derived from the library, whereas the latter must be combined with the library in order to run.

GNU LESSER GENERAL PUBLIC LICENSE
TERMS AND CONDITIONS FOR COPYING, DISTRIBUTION AND MODIFICATION

0. This License Agreement applies to any software library or other program which contains a notice placed by the copyright holder or other authorized party saying it may be distributed under the terms of this Lesser General Public License (also called "this License"). Each licensee is addressed as "you".

A "library" means a collection of software functions and/or data prepared so as to be conveniently linked with application programs (which use some of those functions and data) to form executables.

The "Library", below, refers to any such software library or work which has been distributed under these terms. A "work based on the Library" means either the Library or any derivative work under copyright law: that is to say, a work containing the Library or a portion of it, either verbatim or with modifications and/or translated straightforwardly into another language. (Hereinafter, translation is included without limitation in the term "modification".)

"Source code" for a work means the preferred form of the work for making modifications to it. For a library, complete source code means all the source code for all modules it contains, plus any associated interface definition files, plus the scripts used to control compilation and installation of the library.

Activities other than copying, distribution and modification are not covered by this License; they are outside its scope. The act of running a program using the Library is not restricted, and output from such a program is covered only if its

contents constitute a work based on the Library (independent of the use of the Library in a tool for writing it). Whether that is true depends on what the Library does and what the program that uses the Library does.

1. You may copy and distribute verbatim copies of the Library's complete source code as you receive it, in any medium, provided that you conspicuously and appropriately publish on each copy an appropriate copyright notice and disclaimer of warranty; keep intact all the notices that refer to this License and to the absence of any warranty; and distribute a copy of this License along with the Library.

You may charge a fee for the physical act of transferring a copy, and you may at your option offer warranty protection in exchange for a fee.

2. You may modify your copy or copies of the Library or any portion of it, thus forming a work based on the Library, and copy and distribute such modifications or work under the terms of Section 1 above, provided that you also meet all of these conditions:

a) The modified work must itself be a software library.

b) You must cause the files modified to carry prominent notices stating that you changed the files and the date of any change.

c) You must cause the whole of the work to be licensed at no charge to all third parties under the terms of this License.

d) If a facility in the modified Library refers to a function or a table of data to be supplied by an application program that uses the facility, other than as an argument passed when the facility is invoked, then you must make a good faith effort to ensure that, in the event an application does not supply such function or table, the facility still operates, and performs whatever part of its purpose remains meaningful.

(For example, a function in a library to compute square roots has a purpose that is entirely well-defined independent of the application. Therefore, Subsection 2d requires that any application-supplied function or table used by this function must be optional: if the application does not supply it, the square root function must still compute square roots.)

These requirements apply to the modified work as a whole. If identifiable sections of that work are not derived from the Library, and can be reasonably considered independent and separate works in themselves, then this License, and its terms, do not apply to those sections when you distribute them as separate works. But when you distribute the same sections as part of a whole which is a work based on the Library, the distribution of the whole must be on the terms of this License, whose permissions for other licensees extend to the entire whole, and thus to each and every part regardless of who wrote it.

Thus, it is not the intent of this section to claim rights or contest your rights to work written entirely by you; rather, the intent is to exercise the right to control the distribution of derivative or collective works based on the Library.

In addition, mere aggregation of another work not based on the Library with the Library (or with a work based on the Library) on a volume of a storage or distribution medium does not bring the other work under the scope of this License.

3. You may opt to apply the terms of the ordinary GNU General Public License instead of this License to a given copy of the Library. To do this, you must alter all the notices that refer to this License, so that they refer to the ordinary GNU General Public License, version 2, instead of to this License. (If a newer version than version 2 of the ordinary GNU General Public License has appeared, then you can specify that version instead if you wish.) Do not make any other change in these notices.

Once this change is made in a given copy, it is irreversible for that copy, so the ordinary GNU General Public License applies to all subsequent copies and derivative works made from that copy.

This option is useful when you wish to copy part of the code of the Library into a program that is not a library.

4. You may copy and distribute the Library (or a portion or derivative of it, under Section 2) in object code or executable form under the terms of Sections 1 and 2 above provided that you accompany it with the complete corresponding machine-readable source code, which must be distributed under the terms of Sections 1 and 2 above on a medium customarily used for software interchange.

If distribution of object code is made by offering access to copy from a designated place, then offering equivalent access to copy the source code from the same place satisfies the requirement to distribute the source code, even though third parties are not compelled to copy the source along with the object code.

5. A program that contains no derivative of any portion of the Library, but is designed to work with the Library by being compiled or linked with it, is called a "work that uses the Library". Such a work, in isolation, is not a derivative work of the Library, and therefore falls outside the scope of this License.

However, linking a "work that uses the Library" with the Library creates an executable that is a derivative of the Library (because it contains portions of the Library), rather than a "work that uses the library". The executable is therefore covered by this License. Section 6 states terms for distribution of such executables.

When a "work that uses the Library" uses material from a header file that is part of the Library, the object code for the work may be a derivative work of the Library even though the source code is not. Whether this is true is especially significant if the work can be linked without the Library, or if the work is itself a library. The threshold for this to be true is not precisely defined by law.

If such an object file uses only numerical parameters, data structure layouts and accessors, and small macros and small inline functions (ten lines or less in length), then the use of the object file is unrestricted, regardless of whether it is legally a derivative work. (Executables containing this object code plus portions of the Library will still fall under Section 6.)

Otherwise, if the work is a derivative of the Library, you may distribute the object code for the work under the terms of Section 6. Any executables containing that work also fall under Section 6, whether or not they are linked directly with the Library itself.

6. As an exception to the Sections above, you may also combine or link a "work that uses the Library" with the Library to produce a work containing portions of the Library, and distribute that work under terms of your choice, provided that the terms permit modification of the work for the customer's own use and reverse engineering for debugging such modifications.

You must give prominent notice with each copy of the work that the Library is used in it and that the Library and its use are covered by this License. You must supply a copy of this License. If the work during execution displays copyright notices, you must include the copyright notice for the Library among them, as well as a reference directing the user to the copy of this License. Also, you must do one of these things:

a) Accompany the work with the complete corresponding machine-readable source code for the Library including whatever changes were used in the work (which must be distributed under Sections 1 and 2 above); and, if the work is an executable linked with the Library, with the complete machine-readable "work that uses the Library", as object code and/or source code, so that the user can modify the Library and then relink to produce a modified executable

containing the modified Library. (It is understood that the user who changes the contents of definitions files in the Library will not necessarily be able to recompile the application to use the modified definitions.)

b) Use a suitable shared library mechanism for linking with the Library. A suitable mechanism is one that (1) uses at run time a copy of the library already present on the user's computer system, rather than copying library functions into the executable, and (2) will operate properly with a modified version of the library, if the user installs one, as long as the modified version is interface-compatible with the version that the work was made with.

c) Accompany the work with a written offer, valid for at least three years, to give the same user the materials specified in Subsection 6a, above, for a charge no more than the cost of performing this distribution.

d) If distribution of the work is made by offering access to copy from a designated place, offer equivalent access to copy the above specified materials from the same place.

e) Verify that the user has already received a copy of these materials or that you have already sent this user a copy.

For an executable, the required form of the "work that uses the Library" must include any data and utility programs needed for reproducing the executable from it. However, as a special exception, the materials to be distributed need not include anything that is normally distributed (in either source or binary form) with the major components (compiler, kernel, and so on) of the operating system on which the executable runs, unless that component itself accompanies the executable.

It may happen that this requirement contradicts the license restrictions of other proprietary libraries that do not normally accompany the operating system. Such a contradiction means you cannot use both them and the Library together in an executable that you distribute.

7. You may place library facilities that are a work based on the Library side-by-side in a single library together with other library facilities not covered by this License, and distribute such a combined library, provided that the separate distribution of the work based on the Library and of the other library facilities is otherwise permitted, and provided that you do these two things:

a) Accompany the combined library with a copy of the same work based on the Library, uncombined with any other library facilities. This must be distributed under the terms of the Sections above.

b) Give prominent notice with the combined library of the fact that part of it is a work based on the Library, and explaining where to find the accompanying uncombined form of the same work.

8. You may not copy, modify, sublicense, link with, or distribute the Library except as expressly provided under this License. Any attempt otherwise to copy, modify, sublicense, link with, or distribute the Library is void, and will automatically terminate your rights under this License. However, parties who have received copies, or rights, from you under this License will not have their licenses terminated so long as such parties remain in full compliance.

9. You are not required to accept this License, since you have not signed it. However, nothing else grants you permission to modify or distribute the Library or its derivative works. These actions are prohibited by law if you do not accept this License. Therefore, by modifying or distributing the Library (or any work based on the Library), you indicate your acceptance of this License to do so, and all its terms and conditions for copying, distributing or modifying the Library or works based on it.

10. Each time you redistribute the Library (or any work based on the Library), the recipient automatically receives a license from the original licensor to copy, distribute, link with or modify the Library subject to these terms and conditions.

You may not impose any further restrictions on the recipients' exercise of the rights granted herein. You are not responsible for enforcing compliance by third parties with this License.

11. If, as a consequence of a court judgment or allegation of patent infringement or for any other reason (not limited to patent issues), conditions are imposed on you (whether by court order, agreement or otherwise) that contradict the conditions of this License, they do not excuse you from the conditions of this License. If you cannot distribute so as to satisfy simultaneously your obligations under this License and any other pertinent obligations, then as a consequence you may not distribute the Library at all. For example, if a patent license would not permit royalty-free redistribution of the Library by all those who receive copies directly or indirectly through you, then the only way you could satisfy both it and this License would be to refrain entirely from distribution of the Library.

If any portion of this section is held invalid or unenforceable under any particular circumstance, the balance of the section is intended to apply, and the section as a whole is intended to apply in other circumstances.

It is not the purpose of this section to induce you to infringe any patents or other property right claims or to contest validity of any such claims; this section has the sole purpose of protecting the integrity of the free software distribution system which is implemented by public license practices. Many people have made generous contributions to the wide range of software distributed through that system in reliance on consistent application of that system; it is up to the author/donor to decide if he or she is willing to distribute software through any other system and a licensee cannot impose that choice.

This section is intended to make thoroughly clear what is believed to be a consequence of the rest of this License.

12. If the distribution and/or use of the Library is restricted in certain countries either by patents or by copyrighted interfaces, the original copyright holder who places the Library under this License may add an explicit geographical distribution limitation excluding those countries, so that distribution is permitted only in or among countries not thus excluded. In such case, this License incorporates the limitation as if written in the body of this License.

13. The Free Software Foundation may publish revised and/or new versions of the Lesser General Public License from time to time. Such new versions will be similar in spirit to the present version, but may differ in detail to address new problems or concerns.

Each version is given a distinguishing version number. If the Library specifies a version number of this License which applies to it and "any later version", you have the option of following the terms and conditions either of that version or of any later version published by the Free Software Foundation. If the Library does not specify a license version number, you may choose any version ever published by the Free Software Foundation.

14. If you wish to incorporate parts of the Library into other free programs whose distribution conditions are incompatible with these, write to the author to ask for permission. For software which is copyrighted by the Free Software Foundation, write to the Free Software Foundation; we sometimes make exceptions for this. Our decision will be guided by the two goals of preserving the free status of all derivatives of our free software and of promoting the sharing and reuse of software generally.

NO WARRANTY

15. BECAUSE THE LIBRARY IS LICENSED FREE OF CHARGE, THERE IS NO WARRANTY FOR THE LIBRARY, TO THE EXTENT PERMITTED BY APPLICABLE LAW. EXCEPT WHEN OTHERWISE STATED IN WRITING THE COPYRIGHT HOLDERS AND/OR OTHER PARTIES PROVIDE THE LIBRARY "AS IS" WITHOUT WARRANTY OF ANY KIND, EITHER EXPRESSED OR IMPLIED, INCLUDING, BUT NOT LIMITED TO, THE IMPLIED WARRANTIES OF MERCHANTABILITY AND FITNESS FOR A

PARTICULAR PURPOSE. THE ENTIRE RISK AS TO THE QUALITY AND PERFORMANCE OF THE LIBRARY IS WITH YOU. SHOULD THE LIBRARY PROVE DEFECTIVE, YOU ASSUME THE COST OF ALL NECESSARY SERVICING, REPAIR OR CORRECTION.

16. IN NO EVENT UNLESS REQUIRED BY APPLICABLE LAW OR AGREED TO IN WRITING WILL ANY COPYRIGHT HOLDER, OR ANY OTHER PARTY WHO MAY MODIFY AND/OR REDISTRIBUTE THE LIBRARY AS PERMITTED ABOVE, BE LIABLE TO YOU FOR DAMAGES, INCLUDING ANY GENERAL, SPECIAL, INCIDENTAL OR CONSEQUENTIAL DAMAGES ARISING OUT OF THE USE OR INABILITY TO USE THE LIBRARY (INCLUDING BUT NOT LIMITED TO LOSS OF DATA OR DATA BEING RENDERED INACCURATE OR LOSSES SUSTAINED BY YOU OR THIRD PARTIES OR A FAILURE OF THE LIBRARY TO OPERATE WITH ANY OTHER SOFTWARE), EVEN IF SUCH HOLDER OR OTHER PARTY HAS BEEN ADVISED OF THE POSSIBILITY OF SUCH DAMAGES.

END OF TERMS AND CONDITIONS

How to Apply These Terms to Your New Libraries

If you develop a new library, and you want it to be of the greatest possible use to the public, we recommend making it free software that everyone can redistribute and change. You can do so by permitting redistribution under these terms (or, alternatively, under the terms of the ordinary General Public License).

To apply these terms, attach the following notices to the library. It is safest to attach them to the start of each source file to most effectively convey the exclusion of warranty; and each file should have at least the "copyright" line and a pointer to where the full notice is found.

```
<one line to give the library's name and a brief idea of what it does.>
Copyright (C) <year> <name of author>
```

This library is free software; you can redistribute it and/or modify it under the terms of the GNU Lesser General Public License as published by the Free Software Foundation; either version 2.1 of the License, or (at your option) any later version.

This library is distributed in the hope that it will be useful, but WITHOUT ANY WARRANTY; without even the implied warranty of MERCHANTABILITY or FITNESS FOR A PARTICULAR PURPOSE. See the GNU Lesser General Public License for more details.

You should have received a copy of the GNU Lesser General Public License along with this library; if not, write to the Free Software Foundation, Inc., 51 Franklin St, Fifth Floor, Boston, MA 02110-1301 USA

Also add information on how to contact you by electronic and paper mail.

You should also get your employer (if you work as a programmer) or your school, if any, to sign a "copyright disclaimer" for the library, if necessary. Here is a sample; alter the names:

```
Yoyodyne, Inc., hereby disclaims all copyright interest in the library `Frob'
(a library for tweaking knobs) written by James Random Hacker.
```

```
<signature of Ty Coon>, 1 April 1990 Ty Coon, President of Vice
```

That's all there is to it!

gcc-runtime-library 4.7.2

GCC RUNTIME LIBRARY EXCEPTION

Version 3.1, 31 March 2009

Copyright (C) 2009 Free Software Foundation, Inc. <<http://fsf.org/>>

Everyone is permitted to copy and distribute verbatim copies of this license document, but changing it is not allowed.

This GCC Runtime Library Exception ("Exception") is an additional permission under section 7 of the GNU General Public License, version 3 ("GPLv3"). It applies to a given file (the "Runtime Library") that bears a notice placed by the copyright holder of the file stating that the file is governed by GPLv3 along with this Exception.

When you use GCC to compile a program, GCC may combine portions of certain GCC header files and runtime libraries with the compiled program. The purpose of this Exception is to allow compilation of non-GPL (including proprietary) programs to use, in this way, the header files and runtime libraries covered by this Exception.

0. Definitions.

A file is an "Independent Module" if it either requires the Runtime Library for execution after a Compilation Process, or makes use of an interface provided by the Runtime Library, but is not otherwise based on the Runtime Library.

"GCC" means a version of the GNU Compiler Collection, with or without modifications, governed by version 3 (or a specified later version) of the GNU General Public License (GPL) with the option of using any subsequent versions published by the FSF.

"GPL-compatible Software" is software whose conditions of propagation, modification and use would permit combination with GCC in accord with the license of GCC.

"Target Code" refers to output from any compiler for a real or virtual target processor architecture, in executable form or suitable for input to an assembler, loader, linker and/or execution phase. Notwithstanding that, Target Code does not include data in any format that is used as a compiler intermediate representation, or used for producing a compiler intermediate representation.

The "Compilation Process" transforms code entirely represented in non-intermediate languages designed for human-written code, and/or in Java Virtual Machine byte code, into Target Code. Thus, for example, use of source code generators and preprocessors need not be considered part of the Compilation Process, since the Compilation Process can be understood as starting with the output of the generators or preprocessors.

A Compilation Process is "Eligible" if it is done using GCC, alone or with other GPL-compatible software, or if it is done without using any work based on GCC. For example, using non-GPL-compatible Software to optimize any GCC intermediate representations would not qualify as an Eligible Compilation Process.

1. Grant of Additional Permission.

You have permission to propagate a work of Target Code formed by combining the Runtime Library with Independent Modules, even if such propagation would otherwise violate the terms of GPLv3, provided that all Target Code was generated by Eligible Compilation Processes. You may then convey such a combination under terms of your choice, consistent with the licensing of the Independent Modules.

2. No Weakening of GCC Copyleft.

The availability of this Exception does not imply any general presumption that third-party software is unaffected by the copyleft requirements of the license of GCC.

gzip 1.4

GNU GENERAL PUBLIC LICENSE
Version 3, 29 June 2007

Copyright (C) 2007 Free Software Foundation, Inc. <<http://fsf.org/>> Everyone is permitted to copy and distribute verbatim copies of this license document, but changing it is not allowed.

Preamble

The GNU General Public License is a free, copyleft license for software and other kinds of works.

The licenses for most software and other practical works are designed to take away your freedom to share and change the works. By contrast, the GNU General Public License is intended to guarantee your freedom to share and change all versions of a program--to make sure it remains free software for all its users. We, the Free Software Foundation, use the GNU General Public License for most of our software; it applies also to any other work released this way by its authors. You can apply it to your programs, too.

When we speak of free software, we are referring to freedom, not price. Our General Public Licenses are designed to make sure that you have the freedom to distribute copies of free software (and charge for them if you wish), that you receive source code or can get it if you want it, that you can change the software or use pieces of it in new free programs, and that you know you can do these things.

To protect your rights, we need to prevent others from denying you these rights or asking you to surrender the rights. Therefore, you have certain responsibilities if you distribute copies of the software, or if you modify it: responsibilities to respect the freedom of others.

For example, if you distribute copies of such a program, whether gratis or for a fee, you must pass on to the recipients the same freedoms that you received. You must make sure that they, too, receive or can get the source code. And you must show them these terms so they know their rights.

Developers that use the GNU GPL protect your rights with two steps: (1) assert copyright on the software, and (2) offer you this License giving you legal permission to copy, distribute and/or modify it.

For the developers' and authors' protection, the GPL clearly explains that there is no warranty for this free software. For both users' and authors' sake, the GPL requires that modified versions be marked as changed, so that their problems will not be attributed erroneously to authors of previous versions.

Some devices are designed to deny users access to install or run modified versions of the software inside them, although the manufacturer can do so. This is fundamentally incompatible with the aim of protecting users' freedom to change the software. The systematic pattern of such abuse occurs in the area of products for individuals to use, which is precisely where it is most unacceptable. Therefore, we have designed this version of the GPL to prohibit the practice for those products. If such problems arise substantially in other domains, we stand ready to extend this provision to those domains in future versions of the GPL, as needed to protect the freedom of users.

Finally, every program is threatened constantly by software patents. States should not allow patents to restrict development and use of software on general-purpose computers, but in those that do, we wish to avoid the special danger that patents applied to a free program could make it effectively proprietary. To prevent this, the GPL assures that patents cannot be used to render the program non-free.

The precise terms and conditions for copying, distribution and modification follow.

TERMS AND CONDITIONS

0. Definitions.

"This License" refers to version 3 of the GNU General Public License.

"Copyright" also means copyright-like laws that apply to other kinds of works, such as semiconductor masks.

"The Program" refers to any copyrightable work licensed under this License. Each licensee is addressed as "you". "Licensees" and "recipients" may be individuals or organizations.

To "modify" a work means to copy from or adapt all or part of the work in a fashion requiring copyright permission, other than the making of an exact copy. The resulting work is called a "modified version" of the earlier work or a work "based on" the earlier work.

A "covered work" means either the unmodified Program or a work based on the Program.

To "propagate" a work means to do anything with it that, without permission, would make you directly or secondarily liable for infringement under applicable copyright law, except executing it on a computer or modifying a private copy. Propagation includes copying, distribution (with or without modification), making available to the public, and in some countries other activities as well.

To "convey" a work means any kind of propagation that enables other parties to make or receive copies. Mere interaction with a user through a computer network, with no transfer of a copy, is not conveying.

An interactive user interface displays "Appropriate Legal Notices" to the extent that it includes a convenient and prominently visible feature that (1) displays an appropriate copyright notice, and (2) tells the user that there is no warranty for the work (except to the extent that warranties are provided), that licensees may convey the work under this License, and how to view a copy of this License. If the interface presents a list of user commands or options, such as a menu, a prominent item in the list meets this criterion.

1. Source Code.

The "source code" for a work means the preferred form of the work for making modifications to it. "Object code" means any non-source form of a work.

A "Standard Interface" means an interface that either is an official standard defined by a recognized standards body, or, in the case of interfaces specified for a particular programming language, one that is widely used among developers working in that language.

The "System Libraries" of an executable work include anything, other than the work as a whole, that (a) is included in the normal form of packaging a Major Component, but which is not part of that Major Component, and (b) serves only to enable use of the work with that Major Component, or to implement a Standard Interface for which an implementation is available to the public in source code form. A "Major Component", in this context, means a major essential component (kernel, window system, and so on) of the specific operating system (if any) on which the executable work runs, or a compiler used to produce the work, or an object code interpreter used to run it.

The "Corresponding Source" for a work in object code form means all the source code needed to generate, install, and (for an executable work) run the object code and to modify the work, including scripts to control those activities. However, it does not include the work's System Libraries, or general-purpose tools or generally available free programs which are used unmodified in performing those activities but which are not part of the work. For example, Corresponding Source includes interface definition files associated with source files for the work, and the source code for shared libraries and dynamically linked subprograms that

the work is specifically designed to require, such as by intimate data communication or control flow between those subprograms and other parts of the work.

The Corresponding Source need not include anything that users can regenerate automatically from other parts of the Corresponding Source.

The Corresponding Source for a work in source code form is that same work.

2. Basic Permissions.

All rights granted under this License are granted for the term of copyright on the Program, and are irrevocable provided the stated conditions are met. This License explicitly affirms your unlimited permission to run the unmodified Program. The output from running a covered work is covered by this License only if the output, given its content, constitutes a covered work. This License acknowledges your rights of fair use or other equivalent, as provided by copyright law.

You may make, run and propagate covered works that you do not convey, without conditions so long as your license otherwise remains in force. You may convey covered works to others for the sole purpose of having them make modifications exclusively for you, or provide you with facilities for running those works, provided that you comply with the terms of this License in conveying all material for which you do not control copyright. Those thus making or running the covered works for you must do so exclusively on your behalf, under your direction and control, on terms that prohibit them from making any copies of your copyrighted material outside their relationship with you.

Conveying under any other circumstances is permitted solely under the conditions stated below. Sublicensing is not allowed; section 10 makes it unnecessary.

3. Protecting Users' Legal Rights From Anti-Circumvention Law.

No covered work shall be deemed part of an effective technological measure under any applicable law fulfilling obligations under article 11 of the WIPO copyright treaty adopted on 20 December 1996, or similar laws prohibiting or restricting circumvention of such measures.

When you convey a covered work, you waive any legal power to forbid circumvention of technological measures to the extent such circumvention is effected by exercising rights under this License with respect to the covered work, and you disclaim any intention to limit operation or modification of the work as a means of enforcing, against the work's users, your or third parties' legal rights to forbid circumvention of technological measures.

4. Conveying Verbatim Copies.

You may convey verbatim copies of the Program's source code as you receive it, in any medium, provided that you conspicuously and appropriately publish on each copy an appropriate copyright notice; keep intact all notices stating that this License and any non-permissive terms added in accord with section 7 apply to the code; keep intact all notices of the absence of any warranty; and give all recipients a copy of this License along with the Program.

You may charge any price or no price for each copy that you convey, and you may offer support or warranty protection for a fee.

5. Conveying Modified Source Versions.

You may convey a work based on the Program, or the modifications to produce it from the Program, in the form of source code under the terms of section 4, provided that you also meet all of these conditions:

a) The work must carry prominent notices stating that you modified it, and giving a relevant date.

b) The work must carry prominent notices stating that it is released under this License and any conditions added under section 7. This requirement modifies the requirement in section 4 to "keep intact all notices".

c) You must license the entire work, as a whole, under this License to anyone who comes into possession of a copy. This License will therefore apply, along with any applicable section 7 additional terms, to the whole of the work, and all its parts, regardless of how they are packaged. This License gives no permission to license the work in any other way, but it does not invalidate such permission if you have separately received it.

d) If the work has interactive user interfaces, each must display Appropriate Legal Notices; however, if the Program has interactive interfaces that do not display Appropriate Legal Notices, your work need not make them do so.

A compilation of a covered work with other separate and independent works, which are not by their nature extensions of the covered work, and which are not combined with it such as to form a larger program, in or on a volume of a storage or distribution medium, is called an "aggregate" if the compilation and its resulting copyright are not used to limit the access or legal rights of the compilation's users beyond what the individual works permit. Inclusion of a covered work in an aggregate does not cause this License to apply to the other parts of the aggregate.

6. Conveying Non-Source Forms.

You may convey a covered work in object code form under the terms of sections 4 and 5, provided that you also convey the machine-readable Corresponding Source under the terms of this License, in one of these ways:

a) Convey the object code in, or embodied in, a physical product (including a physical distribution medium), accompanied by the Corresponding Source fixed on a durable physical medium customarily used for software interchange.

b) Convey the object code in, or embodied in, a physical product (including a physical distribution medium), accompanied by a written offer, valid for at least three years and valid for as long as you offer spare parts or customer support for that product model, to give anyone who possesses the object code either (1) a copy of the Corresponding Source for all the software in the product that is covered by this License, on a durable physical medium customarily used for software interchange, for a price no more than your reasonable cost of physically performing this conveying of source, or (2) access to copy the Corresponding Source from a network server at no charge.

c) Convey individual copies of the object code with a copy of the written offer to provide the Corresponding Source. This alternative is allowed only occasionally and noncommercially, and only if you received the object code with such an offer, in accord with subsection 6b.

d) Convey the object code by offering access from a designated place (gratis or for a charge), and offer equivalent access to the Corresponding Source in the same way through the same place at no further charge. You need not require recipients to copy the Corresponding Source along with the object code. If the place to copy the object code is a network server, the Corresponding Source may be on a different server (operated by you or a third party) that supports equivalent copying facilities, provided you maintain clear directions next to the object code saying where to find the Corresponding Source. Regardless of what server hosts the Corresponding Source, you remain obligated to ensure that it is available for as long as needed to satisfy these requirements.

e) Convey the object code using peer-to-peer transmission, provided you inform other peers where the object code and Corresponding Source of the work are being offered to the general public at no charge under subsection 6d.

A separable portion of the object code, whose source code is excluded from the Corresponding Source as a System Library, need not be included in conveying the object code work.

A "User Product" is either (1) a "consumer product", which means any tangible personal property which is normally used for personal, family, or household purposes, or (2) anything designed or sold for incorporation into a dwelling. In determining whether a product is a consumer product, doubtful cases shall be resolved in favor of coverage. For a particular product received by a particular user, "normally used" refers to a typical or common use of that class of product, regardless of the status of the particular user or of the way in which the particular user actually uses, or expects or is expected to use, the product. A product is a consumer product regardless of whether the product has substantial commercial, industrial or non-consumer uses, unless such uses represent the only significant mode of use of the product.

"Installation Information" for a User Product means any methods, procedures, authorization keys, or other information required to install and execute modified versions of a covered work in that User Product from a modified version of its Corresponding Source. The information must suffice to ensure that the continued functioning of the modified object code is in no case prevented or interfered with solely because modification has been made.

If you convey an object code work under this section in, or with, or specifically for use in, a User Product, and the conveying occurs as part of a transaction in which the right of possession and use of the User Product is transferred to the recipient in perpetuity or for a fixed term (regardless of how the transaction is characterized), the Corresponding Source conveyed under this section must be accompanied by the Installation Information. But this requirement does not apply if neither you nor any third party retains the ability to install modified object code on the User Product (for example, the work has been installed in ROM).

The requirement to provide Installation Information does not include a requirement to continue to provide support service, warranty, or updates for a work that has been modified or installed by the recipient, or for the User Product in which it has been modified or installed. Access to a network may be denied when the modification itself materially and adversely affects the operation of the network or violates the rules and protocols for communication across the network.

Corresponding Source conveyed, and Installation Information provided, in accord with this section must be in a format that is publicly documented (and with an implementation available to the public in source code form), and must require no special password or key for unpacking, reading or copying.

7. Additional Terms.

"Additional permissions" are terms that supplement the terms of this License by making exceptions from one or more of its conditions. Additional permissions that are applicable to the entire Program shall be treated as though they were included in this License, to the extent that they are valid under applicable law. If additional permissions apply only to part of the Program, that part may be used separately under those permissions, but the entire Program remains governed by this License without regard to the additional permissions.

When you convey a copy of a covered work, you may at your option remove any additional permissions from that copy, or from any part of it. (Additional permissions may be written to require their own removal in certain cases when you modify the work.) You may place additional permissions on material, added by you to a covered work, for which you have or can give appropriate copyright permission.

Notwithstanding any other provision of this License, for material you add to a covered work, you may (if authorized by the copyright holders of that material) supplement the terms of this License with terms:

a) Disclaiming warranty or limiting liability differently from the terms of sections 15 and 16 of this License; or

b) Requiring preservation of specified reasonable legal notices or author attributions in that material or in the Appropriate Legal Notices displayed by works containing it; or

c) Prohibiting misrepresentation of the origin of that material, or requiring that modified versions of such material be marked in reasonable ways as different from the original version; or

d) Limiting the use for publicity purposes of names of licensors or authors of the material; or

e) Declining to grant rights under trademark law for use of some trade names, trademarks, or service marks; or

f) Requiring indemnification of licensors and authors of that material by anyone who conveys the material (or modified versions of it) with contractual assumptions of liability to the recipient, for any liability that these contractual assumptions directly impose on those licensors and authors.

All other non-permissive additional terms are considered "further restrictions" within the meaning of section 10. If the Program as you received it, or any part of it, contains a notice stating that it is governed by this License along with a term that is a further restriction, you may remove that term. If a license document contains a further restriction but permits relicensing or conveying under this License, you may add to a covered work material governed by the terms of that license document, provided that the further restriction does not survive such relicensing or conveying.

If you add terms to a covered work in accord with this section, you must place, in the relevant source files, a statement of the additional terms that apply to those files, or a notice indicating where to find the applicable terms.

Additional terms, permissive or non-permissive, may be stated in the form of a separately written license, or stated as exceptions; the above requirements apply either way.

8. Termination.

You may not propagate or modify a covered work except as expressly provided under this License. Any attempt otherwise to propagate or modify it is void, and will automatically terminate your rights under this License (including any patent licenses granted under the third paragraph of section 11).

However, if you cease all violation of this License, then your license from a particular copyright holder is reinstated (a) provisionally, unless and until the copyright holder explicitly and finally terminates your license, and (b) permanently, if the copyright holder fails to notify you of the violation by some reasonable means prior to 60 days after the cessation.

Moreover, your license from a particular copyright holder is reinstated permanently if the copyright holder notifies you of the violation by some reasonable means, this is the first time you have received notice of violation of this License (for any work) from that copyright holder, and you cure the violation prior to 30 days after your receipt of the notice.

Termination of your rights under this section does not terminate the licenses of parties who have received copies or rights from you under this License. If your rights have been terminated and not permanently reinstated, you do not qualify to receive new licenses for the same material under section 10.

9. Acceptance Not Required for Having Copies.

You are not required to accept this License in order to receive or run a copy of the Program. Ancillary propagation of a covered work occurring solely as a consequence of using peer-to-peer transmission to receive a copy likewise does not require acceptance. However, nothing other than this License grants you

permission to propagate or modify any covered work. These actions infringe copyright if you do not accept this License. Therefore, by modifying or propagating a covered work, you indicate your acceptance of this License to do so.

10. Automatic Licensing of Downstream Recipients.

Each time you convey a covered work, the recipient automatically receives a license from the original licensors, to run, modify and propagate that work, subject to this License. You are not responsible for enforcing compliance by third parties with this License.

An "entity transaction" is a transaction transferring control of an organization, or substantially all assets of one, or subdividing an organization, or merging organizations. If propagation of a covered work results from an entity transaction, each party to that transaction who receives a copy of the work also receives whatever licenses to the work the party's predecessor in interest had or could give under the previous paragraph, plus a right to possession of the Corresponding Source of the work from the predecessor in interest, if the predecessor has it or can get it with reasonable efforts.

You may not impose any further restrictions on the exercise of the rights granted or affirmed under this License. For example, you may not impose a license fee, royalty, or other charge for exercise of rights granted under this License, and you may not initiate litigation (including a cross-claim or counterclaim in a lawsuit) alleging that any patent claim is infringed by making, using, selling, offering for sale, or importing the Program or any portion of it.

11. Patents.

A "contributor" is a copyright holder who authorizes use under this License of the Program or a work on which the Program is based. The work thus licensed is called the contributor's "contributor version".

A contributor's "essential patent claims" are all patent claims owned or controlled by the contributor, whether already acquired or hereafter acquired, that would be infringed by some manner, permitted by this License, of making, using, or selling its contributor version, but do not include claims that would be infringed only as a consequence of further modification of the contributor version. For purposes of this definition, "control" includes the right to grant patent sublicenses in a manner consistent with the requirements of this License.

Each contributor grants you a non-exclusive, worldwide, royalty-free patent license under the contributor's essential patent claims, to make, use, sell, offer for sale, import and otherwise run, modify and propagate the contents of its contributor version.

In the following three paragraphs, a "patent license" is any express agreement or commitment, however denominated, not to enforce a patent (such as an express permission to practice a patent or covenant not to sue for patent infringement). To "grant" such a patent license to a party means to make such an agreement or commitment not to enforce a patent against the party.

If you convey a covered work, knowingly relying on a patent license, and the Corresponding Source of the work is not available for anyone to copy, free of charge and under the terms of this License, through a publicly available network server or other readily accessible means, then you must either (1) cause the Corresponding Source to be so available, or (2) arrange to deprive yourself of the benefit of the patent license for this particular work, or (3) arrange, in a manner consistent with the requirements of this License, to extend the patent license to downstream recipients. "Knowingly relying" means you have actual knowledge that, but for the patent license, your conveying the covered work in a country, or your recipient's use of the covered work in a country, would infringe one or more identifiable patents in that country that you have reason to believe are valid.

If, pursuant to or in connection with a single transaction or arrangement, you convey, or propagate by procuring conveyance of, a covered work, and grant a patent license to some of the parties receiving the covered work authorizing them to use, propagate, modify or convey a specific copy of the covered work, then the patent license you grant is automatically extended to all recipients of the covered work and works based on it.

A patent license is "discriminatory" if it does not include within the scope of its coverage, prohibits the exercise of, or is conditioned on the non-exercise of one or more of the rights that are specifically granted under this License. You may not convey a covered work if you are a party to an arrangement with a third party that is in the business of distributing software, under which you make payment to the third party based on the extent of your activity of conveying the work, and under which the third party grants, to any of the parties who would receive the covered work from you, a discriminatory patent license (a) in connection with copies of the covered work conveyed by you (or copies made from those copies), or (b) primarily for and in connection with specific products or compilations that contain the covered work, unless you entered into that arrangement, or that patent license was granted, prior to 28 March 2007.

Nothing in this License shall be construed as excluding or limiting any implied license or other defenses to infringement that may otherwise be available to you under applicable patent law.

12. No Surrender of Others' Freedom.

If conditions are imposed on you (whether by court order, agreement or otherwise) that contradict the conditions of this License, they do not excuse you from the conditions of this License. If you cannot convey a covered work so as to satisfy simultaneously your obligations under this License and any other pertinent obligations, then as a consequence you may not convey it at all. For example, if you agree to terms that obligate you to collect a royalty for further conveying from those to whom you convey the Program, the only way you could satisfy both those terms and this License would be to refrain entirely from conveying the Program.

13. Use with the GNU Affero General Public License.

Notwithstanding any other provision of this License, you have permission to link or combine any covered work with a work licensed under version 3 of the GNU Affero General Public License into a single combined work, and to convey the resulting work. The terms of this License will continue to apply to the part which is the covered work, but the special requirements of the GNU Affero General Public License, section 13, concerning interaction through a network will apply to the combination as such.

14. Revised Versions of this License.

The Free Software Foundation may publish revised and/or new versions of the GNU General Public License from time to time. Such new versions will be similar in spirit to the present version, but may differ in detail to address new problems or concerns.

Each version is given a distinguishing version number. If the Program specifies that a certain numbered version of the GNU General Public License "or any later version" applies to it, you have the option of following the terms and conditions either of that numbered version or of any later version published by the Free Software Foundation. If the Program does not specify a version number of the GNU General Public License, you may choose any version ever published by the Free Software Foundation.

If the Program specifies that a proxy can decide which future versions of the GNU General Public License can be used, that proxy's public statement of acceptance of a version permanently authorizes you to choose that version for the Program.

Later license versions may give you additional or different permissions. However, no additional obligations are imposed on any author or copyright holder as a result of your choosing to follow a later version.

15. Disclaimer of Warranty.

THERE IS NO WARRANTY FOR THE PROGRAM, TO THE EXTENT PERMITTED BY APPLICABLE LAW. EXCEPT WHEN OTHERWISE STATED IN WRITING THE COPYRIGHT HOLDERS AND/OR OTHER PARTIES PROVIDE THE PROGRAM "AS IS" WITHOUT WARRANTY OF ANY KIND, EITHER EXPRESSED OR IMPLIED, INCLUDING, BUT NOT LIMITED TO, THE IMPLIED WARRANTIES OF MERCHANTABILITY AND FITNESS FOR A PARTICULAR PURPOSE. THE ENTIRE RISK AS TO THE QUALITY AND PERFORMANCE OF THE PROGRAM IS WITH YOU. SHOULD THE PROGRAM PROVE DEFECTIVE, YOU ASSUME THE COST OF ALL NECESSARY SERVICING, REPAIR OR CORRECTION.

16. Limitation of Liability.

IN NO EVENT UNLESS REQUIRED BY APPLICABLE LAW OR AGREED TO IN WRITING WILL ANY COPYRIGHT HOLDER, OR ANY OTHER PARTY WHO MODIFIES AND/OR CONVEYS THE PROGRAM AS PERMITTED ABOVE, BE LIABLE TO YOU FOR DAMAGES, INCLUDING ANY GENERAL, SPECIAL, INCIDENTAL OR CONSEQUENTIAL DAMAGES ARISING OUT OF THE USE OR INABILITY TO USE THE PROGRAM (INCLUDING BUT NOT LIMITED TO LOSS OF DATA OR DATA BEING RENDERED INACCURATE OR LOSSES SUSTAINED BY YOU OR THIRD PARTIES OR A FAILURE OF THE PROGRAM TO OPERATE WITH ANY OTHER PROGRAMS), EVEN IF SUCH HOLDER OR OTHER PARTY HAS BEEN ADVISED OF THE POSSIBILITY OF SUCH DAMAGES.

17. Interpretation of Sections 15 and 16.

If the disclaimer of warranty and limitation of liability provided above cannot be given local legal effect according to their terms, reviewing courts shall apply local law that most closely approximates an absolute waiver of all civil liability in connection with the Program, unless a warranty or assumption of liability accompanies a copy of the Program in return for a fee.

END OF TERMS AND CONDITIONS

How to Apply These Terms to Your New Programs

If you develop a new program, and you want it to be of the greatest possible use to the public, the best way to achieve this is to make it free software which everyone can redistribute and change under these terms.

To do so, attach the following notices to the program. It is safest to attach them to the start of each source file to most effectively state the exclusion of warranty; and each file should have at least the "copyright" line and a pointer to where the full notice is found.

```
<one line to give the program's name and a brief idea of what it does.>
Copyright (C) <year> <name of author>
```

This program is free software: you can redistribute it and/or modify it under the terms of the GNU General Public License as published by the Free Software Foundation, either version 3 of the License, or (at your option) any later version.

This program is distributed in the hope that it will be useful, but WITHOUT ANY WARRANTY; without even the implied warranty of MERCHANTABILITY or FITNESS FOR A PARTICULAR PURPOSE. See the GNU General Public License for more details.

You should have received a copy of the GNU General Public License along with this program. If not, see <http://www.gnu.org/licenses/>.

Also add information on how to contact you by electronic and paper mail.

If the program does terminal interaction, make it output a short notice like this when it starts in an interactive mode:

```
<program> Copyright (C) <year> <name of author> This program comes with
ABSOLUTELY NO WARRANTY; for details type `show w'. This is free software, and
you are welcome to redistribute it under certain conditions; type `show c'
for details.
```

The hypothetical commands `show w' and `show c' should show the appropriate parts of the General Public License. Of course, your program's commands might be different; for a GUI interface, you would use an "about box".

You should also get your employer (if you work as a programmer) or school, if any, to sign a "copyright disclaimer" for the program, if necessary. For more information on this, and how to apply and follow the GNU GPL, see <http://www.gnu.org/licenses/>.

The GNU General Public License does not permit incorporating your program into proprietary programs. If your program is a subroutines library, you may consider it more useful to permit linking proprietary applications with the library. If this is what you want to do, use the GNU Lesser General Public License instead of this License. But first, please read <http://www.gnu.org/philosophy/why-not-lgpl.html>.

jquery 1.8.2

The MIT License (MIT)

```
Copyright (c) <year> <copyright holders>
```

Permission is hereby granted, free of charge, to any person obtaining a copy of this software and associated documentation files (the "Software"), to deal in the Software without restriction, including without limitation the rights to use, copy, modify, merge, publish, distribute, sublicense, and/or sell copies of the Software, and to permit persons to whom the Software is furnished to do so, subject to the following conditions:

The above copyright notice and this permission notice shall be included in all copies or substantial portions of the Software.

THE SOFTWARE IS PROVIDED "AS IS", WITHOUT WARRANTY OF ANY KIND, EXPRESS OR IMPLIED, INCLUDING BUT NOT LIMITED TO THE WARRANTIES OF MERCHANTABILITY, FITNESS FOR A PARTICULAR PURPOSE AND NONINFRINGEMENT. IN NO EVENT SHALL THE AUTHORS OR COPYRIGHT HOLDERS BE LIABLE FOR ANY CLAIM, DAMAGES OR OTHER LIABILITY, WHETHER IN AN ACTION OF CONTRACT, TORT OR OTHERWISE, ARISING FROM, OUT OF OR IN CONNECTION WITH THE SOFTWARE OR THE USE OR OTHER DEALINGS IN THE SOFTWARE.

json-c 0.9

```
Copyright (c) 2004, 2005 Metaparadigm Pte Ltd
```

Permission is hereby granted, free of charge, to any person obtaining a copy of this software and associated documentation files (the "Software"), to deal in the Software without restriction, including without limitation the rights to use, copy, modify, merge, publish, distribute, sublicense, and/or sell copies of the Software, and to permit persons to whom the Software is furnished to do so, subject to the following conditions:

The above copyright notice and this permission notice shall be included in all copies or substantial portions of the Software.

THE SOFTWARE IS PROVIDED "AS IS", WITHOUT WARRANTY OF ANY KIND, EXPRESS OR IMPLIED, INCLUDING BUT NOT LIMITED TO THE WARRANTIES OF MERCHANTABILITY, FITNESS FOR A PARTICULAR PURPOSE AND NONINFRINGEMENT. IN NO EVENT SHALL THE AUTHORS OR COPYRIGHT HOLDERS BE LIABLE FOR ANY CLAIM, DAMAGES OR OTHER LIABILITY, WHETHER IN AN ACTION OF CONTRACT, TORT OR OTHERWISE, ARISING FROM, OUT OF OR IN CONNECTION WITH THE SOFTWARE OR THE USE OR OTHER DEALINGS IN THE SOFTWARE.

libcurl 7.40.0

COPYRIGHT AND PERMISSION NOTICE

Copyright (c) 1996 - 2015, Daniel Stenberg, <daniel@haxx.se>.

All rights reserved.

Permission to use, copy, modify, and distribute this software for any purpose with or without fee is hereby granted, provided that the above copyright notice and this permission notice appear in all copies.

THE SOFTWARE IS PROVIDED "AS IS", WITHOUT WARRANTY OF ANY KIND, EXPRESS OR IMPLIED, INCLUDING BUT NOT LIMITED TO THE WARRANTIES OF MERCHANTABILITY, FITNESS FOR A PARTICULAR PURPOSE AND NONINFRINGEMENT OF THIRD PARTY RIGHTS. IN NO EVENT SHALL THE AUTHORS OR COPYRIGHT HOLDERS BE LIABLE FOR ANY CLAIM, DAMAGES OR OTHER LIABILITY, WHETHER IN AN ACTION OF CONTRACT, TORT OR OTHERWISE, ARISING FROM, OUT OF OR IN CONNECTION WITH THE SOFTWARE OR THE USE OR OTHER DEALINGS IN THE SOFTWARE.

Except as contained in this notice, the name of a copyright holder shall not be used in advertising or otherwise to promote the sale, use or other dealings in this Software without prior written authorization of the copyright holder.

libwebui

GNU LESSER GENERAL PUBLIC LICENSE

Version 2.1, February 1999

Copyright (C) 1991, 1999 Free Software Foundation, Inc. 51 Franklin St, Fifth Floor, Boston, MA 02110-1301 USA Everyone is permitted to copy and distribute verbatim copies of this license document, but changing it is not allowed.

[This is the first released version of the Lesser GPL. It also counts as the successor of the GNU Library Public License, version 2, hence the version number 2.1.]

Preamble

The licenses for most software are designed to take away your freedom to share and change it. By contrast, the GNU General Public Licenses are intended to guarantee your freedom to share and change free software--to make sure the software is free for all its users.

This license, the Lesser General Public License, applies to some specially designated software packages--typically libraries--of the Free Software Foundation and other authors who decide to use it. You can use it too, but we suggest you first think carefully about whether this license or the ordinary General Public License is the better strategy to use in any particular case, based on the explanations below.

When we speak of free software, we are referring to freedom of use, not price. Our General Public Licenses are designed to make sure that you have the freedom to distribute copies of free software (and charge for this service if you wish); that you receive source code or can get it if you want it; that you can change the software and use pieces of it in new free programs; and that you are informed that you can do these things.

To protect your rights, we need to make restrictions that forbid distributors to deny you these rights or to ask you to surrender these rights. These restrictions translate to certain responsibilities for you if you distribute copies of the library or if you modify it.

For example, if you distribute copies of the library, whether gratis or for a fee, you must give the recipients all the rights that we gave you. You must make sure that they, too, receive or can get the source code. If you link other code

with the library, you must provide complete object files to the recipients, so that they can relink them with the library after making changes to the library and recompiling it. And you must show them these terms so they know their rights.

We protect your rights with a two-step method: (1) we copyright the library, and (2) we offer you this license, which gives you legal permission to copy, distribute and/or modify the library.

To protect each distributor, we want to make it very clear that there is no warranty for the free library. Also, if the library is modified by someone else and passed on, the recipients should know that what they have is not the original version, so that the original author's reputation will not be affected by problems that might be introduced by others.

Finally, software patents pose a constant threat to the existence of any free program. We wish to make sure that a company cannot effectively restrict the users of a free program by obtaining a restrictive license from a patent holder. Therefore, we insist that any patent license obtained for a version of the library must be consistent with the full freedom of use specified in this license.

Most GNU software, including some libraries, is covered by the ordinary GNU General Public License. This license, the GNU Lesser General Public License, applies to certain designated libraries, and is quite different from the ordinary General Public License. We use this license for certain libraries in order to permit linking those libraries into non-free programs.

When a program is linked with a library, whether statically or using a shared library, the combination of the two is legally speaking a combined work, a derivative of the original library. The ordinary General Public License therefore permits such linking only if the entire combination fits its criteria of freedom. The Lesser General Public License permits more lax criteria for linking other code with the library.

We call this license the "Lesser" General Public License because it does Less to protect the user's freedom than the ordinary General Public License. It also provides other free software developers Less of an advantage over competing non-free programs. These disadvantages are the reason we use the ordinary General Public License for many libraries. However, the Lesser license provides advantages in certain special circumstances.

For example, on rare occasions, there may be a special need to encourage the widest possible use of a certain library, so that it becomes a de-facto standard. To achieve this, non-free programs must be allowed to use the library. A more frequent case is that a free library does the same job as widely used non-free libraries. In this case, there is little to gain by limiting the free library to free software only, so we use the Lesser General Public License.

In other cases, permission to use a particular library in non-free programs enables a greater number of people to use a large body of free software. For example, permission to use the GNU C Library in non-free programs enables many more people to use the whole GNU operating system, as well as its variant, the GNU/Linux operating system.

Although the Lesser General Public License is Less protective of the users' freedom, it does ensure that the user of a program that is linked with the Library has the freedom and the wherewithal to run that program using a modified version of the Library.

The precise terms and conditions for copying, distribution and modification follow. Pay close attention to the difference between a "work based on the library" and a "work that uses the library". The former contains code derived from the library, whereas the latter must be combined with the library in order to run.

GNU LESSER GENERAL PUBLIC LICENSE TERMS AND CONDITIONS FOR COPYING,
DISTRIBUTION AND MODIFICATION

0. This License Agreement applies to any software library or other program which contains a notice placed by the copyright holder or other authorized party saying it may be distributed under the terms of this Lesser General Public License (also called "this License"). Each licensee is addressed as "you".

A "library" means a collection of software functions and/or data prepared so as to be conveniently linked with application programs (which use some of those functions and data) to form executables.

The "Library", below, refers to any such software library or work which has been distributed under these terms. A "work based on the Library" means either the Library or any derivative work under copyright law: that is to say, a work containing the Library or a portion of it, either verbatim or with modifications and/or translated straightforwardly into another language. (Hereinafter, translation is included without limitation in the term "modification".)

"Source code" for a work means the preferred form of the work for making modifications to it. For a library, complete source code means all the source code for all modules it contains, plus any associated interface definition files, plus the scripts used to control compilation and installation of the library.

Activities other than copying, distribution and modification are not covered by this License; they are outside its scope. The act of running a program using the Library is not restricted, and output from such a program is covered only if its contents constitute a work based on the Library (independent of the use of the Library in a tool for writing it). Whether that is true depends on what the Library does and what the program that uses the Library does.

1. You may copy and distribute verbatim copies of the Library's complete source code as you receive it, in any medium, provided that you conspicuously and appropriately publish on each copy an appropriate copyright notice and disclaimer of warranty; keep intact all the notices that refer to this License and to the absence of any warranty; and distribute a copy of this License along with the Library.

You may charge a fee for the physical act of transferring a copy, and you may at your option offer warranty protection in exchange for a fee.

2. You may modify your copy or copies of the Library or any portion of it, thus forming a work based on the Library, and copy and distribute such modifications or work under the terms of Section 1 above, provided that you also meet all of these conditions:

- a) The modified work must itself be a software library.
- b) You must cause the files modified to carry prominent notices stating that you changed the files and the date of any change.
- c) You must cause the whole of the work to be licensed at no charge to all third parties under the terms of this License.
- d) If a facility in the modified Library refers to a function or a table of data to be supplied by an application program that uses the facility, other than as an argument passed when the facility is invoked, then you must make a good faith effort to ensure that, in the event an application does not supply such function or table, the facility still operates, and performs whatever part of its purpose remains meaningful.

(For example, a function in a library to compute square roots has a purpose that is entirely well-defined independent of the application. Therefore, Subsection 2d requires that any application-supplied function or table used by this function must be optional: if the application does not supply it, the square root function must still compute square roots.)

These requirements apply to the modified work as a whole. If identifiable sections of that work are not derived from the Library, and can be reasonably considered independent and separate works in themselves, then this License, and its terms, do not apply to those sections when you distribute them as separate works. But when you distribute the same sections as part of a whole which is a work based on

the Library, the distribution of the whole must be on the terms of this License, whose permissions for other licensees extend to the entire whole, and thus to each and every part regardless of who wrote it.

Thus, it is not the intent of this section to claim rights or contest your rights to work written entirely by you; rather, the intent is to exercise the right to control the distribution of derivative or collective works based on the Library.

In addition, mere aggregation of another work not based on the Library with the Library (or with a work based on the Library) on a volume of a storage or distribution medium does not bring the other work under the scope of this License.

3. You may opt to apply the terms of the ordinary GNU General Public License instead of this License to a given copy of the Library. To do this, you must alter all the notices that refer to this License, so that they refer to the ordinary GNU General Public License, version 2, instead of to this License. (If a newer version than version 2 of the ordinary GNU General Public License has appeared, then you can specify that version instead if you wish.) Do not make any other change in these notices.

Once this change is made in a given copy, it is irreversible for that copy, so the ordinary GNU General Public License applies to all subsequent copies and derivative works made from that copy.

This option is useful when you wish to copy part of the code of the Library into a program that is not a library.

4. You may copy and distribute the Library (or a portion or derivative of it, under Section 2) in object code or executable form under the terms of Sections 1 and 2 above provided that you accompany it with the complete corresponding machine-readable source code, which must be distributed under the terms of Sections 1 and 2 above on a medium customarily used for software interchange.

If distribution of object code is made by offering access to copy from a designated place, then offering equivalent access to copy the source code from the same place satisfies the requirement to distribute the source code, even though third parties are not compelled to copy the source along with the object code.

5. A program that contains no derivative of any portion of the Library, but is designed to work with the Library by being compiled or linked with it, is called a "work that uses the Library". Such a work, in isolation, is not a derivative work of the Library, and therefore falls outside the scope of this License.

However, linking a "work that uses the Library" with the Library creates an executable that is a derivative of the Library (because it contains portions of the Library), rather than a "work that uses the library". The executable is therefore covered by this License. Section 6 states terms for distribution of such executables.

When a "work that uses the Library" uses material from a header file that is part of the Library, the object code for the work may be a derivative work of the Library even though the source code is not. Whether this is true is especially significant if the work can be linked without the Library, or if the work is itself a library. The threshold for this to be true is not precisely defined by law.

If such an object file uses only numerical parameters, data structure layouts and accessors, and small macros and small inline functions (ten lines or less in length), then the use of the object file is unrestricted, regardless of whether it is legally a derivative work. (Executables containing this object code plus portions of the Library will still fall under Section 6.)

Otherwise, if the work is a derivative of the Library, you may distribute the object code for the work under the terms of Section 6. Any executables containing that work also fall under Section 6, whether or not they are linked directly with the Library itself.

6. As an exception to the Sections above, you may also combine or link a "work that uses the Library" with the Library to produce a work containing portions of the Library, and distribute that work under terms of your choice, provided that the terms permit modification of the work for the customer's own use and reverse engineering for debugging such modifications.

You must give prominent notice with each copy of the work that the Library is used in it and that the Library and its use are covered by this License. You must supply a copy of this License. If the work during execution displays copyright notices, you must include the copyright notice for the Library among them, as well as a reference directing the user to the copy of this License. Also, you must do one of these things:

a) Accompany the work with the complete corresponding machine-readable source code for the Library including whatever changes were used in the work (which must be distributed under Sections 1 and 2 above); and, if the work is an executable linked with the Library, with the complete machine-readable "work that uses the Library", as object code and/or source code, so that the user can modify the Library and then relink to produce a modified executable containing the modified Library. (It is understood that the user who changes the contents of definitions files in the Library will not necessarily be able to recompile the application to use the modified definitions.)

b) Use a suitable shared library mechanism for linking with the Library. A suitable mechanism is one that (1) uses at run time a copy of the library already present on the user's computer system, rather than copying library functions into the executable, and (2) will operate properly with a modified version of the library, if the user installs one, as long as the modified version is interface-compatible with the version that the work was made with.

c) Accompany the work with a written offer, valid for at least three years, to give the same user the materials specified in Subsection 6a, above, for a charge no more than the cost of performing this distribution.

d) If distribution of the work is made by offering access to copy from a designated place, offer equivalent access to copy the above specified materials from the same place.

e) Verify that the user has already received a copy of these materials or that you have already sent this user a copy.

For an executable, the required form of the "work that uses the Library" must include any data and utility programs needed for reproducing the executable from it. However, as a special exception, the materials to be distributed need not include anything that is normally distributed (in either source or binary form) with the major components (compiler, kernel, and so on) of the operating system on which the executable runs, unless that component itself accompanies the executable.

It may happen that this requirement contradicts the license restrictions of other proprietary libraries that do not normally accompany the operating system. Such a contradiction means you cannot use both them and the Library together in an executable that you distribute.

7. You may place library facilities that are a work based on the Library side-by-side in a single library together with other library facilities not covered by this License, and distribute such a combined library, provided that the separate distribution of the work based on the Library and of the other library facilities is otherwise permitted, and provided that you do these two things:

a) Accompany the combined library with a copy of the same work based on the Library, uncombined with any other library facilities. This must be distributed under the terms of the Sections above.

b) Give prominent notice with the combined library of the fact that part of it is a work based on the Library, and explaining where to find the accompanying uncombined form of the same work.

8. You may not copy, modify, sublicense, link with, or distribute the Library except as expressly provided under this License. Any attempt otherwise to copy, modify, sublicense, link with, or distribute the Library is void, and will automatically terminate your rights under this License. However, parties who have received copies, or rights, from you under this License will not have their licenses terminated so long as such parties remain in full compliance.

9. You are not required to accept this License, since you have not signed it. However, nothing else grants you permission to modify or distribute the Library or its derivative works. These actions are prohibited by law if you do not accept this License. Therefore, by modifying or distributing the Library (or any work based on the Library), you indicate your acceptance of this License to do so, and all its terms and conditions for copying, distributing or modifying the Library or works based on it.

10. Each time you redistribute the Library (or any work based on the Library), the recipient automatically receives a license from the original licensor to copy, distribute, link with or modify the Library subject to these terms and conditions. You may not impose any further restrictions on the recipients' exercise of the rights granted herein. You are not responsible for enforcing compliance by third parties with this License.

11. If, as a consequence of a court judgment or allegation of patent infringement or for any other reason (not limited to patent issues), conditions are imposed on you (whether by court order, agreement or otherwise) that contradict the conditions of this License, they do not excuse you from the conditions of this License. If you cannot distribute so as to satisfy simultaneously your obligations under this License and any other pertinent obligations, then as a consequence you may not distribute the Library at all. For example, if a patent license would not permit royalty-free redistribution of the Library by all those who receive copies directly or indirectly through you, then the only way you could satisfy both it and this License would be to refrain entirely from distribution of the Library.

If any portion of this section is held invalid or unenforceable under any particular circumstance, the balance of the section is intended to apply, and the section as a whole is intended to apply in other circumstances.

It is not the purpose of this section to induce you to infringe any patents or other property right claims or to contest validity of any such claims; this section has the sole purpose of protecting the integrity of the free software distribution system which is implemented by public license practices. Many people have made generous contributions to the wide range of software distributed through that system in reliance on consistent application of that system; it is up to the author/donor to decide if he or she is willing to distribute software through any other system and a licensee cannot impose that choice.

This section is intended to make thoroughly clear what is believed to be a consequence of the rest of this License.

12. If the distribution and/or use of the Library is restricted in certain countries either by patents or by copyrighted interfaces, the original copyright holder who places the Library under this License may add an explicit geographical distribution limitation excluding those countries, so that distribution is permitted only in or among countries not thus excluded. In such case, this License incorporates the limitation as if written in the body of this License.

13. The Free Software Foundation may publish revised and/or new versions of the Lesser General Public License from time to time. Such new versions will be similar in spirit to the present version, but may differ in detail to address new problems or concerns.

Each version is given a distinguishing version number. If the Library specifies a version number of this License which applies to it and "any later version", you have the option of following the terms and conditions either of that version or

of any later version published by the Free Software Foundation. If the Library does not specify a license version number, you may choose any version ever published by the Free Software Foundation.

14. If you wish to incorporate parts of the Library into other free programs whose distribution conditions are incompatible with these, write to the author to ask for permission. For software which is copyrighted by the Free Software Foundation, write to the Free Software Foundation; we sometimes make exceptions for this. Our decision will be guided by the two goals of preserving the free status of all derivatives of our free software and of promoting the sharing and reuse of software generally.

NO WARRANTY

15. BECAUSE THE LIBRARY IS LICENSED FREE OF CHARGE, THERE IS NO WARRANTY FOR THE LIBRARY, TO THE EXTENT PERMITTED BY APPLICABLE LAW. EXCEPT WHEN OTHERWISE STATED IN WRITING THE COPYRIGHT HOLDERS AND/OR OTHER PARTIES PROVIDE THE LIBRARY "AS IS" WITHOUT WARRANTY OF ANY KIND, EITHER EXPRESSED OR IMPLIED, INCLUDING, BUT NOT LIMITED TO, THE IMPLIED WARRANTIES OF MERCHANTABILITY AND FITNESS FOR A PARTICULAR PURPOSE. THE ENTIRE RISK AS TO THE QUALITY AND PERFORMANCE OF THE LIBRARY IS WITH YOU. SHOULD THE LIBRARY PROVE DEFECTIVE, YOU ASSUME THE COST OF ALL NECESSARY SERVICING, REPAIR OR CORRECTION.

16. IN NO EVENT UNLESS REQUIRED BY APPLICABLE LAW OR AGREED TO IN WRITING WILL ANY COPYRIGHT HOLDER, OR ANY OTHER PARTY WHO MAY MODIFY AND/OR REDISTRIBUTE THE LIBRARY AS PERMITTED ABOVE, BE LIABLE TO YOU FOR DAMAGES, INCLUDING ANY GENERAL, SPECIAL, INCIDENTAL OR CONSEQUENTIAL DAMAGES ARISING OUT OF THE USE OR INABILITY TO USE THE LIBRARY (INCLUDING BUT NOT LIMITED TO LOSS OF DATA OR DATA BEING RENDERED INACCURATE OR LOSSES SUSTAINED BY YOU OR THIRD PARTIES OR A FAILURE OF THE LIBRARY TO OPERATE WITH ANY OTHER SOFTWARE), EVEN IF SUCH HOLDER OR OTHER PARTY HAS BEEN ADVISED OF THE POSSIBILITY OF SUCH DAMAGES.

END OF TERMS AND CONDITIONS

How to Apply These Terms to Your New Libraries

If you develop a new library, and you want it to be of the greatest possible use to the public, we recommend making it free software that everyone can redistribute and change. You can do so by permitting redistribution under these terms (or, alternatively, under the terms of the ordinary General Public License).

To apply these terms, attach the following notices to the library. It is safest to attach them to the start of each source file to most effectively convey the exclusion of warranty; and each file should have at least the "copyright" line and a pointer to where the full notice is found.

```
<one line to give the library's name and a brief idea of what it does.>
Copyright (C) <year> <name of author>
```

This library is free software; you can redistribute it and/or modify it under the terms of the GNU Lesser General Public License as published by the Free Software Foundation; either version 2.1 of the License, or (at your option) any later version.

This library is distributed in the hope that it will be useful, but WITHOUT ANY WARRANTY; without even the implied warranty of MERCHANTABILITY or FITNESS FOR A PARTICULAR PURPOSE. See the GNU Lesser General Public License for more details.

You should have received a copy of the GNU Lesser General Public License along with this library; if not, write to the Free Software Foundation, Inc., 51 Franklin St, Fifth Floor, Boston, MA 02110-1301 USA

Also add information on how to contact you by electronic and paper mail.

You should also get your employer (if you work as a programmer) or your school, if any, to sign a "copyright disclaimer" for the library, if necessary. Here is a sample; alter the names:

```
Yoyodyne, Inc., hereby disclaims all copyright interest in the library `Frob'
(a library for tweaking knobs) written by James Random Hacker.
```

```
<signature of Ty Coon>, 1 April 1990 Ty Coon, President of Vice
```

That's all there is to it!

libevent 2.0.14

Libevent is available for use under the following license, commonly known as the 3-clause (or "modified") BSD license:

```
===== Copyright (c) 2000-2007 Niels Provos
<provos@citi.umich.edu> Copyright (c) 2007-2010 Niels Provos and Nick Mathewson
```

```
Redistribution and use in source and binary forms, with or without modification,
are permitted provided that the following conditions are met: 1. Redistributions
of source code must retain the above copyright notice, this list of conditions
and the following disclaimer. 2. Redistributions in binary form must reproduce
the above copyright notice, this list of conditions and the following disclaimer
in the documentation and/or other materials provided with the distribution. 3.
The name of the author may not be used to endorse or promote products derived
from this software without specific prior written permission.
```

```
THIS SOFTWARE IS PROVIDED BY THE AUTHOR ``AS IS'' AND ANY EXPRESS OR IMPLIED
WARRANTIES, INCLUDING, BUT NOT LIMITED TO, THE IMPLIED WARRANTIES OF
MERCHANTABILITY AND FITNESS FOR A PARTICULAR PURPOSE ARE DISCLAIMED. IN NO EVENT
SHALL THE AUTHOR BE LIABLE FOR ANY DIRECT, INDIRECT, INCIDENTAL, SPECIAL,
EXEMPLARY, OR CONSEQUENTIAL DAMAGES (INCLUDING, BUT NOT LIMITED TO, PROCUREMENT
OF SUBSTITUTE GOODS OR SERVICES; LOSS OF USE, DATA, OR PROFITS; OR BUSINESS
INTERRUPTION) HOWEVER CAUSED AND ON ANY THEORY OF LIABILITY, WHETHER IN CONTRACT,
STRICT LIABILITY, OR TORT (INCLUDING NEGLIGENCE OR OTHERWISE) ARISING IN ANY WAY
OUT OF THE USE OF THIS SOFTWARE, EVEN IF ADVISED OF THE POSSIBILITY OF SUCH DAMAGE.
=====
```

Portions of Libevent are based on works by others, also made available by them under the three-clause BSD license above. The copyright notices are available in the corresponding source files; the license is as above. Here's a list:

```
log.c: Copyright (c) 2000 Dug Song <dugsong@monkey.org> Copyright (c) 1993
The Regents of the University of California.
```

```
strlcpy.c: Copyright (c) 1998 Todd C. Miller <Todd.Miller@courtesan.com>
```

```
win32select.c: Copyright (c) 2003 Michael A. Davis <mike@datanerds.net>
```

```
evport.c: Copyright (c) 2007 Sun Microsystems
```

```
ht-internal.h: Copyright (c) 2002 Christopher Clark
```

```
minheap-internal.h: Copyright (c) 2006 Maxim Yegorushkin
<maxim.yegorushkin@gmail.com>
```

```
=====
```

The arc4module is available under the following, sometimes called the "OpenBSD" license:

Copyright (c) 1996, David Mazieres <dm@uun.org> Copyright (c) 2008, Damien Miller <djm@openbsd.org>

Permission to use, copy, modify, and distribute this software for any purpose with or without fee is hereby granted, provided that the above copyright notice and this permission notice appear in all copies.

THE SOFTWARE IS PROVIDED "AS IS" AND THE AUTHOR DISCLAIMS ALL WARRANTIES WITH REGARD TO THIS SOFTWARE INCLUDING ALL IMPLIED WARRANTIES OF MERCHANTABILITY AND FITNESS. IN NO EVENT SHALL THE AUTHOR BE LIABLE FOR ANY SPECIAL, DIRECT, INDIRECT, OR CONSEQUENTIAL DAMAGES OR ANY DAMAGES WHATSOEVER RESULTING FROM LOSS OF USE, DATA OR PROFITS, WHETHER IN AN ACTION OF CONTRACT, NEGLIGENCE OR OTHER TORTIOUS ACTION, ARISING OUT OF OR IN CONNECTION WITH THE USE OR PERFORMANCE OF THIS SOFTWARE.

libconv 1.14

GNU GENERAL PUBLIC LICENSE Version 3, 29 June 2007

Copyright (C) 2007 Free Software Foundation, Inc. <<http://fsf.org/>> Everyone is permitted to copy and distribute verbatim copies of this license document, but changing it is not allowed.

Preamble

The GNU General Public License is a free, copyleft license for software and other kinds of works.

The licenses for most software and other practical works are designed to take away your freedom to share and change the works. By contrast, the GNU General Public License is intended to guarantee your freedom to share and change all versions of a program--to make sure it remains free software for all its users. We, the Free Software Foundation, use the GNU General Public License for most of our software; it applies also to any other work released this way by its authors. You can apply it to your programs, too.

When we speak of free software, we are referring to freedom, not price. Our General Public Licenses are designed to make sure that you have the freedom to distribute copies of free software (and charge for them if you wish), that you receive source code or can get it if you want it, that you can change the software or use pieces of it in new free programs, and that you know you can do these things.

To protect your rights, we need to prevent others from denying you these rights or asking you to surrender the rights. Therefore, you have certain responsibilities if you distribute copies of the software, or if you modify it: responsibilities to respect the freedom of others.

For example, if you distribute copies of such a program, whether gratis or for a fee, you must pass on to the recipients the same freedoms that you received. You must make sure that they, too, receive or can get the source code. And you must show them these terms so they know their rights.

Developers that use the GNU GPL protect your rights with two steps: (1) assert copyright on the software, and (2) offer you this License giving you legal permission to copy, distribute and/or modify it.

For the developers' and authors' protection, the GPL clearly explains that there is no warranty for this free software. For both users' and authors' sake, the GPL requires that modified versions be marked as changed, so that their problems will not be attributed erroneously to authors of previous versions.

Some devices are designed to deny users access to install or run modified versions of the software inside them, although the manufacturer can do so. This is fundamentally incompatible with the aim of protecting users' freedom to change the software. The systematic pattern of such abuse occurs in the area of products for individuals to use, which is precisely where it is most unacceptable. Therefore, we have designed this version of the GPL to prohibit the practice for those products. If such problems arise substantially in other domains, we stand ready to extend this provision to those domains in future versions of the GPL, as needed to protect the freedom of users.

Finally, every program is threatened constantly by software patents. States should not allow patents to restrict development and use of software on general-purpose computers, but in those that do, we wish to avoid the special danger that patents applied to a free program could make it effectively proprietary. To prevent this, the GPL assures that patents cannot be used to render the program non-free.

The precise terms and conditions for copying, distribution and modification follow.

TERMS AND CONDITIONS

0. Definitions.

"This License" refers to version 3 of the GNU General Public License.

"Copyright" also means copyright-like laws that apply to other kinds of works, such as semiconductor masks.

"The Program" refers to any copyrightable work licensed under this License. Each licensee is addressed as "you". "Licensees" and "recipients" may be individuals or organizations.

To "modify" a work means to copy from or adapt all or part of the work in a fashion requiring copyright permission, other than the making of an exact copy. The resulting work is called a "modified version" of the earlier work or a work "based on" the earlier work.

A "covered work" means either the unmodified Program or a work based on the Program.

To "propagate" a work means to do anything with it that, without permission, would make you directly or secondarily liable for infringement under applicable copyright law, except executing it on a computer or modifying a private copy. Propagation includes copying, distribution (with or without modification), making available to the public, and in some countries other activities as well.

To "convey" a work means any kind of propagation that enables other parties to make or receive copies. Mere interaction with a user through a computer network, with no transfer of a copy, is not conveying.

An interactive user interface displays "Appropriate Legal Notices" to the extent that it includes a convenient and prominently visible feature that (1) displays an appropriate copyright notice, and (2) tells the user that there is no warranty for the work (except to the extent that warranties are provided), that licensees may convey the work under this License, and how to view a copy of this License. If the interface presents a list of user commands or options, such as a menu, a prominent item in the list meets this criterion.

1. Source Code.

The "source code" for a work means the preferred form of the work for making modifications to it. "Object code" means any non-source form of a work.

A "Standard Interface" means an interface that either is an official standard defined by a recognized standards body, or, in the case of interfaces specified for a particular programming language, one that is widely used among developers working in that language.

The "System Libraries" of an executable work include anything, other than the work as a whole, that (a) is included in the normal form of packaging a Major Component, but which is not part of that Major Component, and (b) serves only to enable use of the work with that Major Component, or to implement a Standard Interface for which an implementation is available to the public in source code form. A "Major Component", in this context, means a major essential component (kernel, window system, and so on) of the specific operating system (if any) on which the executable work runs, or a compiler used to produce the work, or an object code interpreter used to run it.

The "Corresponding Source" for a work in object code form means all the source code needed to generate, install, and (for an executable work) run the object code and to modify the work, including scripts to control those activities. However, it does not include the work's System Libraries, or general-purpose tools or generally available free programs which are used unmodified in performing those activities but which are not part of the work. For example, Corresponding Source includes interface definition files associated with source files for the work, and the source code for shared libraries and dynamically linked subprograms that the work is specifically designed to require, such as by intimate data communication or control flow between those subprograms and other parts of the work.

The Corresponding Source need not include anything that users can regenerate automatically from other parts of the Corresponding Source.

The Corresponding Source for a work in source code form is that same work.

2. Basic Permissions.

All rights granted under this License are granted for the term of copyright on the Program, and are irrevocable provided the stated conditions are met. This License explicitly affirms your unlimited permission to run the unmodified Program. The output from running a covered work is covered by this License only if the output, given its content, constitutes a covered work. This License acknowledges your rights of fair use or other equivalent, as provided by copyright law.

You may make, run and propagate covered works that you do not convey, without conditions so long as your license otherwise remains in force. You may convey covered works to others for the sole purpose of having them make modifications exclusively for you, or provide you with facilities for running those works, provided that you comply with the terms of this License in conveying all material for which you do not control copyright. Those thus making or running the covered works for you must do so exclusively on your behalf, under your direction and control, on terms that prohibit them from making any copies of your copyrighted material outside their relationship with you.

Conveying under any other circumstances is permitted solely under the conditions stated below. Sublicensing is not allowed; section 10 makes it unnecessary.

3. Protecting Users' Legal Rights From Anti-Circumvention Law.

No covered work shall be deemed part of an effective technological measure under any applicable law fulfilling obligations under article 11 of the WIPO copyright treaty adopted on 20 December 1996, or similar laws prohibiting or restricting circumvention of such measures.

When you convey a covered work, you waive any legal power to forbid circumvention of technological measures to the extent such circumvention is effected by exercising rights under this License with respect to the covered work, and you

disclaim any intention to limit operation or modification of the work as a means of enforcing, against the work's users, your or third parties' legal rights to forbid circumvention of technological measures.

4. Conveying Verbatim Copies.

You may convey verbatim copies of the Program's source code as you receive it, in any medium, provided that you conspicuously and appropriately publish on each copy an appropriate copyright notice; keep intact all notices stating that this License and any non-permissive terms added in accord with section 7 apply to the code; keep intact all notices of the absence of any warranty; and give all recipients a copy of this License along with the Program.

You may charge any price or no price for each copy that you convey, and you may offer support or warranty protection for a fee.

5. Conveying Modified Source Versions.

You may convey a work based on the Program, or the modifications to produce it from the Program, in the form of source code under the terms of section 4, provided that you also meet all of these conditions:

a) The work must carry prominent notices stating that you modified it, and giving a relevant date.

b) The work must carry prominent notices stating that it is released under this License and any conditions added under section 7. This requirement modifies the requirement in section 4 to "keep intact all notices".

c) You must license the entire work, as a whole, under this License to anyone who comes into possession of a copy. This License will therefore apply, along with any applicable section 7 additional terms, to the whole of the work, and all its parts, regardless of how they are packaged. This License gives no permission to license the work in any other way, but it does not invalidate such permission if you have separately received it.

d) If the work has interactive user interfaces, each must display Appropriate Legal Notices; however, if the Program has interactive interfaces that do not display Appropriate Legal Notices, your work need not make them do so.

A compilation of a covered work with other separate and independent works, which are not by their nature extensions of the covered work, and which are not combined with it such as to form a larger program, in or on a volume of a storage or distribution medium, is called an "aggregate" if the compilation and its resulting copyright are not used to limit the access or legal rights of the compilation's users beyond what the individual works permit. Inclusion of a covered work in an aggregate does not cause this License to apply to the other parts of the aggregate.

6. Conveying Non-Source Forms.

You may convey a covered work in object code form under the terms of sections 4 and 5, provided that you also convey the machine-readable Corresponding Source under the terms of this License, in one of these ways:

a) Convey the object code in, or embodied in, a physical product (including a physical distribution medium), accompanied by the Corresponding Source fixed on a durable physical medium customarily used for software interchange.

b) Convey the object code in, or embodied in, a physical product (including a physical distribution medium), accompanied by a written offer, valid for at least three years and valid for as long as you offer spare parts or customer support for that product model, to give anyone who possesses the object code either (1) a copy of the Corresponding Source for all the software in the product that is covered by this License, on a durable physical medium

customarily used for software interchange, for a price no more than your reasonable cost of physically performing this conveying of source, or (2) access to copy the Corresponding Source from a network server at no charge.

c) Convey individual copies of the object code with a copy of the written offer to provide the Corresponding Source. This alternative is allowed only occasionally and noncommercially, and only if you received the object code with such an offer, in accord with subsection 6b.

d) Convey the object code by offering access from a designated place (gratis or for a charge), and offer equivalent access to the Corresponding Source in the same way through the same place at no further charge. You need not require recipients to copy the Corresponding Source along with the object code. If the place to copy the object code is a network server, the Corresponding Source may be on a different server (operated by you or a third party) that supports equivalent copying facilities, provided you maintain clear directions next to the object code saying where to find the Corresponding Source. Regardless of what server hosts the Corresponding Source, you remain obligated to ensure that it is available for as long as needed to satisfy these requirements.

e) Convey the object code using peer-to-peer transmission, provided you inform other peers where the object code and Corresponding Source of the work are being offered to the general public at no charge under subsection 6d.

A separable portion of the object code, whose source code is excluded from the Corresponding Source as a System Library, need not be included in conveying the object code work.

A "User Product" is either (1) a "consumer product", which means any tangible personal property which is normally used for personal, family, or household purposes, or (2) anything designed or sold for incorporation into a dwelling. In determining whether a product is a consumer product, doubtful cases shall be resolved in favor of coverage. For a particular product received by a particular user, "normally used" refers to a typical or common use of that class of product, regardless of the status of the particular user or of the way in which the particular user actually uses, or expects or is expected to use, the product. A product is a consumer product regardless of whether the product has substantial commercial, industrial or non-consumer uses, unless such uses represent the only significant mode of use of the product.

"Installation Information" for a User Product means any methods, procedures, authorization keys, or other information required to install and execute modified versions of a covered work in that User Product from a modified version of its Corresponding Source. The information must suffice to ensure that the continued functioning of the modified object code is in no case prevented or interfered with solely because modification has been made.

If you convey an object code work under this section in, or with, or specifically for use in, a User Product, and the conveying occurs as part of a transaction in which the right of possession and use of the User Product is transferred to the recipient in perpetuity or for a fixed term (regardless of how the transaction is characterized), the Corresponding Source conveyed under this section must be accompanied by the Installation Information. But this requirement does not apply if neither you nor any third party retains the ability to install modified object code on the User Product (for example, the work has been installed in ROM).

The requirement to provide Installation Information does not include a requirement to continue to provide support service, warranty, or updates for a work that has been modified or installed by the recipient, or for the User Product in which it has been modified or installed. Access to a network may be denied when the modification itself materially and adversely affects the operation of the network or violates the rules and protocols for communication across the network.

Corresponding Source conveyed, and Installation Information provided, in accord with this section must be in a format that is publicly documented (and with an implementation available to the public in source code form), and must require no special password or key for unpacking, reading or copying.

7. Additional Terms.

"Additional permissions" are terms that supplement the terms of this License by making exceptions from one or more of its conditions. Additional permissions that are applicable to the entire Program shall be treated as though they were included in this License, to the extent that they are valid under applicable law. If additional permissions apply only to part of the Program, that part may be used separately under those permissions, but the entire Program remains governed by this License without regard to the additional permissions.

When you convey a copy of a covered work, you may at your option remove any additional permissions from that copy, or from any part of it. (Additional permissions may be written to require their own removal in certain cases when you modify the work.) You may place additional permissions on material, added by you to a covered work, for which you have or can give appropriate copyright permission.

Notwithstanding any other provision of this License, for material you add to a covered work, you may (if authorized by the copyright holders of that material) supplement the terms of this License with terms:

a) Disclaiming warranty or limiting liability differently from the terms of sections 15 and 16 of this License; or

b) Requiring preservation of specified reasonable legal notices or author attributions in that material or in the Appropriate Legal Notices displayed by works containing it; or

c) Prohibiting misrepresentation of the origin of that material, or requiring that modified versions of such material be marked in reasonable ways as different from the original version; or

d) Limiting the use for publicity purposes of names of licensors or authors of the material; or

e) Declining to grant rights under trademark law for use of some trade names, trademarks, or service marks; or

f) Requiring indemnification of licensors and authors of that material by anyone who conveys the material (or modified versions of it) with contractual assumptions of liability to the recipient, for any liability that these contractual assumptions directly impose on those licensors and authors.

All other non-permissive additional terms are considered "further restrictions" within the meaning of section 10. If the Program as you received it, or any part of it, contains a notice stating that it is governed by this License along with a term that is a further restriction, you may remove that term. If a license document contains a further restriction but permits relicensing or conveying under this License, you may add to a covered work material governed by the terms of that license document, provided that the further restriction does not survive such relicensing or conveying.

If you add terms to a covered work in accord with this section, you must place, in the relevant source files, a statement of the additional terms that apply to those files, or a notice indicating where to find the applicable terms.

Additional terms, permissive or non-permissive, may be stated in the form of a separately written license, or stated as exceptions; the above requirements apply either way.

8. Termination.

You may not propagate or modify a covered work except as expressly provided under this License. Any attempt otherwise to propagate or modify it is void, and will automatically terminate your rights under this License (including any patent licenses granted under the third paragraph of section 11).

However, if you cease all violation of this License, then your license from a particular copyright holder is reinstated (a) provisionally, unless and until the copyright holder explicitly and finally terminates your license, and (b) permanently, if the copyright holder fails to notify you of the violation by some reasonable means prior to 60 days after the cessation.

Moreover, your license from a particular copyright holder is reinstated permanently if the copyright holder notifies you of the violation by some reasonable means, this is the first time you have received notice of violation of this License (for any work) from that copyright holder, and you cure the violation prior to 30 days after your receipt of the notice.

Termination of your rights under this section does not terminate the licenses of parties who have received copies or rights from you under this License. If your rights have been terminated and not permanently reinstated, you do not qualify to receive new licenses for the same material under section 10.

9. Acceptance Not Required for Having Copies.

You are not required to accept this License in order to receive or run a copy of the Program. Ancillary propagation of a covered work occurring solely as a consequence of using peer-to-peer transmission to receive a copy likewise does not require acceptance. However, nothing other than this License grants you permission to propagate or modify any covered work. These actions infringe copyright if you do not accept this License. Therefore, by modifying or propagating a covered work, you indicate your acceptance of this License to do so.

10. Automatic Licensing of Downstream Recipients.

Each time you convey a covered work, the recipient automatically receives a license from the original licensors, to run, modify and propagate that work, subject to this License. You are not responsible for enforcing compliance by third parties with this License.

An "entity transaction" is a transaction transferring control of an organization, or substantially all assets of one, or subdividing an organization, or merging organizations. If propagation of a covered work results from an entity transaction, each party to that transaction who receives a copy of the work also receives whatever licenses to the work the party's predecessor in interest had or could give under the previous paragraph, plus a right to possession of the Corresponding Source of the work from the predecessor in interest, if the predecessor has it or can get it with reasonable efforts.

You may not impose any further restrictions on the exercise of the rights granted or affirmed under this License. For example, you may not impose a license fee, royalty, or other charge for exercise of rights granted under this License, and you may not initiate litigation (including a cross-claim or counterclaim in a lawsuit) alleging that any patent claim is infringed by making, using, selling, offering for sale, or importing the Program or any portion of it.

11. Patents.

A "contributor" is a copyright holder who authorizes use under this License of the Program or a work on which the Program is based. The work thus licensed is called the contributor's "contributor version".

A contributor's "essential patent claims" are all patent claims owned or controlled by the contributor, whether already acquired or hereafter acquired, that would be infringed by some manner, permitted by this License, of making, using, or selling its contributor version, but do not include claims that would

be infringed only as a consequence of further modification of the contributor version. For purposes of this definition, "control" includes the right to grant patent sublicenses in a manner consistent with the requirements of this License.

Each contributor grants you a non-exclusive, worldwide, royalty-free patent license under the contributor's essential patent claims, to make, use, sell, offer for sale, import and otherwise run, modify and propagate the contents of its contributor version.

In the following three paragraphs, a "patent license" is any express agreement or commitment, however denominated, not to enforce a patent (such as an express permission to practice a patent or covenant not to sue for patent infringement). To "grant" such a patent license to a party means to make such an agreement or commitment not to enforce a patent against the party.

If you convey a covered work, knowingly relying on a patent license, and the Corresponding Source of the work is not available for anyone to copy, free of charge and under the terms of this License, through a publicly available network server or other readily accessible means, then you must either (1) cause the Corresponding Source to be so available, or (2) arrange to deprive yourself of the benefit of the patent license for this particular work, or (3) arrange, in a manner consistent with the requirements of this License, to extend the patent license to downstream recipients. "Knowingly relying" means you have actual knowledge that, but for the patent license, your conveying the covered work in a country, or your recipient's use of the covered work in a country, would infringe one or more identifiable patents in that country that you have reason to believe are valid.

If, pursuant to or in connection with a single transaction or arrangement, you convey, or propagate by procuring conveyance of, a covered work, and grant a patent license to some of the parties receiving the covered work authorizing them to use, propagate, modify or convey a specific copy of the covered work, then the patent license you grant is automatically extended to all recipients of the covered work and works based on it.

A patent license is "discriminatory" if it does not include within the scope of its coverage, prohibits the exercise of, or is conditioned on the non-exercise of one or more of the rights that are specifically granted under this License. You may not convey a covered work if you are a party to an arrangement with a third party that is in the business of distributing software, under which you make payment to the third party based on the extent of your activity of conveying the work, and under which the third party grants, to any of the parties who would receive the covered work from you, a discriminatory patent license (a) in connection with copies of the covered work conveyed by you (or copies made from those copies), or (b) primarily for and in connection with specific products or compilations that contain the covered work, unless you entered into that arrangement, or that patent license was granted, prior to 28 March 2007.

Nothing in this License shall be construed as excluding or limiting any implied license or other defenses to infringement that may otherwise be available to you under applicable patent law.

12. No Surrender of Others' Freedom.

If conditions are imposed on you (whether by court order, agreement or otherwise) that contradict the conditions of this License, they do not excuse you from the conditions of this License. If you cannot convey a covered work so as to satisfy simultaneously your obligations under this License and any other pertinent obligations, then as a consequence you may not convey it at all. For example, if you agree to terms that obligate you to collect a royalty for further conveying from those to whom you convey the Program, the only way you could satisfy both those terms and this License would be to refrain entirely from conveying the Program.

13. Use with the GNU Affero General Public License.

Notwithstanding any other provision of this License, you have permission to link or combine any covered work with a work licensed under version 3 of the GNU Affero General Public License into a single combined work, and to convey the resulting work. The terms of this License will continue to apply to the part which is the covered work, but the special requirements of the GNU Affero General Public License, section 13, concerning interaction through a network will apply to the combination as such.

14. Revised Versions of this License.

The Free Software Foundation may publish revised and/or new versions of the GNU General Public License from time to time. Such new versions will be similar in spirit to the present version, but may differ in detail to address new problems or concerns.

Each version is given a distinguishing version number. If the Program specifies that a certain numbered version of the GNU General Public License "or any later version" applies to it, you have the option of following the terms and conditions either of that numbered version or of any later version published by the Free Software Foundation. If the Program does not specify a version number of the GNU General Public License, you may choose any version ever published by the Free Software Foundation.

If the Program specifies that a proxy can decide which future versions of the GNU General Public License can be used, that proxy's public statement of acceptance of a version permanently authorizes you to choose that version for the Program.

Later license versions may give you additional or different permissions. However, no additional obligations are imposed on any author or copyright holder as a result of your choosing to follow a later version.

15. Disclaimer of Warranty.

THERE IS NO WARRANTY FOR THE PROGRAM, TO THE EXTENT PERMITTED BY APPLICABLE LAW. EXCEPT WHEN OTHERWISE STATED IN WRITING THE COPYRIGHT HOLDERS AND/OR OTHER PARTIES PROVIDE THE PROGRAM "AS IS" WITHOUT WARRANTY OF ANY KIND, EITHER EXPRESSED OR IMPLIED, INCLUDING, BUT NOT LIMITED TO, THE IMPLIED WARRANTIES OF MERCHANTABILITY AND FITNESS FOR A PARTICULAR PURPOSE. THE ENTIRE RISK AS TO THE QUALITY AND PERFORMANCE OF THE PROGRAM IS WITH YOU. SHOULD THE PROGRAM PROVE DEFECTIVE, YOU ASSUME THE COST OF ALL NECESSARY SERVICING, REPAIR OR CORRECTION.

16. Limitation of Liability.

IN NO EVENT UNLESS REQUIRED BY APPLICABLE LAW OR AGREED TO IN WRITING WILL ANY COPYRIGHT HOLDER, OR ANY OTHER PARTY WHO MODIFIES AND/OR CONVEYS THE PROGRAM AS PERMITTED ABOVE, BE LIABLE TO YOU FOR DAMAGES, INCLUDING ANY GENERAL, SPECIAL, INCIDENTAL OR CONSEQUENTIAL DAMAGES ARISING OUT OF THE USE OR INABILITY TO USE THE PROGRAM (INCLUDING BUT NOT LIMITED TO LOSS OF DATA OR DATA BEING RENDERED INACCURATE OR LOSSES SUSTAINED BY YOU OR THIRD PARTIES OR A FAILURE OF THE PROGRAM TO OPERATE WITH ANY OTHER PROGRAMS), EVEN IF SUCH HOLDER OR OTHER PARTY HAS BEEN ADVISED OF THE POSSIBILITY OF SUCH DAMAGES.

17. Interpretation of Sections 15 and 16.

If the disclaimer of warranty and limitation of liability provided above cannot be given local legal effect according to their terms, reviewing courts shall apply local law that most closely approximates an absolute waiver of all civil liability in connection with the Program, unless a warranty or assumption of liability accompanies a copy of the Program in return for a fee.

END OF TERMS AND CONDITIONS

How to Apply These Terms to Your New Programs

If you develop a new program, and you want it to be of the greatest possible use to the public, the best way to achieve this is to make it free software which everyone can redistribute and change under these terms.

To do so, attach the following notices to the program. It is safest to attach them to the start of each source file to most effectively state the exclusion of warranty; and each file should have at least the "copyright" line and a pointer to where the full notice is found.

```
<one line to give the program's name and a brief idea of what it does.>
Copyright (C) <year> <name of author>
```

This program is free software: you can redistribute it and/or modify it under the terms of the GNU General Public License as published by the Free Software Foundation, either version 3 of the License, or (at your option) any later version.

This program is distributed in the hope that it will be useful, but WITHOUT ANY WARRANTY; without even the implied warranty of MERCHANTABILITY or FITNESS FOR A PARTICULAR PURPOSE. See the GNU General Public License for more details.

You should have received a copy of the GNU General Public License along with this program. If not, see <http://www.gnu.org/licenses/>.

Also add information on how to contact you by electronic and paper mail.

If the program does terminal interaction, make it output a short notice like this when it starts in an interactive mode:

```
<program> Copyright (C) <year> <name of author> This program comes with
ABSOLUTELY NO WARRANTY; for details type `show w'. This is free software, and
you are welcome to redistribute it under certain conditions; type `show c'
for details.
```

The hypothetical commands `show w' and `show c' should show the appropriate parts of the General Public License. Of course, your program's commands might be different; for a GUI interface, you would use an "about box".

You should also get your employer (if you work as a programmer) or school, if any, to sign a "copyright disclaimer" for the program, if necessary. For more information on this, and how to apply and follow the GNU GPL, see <http://www.gnu.org/licenses/>.

The GNU General Public License does not permit incorporating your program into proprietary programs. If your program is a subroutine library, you may consider it more useful to permit linking proprietary applications with the library. If this is what you want to do, use the GNU Lesser General Public License instead of this License. But first, please read <http://www.gnu.org/philosophy/why-not-lgpl.html>.

libnl 1.1.4

GNU LESSER GENERAL PUBLIC LICENSE Version
2.1, February 1999

Copyright (C) 1991, 1999 Free Software Foundation, Inc. 59 Temple Place, Suite 330, Boston, MA 02111-1307 USA Everyone is permitted to copy and distribute verbatim copies of this license document, but changing it is not allowed.

[This is the first released version of the Lesser GPL. It also counts as the successor of the GNU Library Public License, version 2, hence the version number 2.1.]

Preamble

The licenses for most software are designed to take away your freedom to share and change it. By contrast, the GNU General Public Licenses are intended to guarantee your freedom to share and change free software--to make sure the software is free for all its users.

This license, the Lesser General Public License, applies to some specially designated software packages--typically libraries--of the Free Software Foundation and other authors who decide to use it. You can use it too, but we suggest you first think carefully about whether this license or the ordinary General Public License is the better strategy to use in any particular case, based on the explanations below.

When we speak of free software, we are referring to freedom of use, not price. Our General Public Licenses are designed to make sure that you have the freedom to distribute copies of free software (and charge for this service if you wish); that you receive source code or can get it if you want it; that you can change the software and use pieces of it in new free programs; and that you are informed that you can do these things.

To protect your rights, we need to make restrictions that forbid distributors to deny you these rights or to ask you to surrender these rights. These restrictions translate to certain responsibilities for you if you distribute copies of the library or if you modify it.

For example, if you distribute copies of the library, whether gratis or for a fee, you must give the recipients all the rights that we gave you. You must make sure that they, too, receive or can get the source code. If you link other code with the library, you must provide complete object files to the recipients, so that they can relink them with the library after making changes to the library and recompiling it. And you must show them these terms so they know their rights.

We protect your rights with a two-step method: (1) we copyright the library, and (2) we offer you this license, which gives you legal permission to copy, distribute and/or modify the library.

To protect each distributor, we want to make it very clear that there is no warranty for the free library. Also, if the library is modified by someone else and passed on, the recipients should know that what they have is not the original version, so that the original author's reputation will not be affected by problems that might be introduced by others.

Finally, software patents pose a constant threat to the existence of any free program. We wish to make sure that a company cannot effectively restrict the users of a free program by obtaining a restrictive license from a patent holder. Therefore, we insist that any patent license obtained for a version of the library must be consistent with the full freedom of use specified in this license.

Most GNU software, including some libraries, is covered by the ordinary GNU General Public License. This license, the GNU Lesser General Public License, applies to certain designated libraries, and is quite different from the ordinary General Public License. We use this license for certain libraries in order to permit linking those libraries into non-free programs.

When a program is linked with a library, whether statically or using a shared library, the combination of the two is legally speaking a combined work, a derivative of the original library. The ordinary General Public License therefore permits such linking only if the entire combination fits its criteria of freedom. The Lesser General Public License permits more lax criteria for linking other code with the library.

We call this license the "Lesser" General Public License because it does less to protect the user's freedom than the ordinary General Public License. It also provides other free software developers less of an advantage over competing non-free programs. These disadvantages are the reason we use the ordinary General Public License for many libraries. However, the Lesser license provides advantages in certain special circumstances.

For example, on rare occasions, there may be a special need to encourage the widest possible use of a certain library, so that it becomes a de-facto standard. To achieve this, non-free programs must be allowed to use the library. A more frequent case is that a free library does the same job as widely used non-free libraries. In this case, there is little to gain by limiting the free library to free software only, so we use the Lesser General Public License.

In other cases, permission to use a particular library in non-free programs enables a greater number of people to use a large body of free software. For example, permission to use the GNU C Library in non-free programs enables many more people to use the whole GNU operating system, as well as its variant, the GNU/Linux operating system.

Although the Lesser General Public License is Less protective of the users' freedom, it does ensure that the user of a program that is linked with the Library has the freedom and the wherewithal to run that program using a modified version of the Library.

The precise terms and conditions for copying, distribution and modification follow. Pay close attention to the difference between a "work based on the library" and a "work that uses the library". The former contains code derived from the library, whereas the latter must be combined with the library in order to run.

GNU LESSER GENERAL PUBLIC LICENSE TERMS AND CONDITIONS FOR
COPYING, DISTRIBUTION AND MODIFICATION

0. This License Agreement applies to any software library or other program which contains a notice placed by the copyright holder or other authorized party saying it may be distributed under the terms of this Lesser General Public License (also called "this License"). Each licensee is addressed as "you".

A "library" means a collection of software functions and/or data prepared so as to be conveniently linked with application programs (which use some of those functions and data) to form executables.

The "Library", below, refers to any such software library or work which has been distributed under these terms. A "work based on the Library" means either the Library or any derivative work under copyright law: that is to say, a work containing the Library or a portion of it, either verbatim or with modifications and/or translated straightforwardly into another language. (Hereinafter, translation is included without limitation in the term "modification".)

"Source code" for a work means the preferred form of the work for making modifications to it. For a library, complete source code means all the source code for all modules it contains, plus any associated interface definition files, plus the scripts used to control compilation and installation of the library.

Activities other than copying, distribution and modification are not covered by this License; they are outside its scope. The act of running a program using the Library is not restricted, and output from such a program is covered only if its contents constitute a work based on the Library (independent of the use of the Library in a tool for writing it). Whether that is true depends on what the Library does and what the program that uses the Library does.

1. You may copy and distribute verbatim copies of the Library's complete source code as you receive it, in any medium, provided that you conspicuously and appropriately publish on each copy an appropriate copyright notice and disclaimer of warranty; keep intact all the notices that refer to this License and to the absence of any warranty; and distribute a copy of this License along with the Library.

You may charge a fee for the physical act of transferring a copy, and you may at your option offer warranty protection in exchange for a fee.

2. You may modify your copy or copies of the Library or any portion of it, thus forming a work based on the Library, and copy and distribute such modifications or work under the terms of Section 1 above, provided that you also meet all of these conditions:

a) The modified work must itself be a software library.

b) You must cause the files modified to carry prominent notices stating that you changed the files and the date of any change.

c) You must cause the whole of the work to be licensed at no charge to all third parties under the terms of this License.

d) If a facility in the modified Library refers to a function or a table of data to be supplied by an application program that uses the facility, other than as an argument passed when the facility is invoked, then you must make a good faith effort to ensure that, in the event an application does not supply such function or table, the facility still operates, and performs whatever part of its purpose remains meaningful.

(For example, a function in a library to compute square roots has a purpose that is entirely well-defined independent of the application. Therefore, Subsection 2d requires that any application-supplied function or table used by this function must be optional: if the application does not supply it, the square root function must still compute square roots.)

These requirements apply to the modified work as a whole. If identifiable sections of that work are not derived from the Library, and can be reasonably considered independent and separate works in themselves, then this License, and its terms, do not apply to those sections when you distribute them as separate works. But when you distribute the same sections as part of a whole which is a work based on the Library, the distribution of the whole must be on the terms of this License, whose permissions for other licensees extend to the entire whole, and thus to each and every part regardless of who wrote it.

Thus, it is not the intent of this section to claim rights or contest your rights to work written entirely by you; rather, the intent is to exercise the right to control the distribution of derivative or collective works based on the Library.

In addition, mere aggregation of another work not based on the Library with the Library (or with a work based on the Library) on a volume of a storage or distribution medium does not bring the other work under the scope of this License.

3. You may opt to apply the terms of the ordinary GNU General Public License instead of this License to a given copy of the Library. To do this, you must alter all the notices that refer to this License, so that they refer to the ordinary GNU General Public License, version 2, instead of to this License. (If a newer version than version 2 of the ordinary GNU General Public License has appeared, then you can specify that version instead if you wish.) Do not make any other change in these notices.

Once this change is made in a given copy, it is irreversible for that copy, so the ordinary GNU General Public License applies to all subsequent copies and derivative works made from that copy.

This option is useful when you wish to copy part of the code of the Library into a program that is not a library.

4. You may copy and distribute the Library (or a portion or derivative of it, under Section 2) in object code or executable form under the terms of Sections 1 and 2 above provided that you accompany it with the complete corresponding machine-readable source code, which must be distributed under the terms of Sections 1 and 2 above on a medium customarily used for software interchange.

If distribution of object code is made by offering access to copy from a designated place, then offering equivalent access to copy the source code from the same place satisfies the requirement to distribute the source code, even though third parties are not compelled to copy the source along with the object code.

5. A program that contains no derivative of any portion of the Library, but is designed to work with the Library by being compiled or linked with it, is called a "work that uses the Library". Such a work, in isolation, is not a derivative work of the Library, and therefore falls outside the scope of this License.

However, linking a "work that uses the Library" with the Library creates an executable that is a derivative of the Library (because it contains portions of the Library), rather than a "work that uses the library". The executable is therefore covered by this License. Section 6 states terms for distribution of such executables.

When a "work that uses the Library" uses material from a header file that is part of the Library, the object code for the work may be a derivative work of the Library even though the source code is not. Whether this is true is especially significant if the work can be linked without the Library, or if the work is itself a library. The threshold for this to be true is not precisely defined by law.

If such an object file uses only numerical parameters, data structure layouts and accessors, and small macros and small inline functions (ten lines or less in length), then the use of the object file is unrestricted, regardless of whether it is legally a derivative work. (Executables containing this object code plus portions of the Library will still fall under Section 6.)

Otherwise, if the work is a derivative of the Library, you may distribute the object code for the work under the terms of Section 6. Any executables containing that work also fall under Section 6, whether or not they are linked directly with the Library itself.

6. As an exception to the Sections above, you may also combine or link a "work that uses the Library" with the Library to produce a work containing portions of the Library, and distribute that work under terms of your choice, provided that the terms permit modification of the work for the customer's own use and reverse engineering for debugging such modifications.

You must give prominent notice with each copy of the work that the Library is used in it and that the Library and its use are covered by this License. You must supply a copy of this License. If the work during execution displays copyright notices, you must include the copyright notice for the Library among them, as well as a reference directing the user to the copy of this License. Also, you must do one of these things:

a) Accompany the work with the complete corresponding machine-readable source code for the Library including whatever changes were used in the work (which must be distributed under Sections 1 and 2 above); and, if the work is an executable linked with the Library, with the complete machine-readable "work that uses the Library", as object code and/or source code, so that the user can modify the Library and then relink to produce a modified executable containing the modified Library. (It is understood that the user who changes the contents of definitions files in the Library will not necessarily be able to recompile the application to use the modified definitions.)

b) Use a suitable shared library mechanism for linking with the Library. A suitable mechanism is one that (1) uses at run time a copy of the library already present on the user's computer system, rather than copying library functions into the executable, and (2) will operate properly with a modified version of the library, if the user installs one, as long as the modified version is interface-compatible with the version that the work was made with.

c) Accompany the work with a written offer, valid for at least three years, to give the same user the materials specified in Subsection 6a, above, for a charge no more than the cost of performing this distribution.

d) If distribution of the work is made by offering access to copy from a designated place, offer equivalent access to copy the above specified materials from the same place.

e) Verify that the user has already received a copy of these materials or that you have already sent this user a copy.

For an executable, the required form of the "work that uses the Library" must include any data and utility programs needed for reproducing the executable from it. However, as a special exception, the materials to be distributed need not include anything that is normally distributed (in either source or binary form) with the major components (compiler, kernel, and so on) of the operating system on which the executable runs, unless that component itself accompanies the executable.

It may happen that this requirement contradicts the license restrictions of other proprietary libraries that do not normally accompany the operating system. Such a contradiction means you cannot use both them and the Library together in an executable that you distribute.

7. You may place library facilities that are a work based on the Library side-by-side in a single library together with other library facilities not covered by this License, and distribute such a combined library, provided that the separate distribution of the work based on the Library and of the other library facilities is otherwise permitted, and provided that you do these two things:

a) Accompany the combined library with a copy of the same work based on the Library, uncombined with any other library facilities. This must be distributed under the terms of the Sections above.

b) Give prominent notice with the combined library of the fact that part of it is a work based on the Library, and explaining where to find the accompanying uncombined form of the same work.

8. You may not copy, modify, sublicense, link with, or distribute the Library except as expressly provided under this License. Any attempt otherwise to copy, modify, sublicense, link with, or distribute the Library is void, and will automatically terminate your rights under this License. However, parties who have received copies, or rights, from you under this License will not have their licenses terminated so long as such parties remain in full compliance.

9. You are not required to accept this License, since you have not signed it. However, nothing else grants you permission to modify or distribute the Library or its derivative works. These actions are prohibited by law if you do not accept this License. Therefore, by modifying or distributing the Library (or any work based on the Library), you indicate your acceptance of this License to do so, and all its terms and conditions for copying, distributing or modifying the Library or works based on it.

10. Each time you redistribute the Library (or any work based on the Library), the recipient automatically receives a license from the original licensor to copy, distribute, link with or modify the Library subject to these terms and conditions. You may not impose any further restrictions on the recipients' exercise of the rights granted herein. You are not responsible for enforcing compliance by third parties with this License.

11. If, as a consequence of a court judgment or allegation of patent infringement or for any other reason (not limited to patent issues), conditions are imposed on you (whether by court order, agreement or otherwise) that contradict the conditions of this License, they do not excuse you from the conditions of this License. If you cannot distribute so as to satisfy simultaneously your obligations under this License and any other pertinent obligations, then as a consequence you may not distribute the Library at all. For example, if a patent license would not permit royalty-free redistribution of the Library by all those who receive copies directly or indirectly through you, then the only way you could satisfy both it and this License would be to refrain entirely from distribution of the Library.

If any portion of this section is held invalid or unenforceable under any particular circumstance, the balance of the section is intended to apply, and the section as a whole is intended to apply in other circumstances.

It is not the purpose of this section to induce you to infringe any patents or other property right claims or to contest validity of any such claims; this section has the sole purpose of protecting the integrity of the free software distribution system which is implemented by public license practices. Many people have made generous contributions to the wide range of software distributed through that system in reliance on consistent application of that system; it is up to the author/donor to decide if he or she is willing to distribute software through any other system and a licensee cannot impose that choice.

This section is intended to make thoroughly clear what is believed to be a consequence of the rest of this License.

12. If the distribution and/or use of the Library is restricted in certain countries either by patents or by copyrighted interfaces, the original copyright holder who places the Library under this License may add an explicit geographical distribution limitation excluding those countries, so that distribution is permitted only in or among countries not thus excluded. In such case, this License incorporates the limitation as if written in the body of this License.

13. The Free Software Foundation may publish revised and/or new versions of the Lesser General Public License from time to time. Such new versions will be similar in spirit to the present version, but may differ in detail to address new problems or concerns.

Each version is given a distinguishing version number. If the Library specifies a version number of this License which applies to it and "any later version", you have the option of following the terms and conditions either of that version or of any later version published by the Free Software Foundation. If the Library does not specify a license version number, you may choose any version ever published by the Free Software Foundation.

14. If you wish to incorporate parts of the Library into other free programs whose distribution conditions are incompatible with these, write to the author to ask for permission. For software which is copyrighted by the Free Software Foundation, write to the Free Software Foundation; we sometimes make exceptions for this. Our decision will be guided by the two goals of preserving the free status of all derivatives of our free software and of promoting the sharing and reuse of software generally.

NO WARRANTY

15. BECAUSE THE LIBRARY IS LICENSED FREE OF CHARGE, THERE IS NO WARRANTY FOR THE LIBRARY, TO THE EXTENT PERMITTED BY APPLICABLE LAW. EXCEPT WHEN OTHERWISE STATED IN WRITING THE COPYRIGHT HOLDERS AND/OR OTHER PARTIES PROVIDE THE LIBRARY "AS IS" WITHOUT WARRANTY OF ANY KIND, EITHER EXPRESSED OR IMPLIED, INCLUDING, BUT NOT LIMITED TO, THE IMPLIED WARRANTIES OF MERCHANTABILITY AND FITNESS FOR A PARTICULAR PURPOSE. THE ENTIRE RISK AS TO THE QUALITY AND PERFORMANCE OF THE LIBRARY IS WITH YOU. SHOULD THE LIBRARY PROVE DEFECTIVE, YOU ASSUME THE COST OF ALL NECESSARY SERVICING, REPAIR OR CORRECTION.

16. IN NO EVENT UNLESS REQUIRED BY APPLICABLE LAW OR AGREED TO IN WRITING WILL ANY COPYRIGHT HOLDER, OR ANY OTHER PARTY WHO MAY MODIFY AND/OR REDISTRIBUTE THE LIBRARY AS PERMITTED ABOVE, BE LIABLE TO YOU FOR DAMAGES, INCLUDING ANY GENERAL, SPECIAL, INCIDENTAL OR CONSEQUENTIAL DAMAGES ARISING OUT OF THE USE OR INABILITY TO USE THE LIBRARY (INCLUDING BUT NOT LIMITED TO LOSS OF DATA OR DATA BEING RENDERED INACCURATE OR LOSSES SUSTAINED BY YOU OR THIRD PARTIES OR A FAILURE OF THE LIBRARY TO OPERATE WITH ANY OTHER SOFTWARE), EVEN IF SUCH HOLDER OR OTHER PARTY HAS BEEN ADVISED OF THE POSSIBILITY OF SUCH DAMAGES.

END OF TERMS AND CONDITIONS

linux 3.8.13

NOTE! This copyright does **not** cover user programs that use kernel services by normal system calls - this is merely considered normal use of the kernel, and does **not** fall under the heading of "derived work". Also note that the GPL below is copyrighted by the Free Software Foundation, but the instance of code that it refers to (the Linux kernel) is copyrighted by me and others who actually wrote it.

Also note that the only valid version of the GPL as far as the kernel is concerned is this particular version of the license (ie v2, not v2.2 or v3.x or whatever), unless explicitly otherwise stated.

Linus Torvalds

GNU GENERAL PUBLIC LICENSE Version 2, June 1991

Copyright (C) 1989, 1991 Free Software Foundation, Inc. 51
Franklin St, Fifth Floor, Boston, MA 02110-1301 USA Everyone is permitted to
copy and distribute verbatim copies of this license document, but changing it is
not allowed.

Preamble

The licenses for most software are designed to take away your freedom to share and change it. By contrast, the GNU General Public License is intended to guarantee your freedom to share and change free software--to make sure the software is free for all its users. This General Public License applies to most of the Free Software Foundation's software and to any other program whose authors commit to using it. (Some other Free Software Foundation software is covered by the GNU Library General Public License instead.) You can apply it to your programs, too.

When we speak of free software, we are referring to freedom, not price. Our General Public Licenses are designed to make sure that you have the freedom to distribute copies of free software (and charge for this service if you wish), that you receive source code or can get it if you want it, that you can change the software or use pieces of it in new free programs; and that you know you can do these things.

To protect your rights, we need to make restrictions that forbid anyone to deny you these rights or to ask you to surrender the rights. These restrictions translate to certain responsibilities for you if you distribute copies of the software, or if you modify it.

For example, if you distribute copies of such a program, whether gratis or for a fee, you must give the recipients all the rights that you have. You must make sure that they, too, receive or can get the source code. And you must show them these terms so they know their rights.

We protect your rights with two steps: (1) copyright the software, and (2) offer you this license which gives you legal permission to copy, distribute and/or modify the software.

Also, for each author's protection and ours, we want to make certain that everyone understands that there is no warranty for this free software. If the software is modified by someone else and passed on, we want its recipients to know that what they have is not the original, so that any problems introduced by others will not reflect on the original authors' reputations.

Finally, any free program is threatened constantly by software patents. We wish to avoid the danger that redistributors of a free program will individually obtain patent licenses, in effect making the program proprietary. To prevent this, we have made it clear that any patent must be licensed for everyone's free use or not licensed at all.

The precise terms and conditions for copying, distribution and modification follow.

GNU GENERAL PUBLIC LICENSE
TERMS AND CONDITIONS FOR COPYING, DISTRIBUTION AND MODIFICATION

0. This License applies to any program or other work which contains a notice placed by the copyright holder saying it may be distributed under the terms of this General Public License. The "Program", below, refers to any such program or work, and a "work based on the Program" means either the Program or any derivative work under copyright law: that is to say, a work containing the Program or a portion of it, either verbatim or with modifications and/or translated into another language. (Hereinafter, translation is included without limitation in the term "modification".) Each licensee is addressed as "you".

Activities other than copying, distribution and modification are not covered by this License; they are outside its scope. The act of running the Program is not restricted, and the output from the Program is covered only if its contents constitute a work based on the Program (independent of having been made by running the Program). Whether that is true depends on what the Program does.

1. You may copy and distribute verbatim copies of the Program's source code as you receive it, in any medium, provided that you conspicuously and appropriately publish on each copy an appropriate copyright notice and disclaimer of warranty; keep intact all the notices that refer to this License and to the absence of any warranty; and give any other recipients of the Program a copy of this License along with the Program.

You may charge a fee for the physical act of transferring a copy, and you may at your option offer warranty protection in exchange for a fee.

2. You may modify your copy or copies of the Program or any portion of it, thus forming a work based on the Program, and copy and distribute such modifications or work under the terms of Section 1 above, provided that you also meet all of these conditions:

a) You must cause the modified files to carry prominent notices stating that you changed the files and the date of any change.

b) You must cause any work that you distribute or publish, that in whole or in part contains or is derived from the Program or any part thereof, to be licensed as a whole at no charge to all third parties under the terms of this License.

c) If the modified program normally reads commands interactively when run, you must cause it, when started running for such interactive use in the most ordinary way, to print or display an announcement including an appropriate copyright notice and a notice that there is no warranty (or else, saying that you provide a warranty) and that users may redistribute the program under these conditions, and telling the user how to view a copy of this License. (Exception: if the Program itself is interactive but does not normally print such an announcement, your work based on the Program is not required to print an announcement.)

These requirements apply to the modified work as a whole. If identifiable sections of that work are not derived from the Program, and can be reasonably considered independent and separate works in themselves, then this License, and its terms, do not apply to those sections when you distribute them as separate works. But when you distribute the same sections as part of a whole which is a work based on the Program, the distribution of the whole must be on the terms of this License, whose permissions for other licensees extend to the entire whole, and thus to each and every part regardless of who wrote it.

Thus, it is not the intent of this section to claim rights or contest your rights to work written entirely by you; rather, the intent is to exercise the right to control the distribution of derivative or collective works based on the Program.

In addition, mere aggregation of another work not based on the Program with the Program (or with a work based on the Program) on a volume of a storage or distribution medium does not bring the other work under the scope of this License.

3. You may copy and distribute the Program (or a work based on it, under Section 2) in object code or executable form under the terms of Sections 1 and 2 above provided that you also do one of the following:

a) Accompany it with the complete corresponding machine-readable source code, which must be distributed under the terms of Sections 1 and 2 above on a medium customarily used for software interchange; or,

b) Accompany it with a written offer, valid for at least three years, to give any third party, for a charge no more than your cost of physically performing source distribution, a complete machine-readable copy of the corresponding source code, to be distributed under the terms of Sections 1 and 2 above on a medium customarily used for software interchange; or,

c) Accompany it with the information you received as to the offer to distribute corresponding source code. (This alternative is allowed only for noncommercial distribution and only if you received the program in object code or executable form with such an offer, in accord with Subsection b above.)

The source code for a work means the preferred form of the work for making modifications to it. For an executable work, complete source code means all the source code for all modules it contains, plus any associated interface definition files, plus the scripts used to control compilation and installation of the executable. However, as a special exception, the source code distributed need not include anything that is normally distributed (in either source or binary form) with the major components (compiler, kernel, and so on) of the operating system on which the executable runs, unless that component itself accompanies the executable.

If distribution of executable or object code is made by offering access to copy from a designated place, then offering equivalent access to copy the source code from the same place counts as distribution of the source code, even though third parties are not compelled to copy the source along with the object code.

4. You may not copy, modify, sublicense, or distribute the Program except as expressly provided under this License. Any attempt otherwise to copy, modify, sublicense or distribute the Program is void, and will automatically terminate your rights under this License. However, parties who have received copies, or rights, from you under this License will not have their licenses terminated so long as such parties remain in full compliance.

5. You are not required to accept this License, since you have not signed it. However, nothing else grants you permission to modify or distribute the Program or its derivative works. These actions are prohibited by law if you do not accept this License. Therefore, by modifying or distributing the Program (or any work based on the Program), you indicate your acceptance of this License to do so, and all its terms and conditions for copying, distributing or modifying the Program or works based on it.

6. Each time you redistribute the Program (or any work based on the Program), the recipient automatically receives a license from the original licensor to copy, distribute or modify the Program subject to these terms and conditions. You may not impose any further restrictions on the recipients' exercise of the rights granted herein. You are not responsible for enforcing compliance by third parties to this License.

7. If, as a consequence of a court judgment or allegation of patent infringement or for any other reason (not limited to patent issues), conditions are imposed on you (whether by court order, agreement or otherwise) that contradict the conditions of this License, they do not excuse you from the conditions of this License. If you cannot distribute so as to satisfy simultaneously your obligations under this License and any other pertinent obligations, then as a consequence you may not distribute the Program at all. For example, if a patent

license would not permit royalty-free redistribution of the Program by all those who receive copies directly or indirectly through you, then the only way you could satisfy both it and this License would be to refrain entirely from distribution of the Program.

If any portion of this section is held invalid or unenforceable under any particular circumstance, the balance of the section is intended to apply and the section as a whole is intended to apply in other circumstances.

It is not the purpose of this section to induce you to infringe any patents or other property right claims or to contest validity of any such claims; this section has the sole purpose of protecting the integrity of the free software distribution system, which is implemented by public license practices. Many people have made generous contributions to the wide range of software distributed through that system in reliance on consistent application of that system; it is up to the author/donor to decide if he or she is willing to distribute software through any other system and a licensee cannot impose that choice.

This section is intended to make thoroughly clear what is believed to be a consequence of the rest of this License.

8. If the distribution and/or use of the Program is restricted in certain countries either by patents or by copyrighted interfaces, the original copyright holder who places the Program under this License may add an explicit geographical distribution limitation excluding those countries, so that distribution is permitted only in or among countries not thus excluded. In such case, this License incorporates the limitation as if written in the body of this License.

9. The Free Software Foundation may publish revised and/or new versions of the General Public License from time to time. Such new versions will be similar in spirit to the present version, but may differ in detail to address new problems or concerns.

Each version is given a distinguishing version number. If the Program specifies a version number of this License which applies to it and "any later version", you have the option of following the terms and conditions either of that version or of any later version published by the Free Software Foundation. If the Program does not specify a version number of this License, you may choose any version ever published by the Free Software Foundation.

10. If you wish to incorporate parts of the Program into other free programs whose distribution conditions are different, write to the author to ask for permission. For software which is copyrighted by the Free Software Foundation, write to the Free Software Foundation; we sometimes make exceptions for this. Our decision will be guided by the two goals of preserving the free status of all derivatives of our free software and of promoting the sharing and reuse of software generally.

NO WARRANTY

11. BECAUSE THE PROGRAM IS LICENSED FREE OF CHARGE, THERE IS NO WARRANTY FOR THE PROGRAM, TO THE EXTENT PERMITTED BY APPLICABLE LAW. EXCEPT WHEN OTHERWISE STATED IN WRITING THE COPYRIGHT HOLDERS AND/OR OTHER PARTIES PROVIDE THE PROGRAM "AS IS" WITHOUT WARRANTY OF ANY KIND, EITHER EXPRESSED OR IMPLIED, INCLUDING, BUT NOT LIMITED TO, THE IMPLIED WARRANTIES OF MERCHANTABILITY AND FITNESS FOR A PARTICULAR PURPOSE. THE ENTIRE RISK AS TO THE QUALITY AND PERFORMANCE OF THE PROGRAM IS WITH YOU. SHOULD THE PROGRAM PROVE DEFECTIVE, YOU ASSUME THE COST OF ALL NECESSARY SERVICING, REPAIR OR CORRECTION.

12. IN NO EVENT UNLESS REQUIRED BY APPLICABLE LAW OR AGREED TO IN WRITING WILL ANY COPYRIGHT HOLDER, OR ANY OTHER PARTY WHO MAY MODIFY AND/OR REDISTRIBUTE THE PROGRAM AS PERMITTED ABOVE, BE LIABLE TO YOU FOR DAMAGES, INCLUDING ANY GENERAL, SPECIAL, INCIDENTAL OR CONSEQUENTIAL DAMAGES ARISING OUT OF THE USE OR INABILITY TO USE THE PROGRAM (INCLUDING BUT NOT LIMITED TO LOSS OF DATA OR DATA BEING RENDERED INACCURATE OR LOSSES SUSTAINED BY YOU OR THIRD PARTIES OR A FAILURE OF THE PROGRAM TO OPERATE WITH ANY OTHER PROGRAMS), EVEN IF SUCH HOLDER OR OTHER PARTY HAS BEEN ADVISED OF THE POSSIBILITY OF SUCH DAMAGES.

END OF TERMS AND CONDITIONS

How to Apply These Terms to Your New Programs

If you develop a new program, and you want it to be of the greatest possible use to the public, the best way to achieve this is to make it free software which everyone can redistribute and change under these terms.

To do so, attach the following notices to the program. It is safest to attach them to the start of each source file to most effectively convey the exclusion of warranty; and each file should have at least the "copyright" line and a pointer to where the full notice is found.

```
<one line to give the program's name and a brief idea of what it does.>
Copyright (C) <year> <name of author>
```

This program is free software; you can redistribute it and/or modify it under the terms of the GNU General Public License as published by the Free Software Foundation; either version 2 of the License, or (at your option) any later version.

This program is distributed in the hope that it will be useful, but WITHOUT ANY WARRANTY; without even the implied warranty of MERCHANTABILITY or FITNESS FOR A PARTICULAR PURPOSE. See the GNU General Public License for more details.

You should have received a copy of the GNU General Public License along with this program; if not, write to the Free Software Foundation, Inc., 51 Franklin St, Fifth Floor, Boston, MA 02110-1301 USA

Also add information on how to contact you by electronic and paper mail.

If the program is interactive, make it output a short notice like this when it starts in an interactive mode:

```
Gnomovision version 69, Copyright (C) year name of author Gnomovision
comes with ABSOLUTELY NO WARRANTY; for details type `show w'. This is free
software, and you are welcome to redistribute it under certain conditions;
type `show c' for details.
```

The hypothetical commands `show w' and `show c' should show the appropriate parts of the General Public License. Of course, the commands you use may be called something other than `show w' and `show c'; they could even be mouse-clicks or menu items--whatever suits your program.

You should also get your employer (if you work as a programmer) or your school, if any, to sign a "copyright disclaimer" for the program, if necessary. Here is a sample; alter the names:

```
Yoyodyne, Inc., hereby disclaims all copyright interest in the program
`Gnomovision' (which makes passes at compilers) written by James Hacker.
```

```
<signature of Ty Coon>, 1 April 1989 Ty Coon, President of Vice
```

This General Public License does not permit incorporating your program into proprietary programs. If your program is a subroutine library, you may consider it more useful to permit linking proprietary applications with the library. If this is what you want to do, use the GNU Library General Public License instead of this License.

lua 5.1.4

Lua License -----

Lua is licensed under the terms of the MIT license reproduced below. This means that Lua is free software and can be used for both academic and commercial purposes at absolutely no cost.

For details and rationale, see <http://www.lua.org/license.html> .

=====
 Copyright (C) 1994-2008 Lua.org, PUC-Rio.

Permission is hereby granted, free of charge, to any person obtaining a copy of this software and associated documentation files (the "Software"), to deal in the Software without restriction, including without limitation the rights to use, copy, modify, merge, publish, distribute, sublicense, and/or sell copies of the Software, and to permit persons to whom the Software is furnished to do so, subject to the following conditions:

The above copyright notice and this permission notice shall be included in all copies or substantial portions of the Software.

THE SOFTWARE IS PROVIDED "AS IS", WITHOUT WARRANTY OF ANY KIND, EXPRESS OR IMPLIED, INCLUDING BUT NOT LIMITED TO THE WARRANTIES OF MERCHANTABILITY, FITNESS FOR A PARTICULAR PURPOSE AND NONINFRINGEMENT. IN NO EVENT SHALL THE AUTHORS OR COPYRIGHT HOLDERS BE LIABLE FOR ANY CLAIM, DAMAGES OR OTHER LIABILITY, WHETHER IN AN ACTION OF CONTRACT, TORT OR OTHERWISE, ARISING FROM, OUT OF OR IN CONNECTION WITH THE SOFTWARE OR THE USE OR OTHER DEALINGS IN THE SOFTWARE.

=====
 (end of COPYRIGHT)

lua-cjson 2.1.0

Copyright (c) 2010-2012 Mark Pulford <mark@kyne.com.au>

Permission is hereby granted, free of charge, to any person obtaining a copy of this software and associated documentation files (the "Software"), to deal in the Software without restriction, including without limitation the rights to use, copy, modify, merge, publish, distribute, sublicense, and/or sell copies of the Software, and to permit persons to whom the Software is furnished to do so, subject to the following conditions:

The above copyright notice and this permission notice shall be included in all copies or substantial portions of the Software.

THE SOFTWARE IS PROVIDED "AS IS", WITHOUT WARRANTY OF ANY KIND, EXPRESS OR IMPLIED, INCLUDING BUT NOT LIMITED TO THE WARRANTIES OF MERCHANTABILITY, FITNESS FOR A PARTICULAR PURPOSE AND NONINFRINGEMENT. IN NO EVENT SHALL THE AUTHORS OR COPYRIGHT HOLDERS BE LIABLE FOR ANY CLAIM, DAMAGES OR OTHER LIABILITY, WHETHER IN AN ACTION OF CONTRACT, TORT OR OTHERWISE, ARISING FROM, OUT OF OR IN CONNECTION WITH THE SOFTWARE OR THE USE OR OTHER DEALINGS IN THE SOFTWARE.

luafilesystem 1.5.0

Lua License -----

Lua is licensed under the terms of the MIT license reproduced below. This means that Lua is free software and can be used for both academic and commercial purposes at absolutely no cost.

For details and rationale, see <http://www.lua.org/license.html> .

Copyright (C) 1994-2008 Lua.org, PUC-Rio.

Permission is hereby granted, free of charge, to any person obtaining a copy of this software and associated documentation files (the "Software"), to deal in the Software without restriction, including without limitation the rights to use, copy, modify, merge, publish, distribute, sublicense, and/or sell copies of the Software, and to permit persons to whom the Software is furnished to do so, subject to the following conditions:

The above copyright notice and this permission notice shall be included in all copies or substantial portions of the Software.

THE SOFTWARE IS PROVIDED "AS IS", WITHOUT WARRANTY OF ANY KIND, EXPRESS OR IMPLIED, INCLUDING BUT NOT LIMITED TO THE WARRANTIES OF MERCHANTABILITY, FITNESS FOR A PARTICULAR PURPOSE AND NONINFRINGEMENT. IN NO EVENT SHALL THE AUTHORS OR COPYRIGHT HOLDERS BE LIABLE FOR ANY CLAIM, DAMAGES OR OTHER LIABILITY, WHETHER IN AN ACTION OF CONTRACT, TORT OR OTHERWISE, ARISING FROM, OUT OF OR IN CONNECTION WITH THE SOFTWARE OR THE USE OR OTHER DEALINGS IN THE SOFTWARE.

=====

(end of COPYRIGHT)

mootools 1.4.5

The MIT License

Copyright (c) 2006-2014 Valerio Proietti, <<http://mad4milk.net/>>

Permission is hereby granted, free of charge, to any person obtaining a copy of this software and associated documentation files (the "Software"), to deal in the Software without restriction, including without limitation the rights to use, copy, modify, merge, publish, distribute, sublicense, and/or sell copies of the Software, and to permit persons to whom the Software is furnished to do so, subject to the following conditions:

The above copyright notice and this permission notice shall be included in all copies or substantial portions of the Software.

THE SOFTWARE IS PROVIDED "AS IS", WITHOUT WARRANTY OF ANY KIND, EXPRESS OR IMPLIED, INCLUDING BUT NOT LIMITED TO THE WARRANTIES OF MERCHANTABILITY, FITNESS FOR A PARTICULAR PURPOSE AND NONINFRINGEMENT. IN NO EVENT SHALL THE AUTHORS OR COPYRIGHT HOLDERS BE LIABLE FOR ANY CLAIM, DAMAGES OR OTHER LIABILITY, WHETHER IN AN ACTION OF CONTRACT, TORT OR OTHERWISE, ARISING FROM, OUT OF OR IN CONNECTION WITH THE SOFTWARE OR THE USE OR OTHER DEALINGS IN THE SOFTWARE.

mootools-more 1.4.0.1

The MIT License

Copyright (c) 2006-2014 Valerio Proietti, <<http://mad4milk.net/>>

Permission is hereby granted, free of charge, to any person obtaining a copy of this software and associated documentation files (the "Software"), to deal in the Software without restriction, including without limitation the rights to use, copy, modify, merge, publish, distribute, sublicense, and/or sell copies of the Software, and to permit persons to whom the Software is furnished to do so, subject to the following conditions:

The above copyright notice and this permission notice shall be included in all copies or substantial portions of the Software.

THE SOFTWARE IS PROVIDED "AS IS", WITHOUT WARRANTY OF ANY KIND, EXPRESS OR IMPLIED, INCLUDING BUT NOT LIMITED TO THE WARRANTIES OF MERCHANTABILITY, FITNESS FOR A PARTICULAR PURPOSE AND NONINFRINGEMENT. IN NO EVENT SHALL THE AUTHORS OR COPYRIGHT HOLDERS BE LIABLE FOR ANY CLAIM, DAMAGES OR OTHER LIABILITY, WHETHER IN AN ACTION OF CONTRACT, TORT OR OTHERWISE, ARISING FROM, OUT OF OR IN CONNECTION WITH THE SOFTWARE OR THE USE OR OTHER DEALINGS IN THE SOFTWARE.

ncurses 5.7

```
-----
-- Copyright (c) 2006 Free Software Foundation, Inc. --
--
-- Permission is hereby granted, free of charge, to any person obtaining a --
-- copy of this software and associated documentation files (the --
-- "Software"), to deal in the Software without restriction, including --
-- without limitation the rights to use, copy, modify, merge, publish, --
-- distribute, distribute with modifications, sublicense, and/or sell copies --
-- of the Software, and to permit persons to whom the Software is furnished --
-- to do so, subject to the following conditions: --
--
-- The above copyright notice and this permission notice shall be included --
-- in all copies or substantial portions of the Software. --
--
-- THE SOFTWARE IS PROVIDED "AS IS", WITHOUT WARRANTY OF ANY KIND, EXPRESS --
-- OR IMPLIED, INCLUDING BUT NOT LIMITED TO THE WARRANTIES OF --
-- MERCHANTABILITY, FITNESS FOR A PARTICULAR PURPOSE AND NONINFRINGEMENT. IN --
-- NO EVENT SHALL THE ABOVE COPYRIGHT HOLDERS BE LIABLE FOR ANY CLAIM, --
-- DAMAGES OR OTHER LIABILITY, WHETHER IN AN ACTION OF CONTRACT, TORT OR --
-- OTHERWISE, ARISING FROM, OUT OF OR IN CONNECTION WITH THE SOFTWARE OR THE --
-- USE OR OTHER DEALINGS IN THE SOFTWARE. --
--
-- Except as contained in this notice, the name(s) of the above copyright --
-- holders shall not be used in advertising or otherwise to promote the --
-- sale, use or other dealings in this Software without prior written --
-- authorization. --
-----
-- $Id: AUTHORS,v 1.2 2006/10/28 21:44:52 tom Exp $ -----
----- These are the principal
authors/contributors of ncurses since 1.9.9e, in decreasing order of their
contribution:
```

TD Thomas E. Dickey JPFJuergen Pfeifer ESREric S Raymond AVLAlexander V
Lukyanov PBPhilippe Blain SVSven Verdoolaege

net-snmp 5.7.2

Various copyrights apply to this package, listed in various separate parts below.
Please make sure that you read all the parts.

---- Part 1: CMU/UCD copyright notice: (BSD like) ----

Copyright 1989, 1991, 1992 by Carnegie Mellon University

Derivative Work - 1996, 1998-2000 Copyright 1996, 1998-2000 The Regents of the
University of California
All Rights Reserved

Permission to use, copy, modify and distribute this software and its documentation for any purpose and without fee is hereby granted, provided that the above copyright notice appears in all copies and that both that copyright notice and this permission notice appear in supporting documentation, and that the name of CMU and The Regents of the University of California not be used in advertising or publicity pertaining to distribution of the software without specific written permission.

CMU AND THE REGENTS OF THE UNIVERSITY OF CALIFORNIA DISCLAIM ALL WARRANTIES WITH REGARD TO THIS SOFTWARE, INCLUDING ALL IMPLIED WARRANTIES OF MERCHANTABILITY AND FITNESS. IN NO EVENT SHALL CMU OR THE REGENTS OF THE UNIVERSITY OF CALIFORNIA BE LIABLE FOR ANY SPECIAL, INDIRECT OR CONSEQUENTIAL DAMAGES OR ANY DAMAGES WHATSOEVER RESULTING FROM THE LOSS OF USE, DATA OR PROFITS, WHETHER IN AN ACTION OF CONTRACT, NEGLIGENCE OR OTHER TORTIOUS ACTION, ARISING OUT OF OR IN CONNECTION WITH THE USE OR PERFORMANCE OF THIS SOFTWARE.

---- Part 2: Networks Associates Technology, Inc copyright notice (BSD) ----

Copyright (c) 2001-2003, Networks Associates Technology, Inc All rights reserved. Redistribution and use in source and binary forms, with or without modification, are permitted provided that the following conditions are met: * Redistributions of source code must retain the above copyright notice, this list of conditions and the following disclaimer. * Redistributions in binary form must reproduce the above copyright notice, this list of conditions and the following disclaimer in the documentation and/or other materials provided with the distribution. * Neither the name of the Networks Associates Technology, Inc nor the names of its contributors may be used to endorse or promote products derived from this software without specific prior written permission. THIS SOFTWARE IS PROVIDED BY THE COPYRIGHT HOLDERS AND CONTRIBUTORS ``AS IS'' AND ANY EXPRESS OR IMPLIED WARRANTIES, INCLUDING, BUT NOT LIMITED TO, THE IMPLIED WARRANTIES OF MERCHANTABILITY AND FITNESS FOR A PARTICULAR PURPOSE ARE DISCLAIMED. IN NO EVENT SHALL THE COPYRIGHT HOLDERS OR CONTRIBUTORS BE LIABLE FOR ANY DIRECT, INDIRECT, INCIDENTAL, SPECIAL, EXEMPLARY, OR CONSEQUENTIAL DAMAGES (INCLUDING, BUT NOT LIMITED TO, PROCUREMENT OF SUBSTITUTE GOODS OR SERVICES; LOSS OF USE, DATA, OR PROFITS; OR BUSINESS INTERRUPTION) HOWEVER CAUSED AND ON ANY THEORY OF LIABILITY, WHETHER IN CONTRACT, STRICT LIABILITY, OR TORT (INCLUDING NEGLIGENCE OR OTHERWISE) ARISING IN ANY WAY OUT OF THE USE OF THIS SOFTWARE, EVEN IF ADVISED OF THE POSSIBILITY OF SUCH DAMAGE.

---- Part 3: Cambridge Broadband Ltd. copyright notice (BSD) ----

Portions of this code are copyright (c) 2001-2003, Cambridge Broadband Ltd. All rights reserved. Redistribution and use in source and binary forms, with or without modification, are permitted provided that the following conditions are met: * Redistributions of source code must retain the above copyright notice, this list of conditions and the following disclaimer. * Redistributions in binary form must reproduce the above copyright notice, this list of conditions and the following disclaimer in the documentation and/or other materials provided with the distribution. * The name of Cambridge Broadband Ltd. may not be used to endorse or promote products derived from this software without specific prior written permission. THIS SOFTWARE IS PROVIDED BY THE COPYRIGHT HOLDER ``AS IS'' AND ANY EXPRESS OR IMPLIED WARRANTIES, INCLUDING, BUT NOT LIMITED TO, THE IMPLIED WARRANTIES OF MERCHANTABILITY AND FITNESS FOR A PARTICULAR PURPOSE ARE DISCLAIMED. IN NO EVENT SHALL THE COPYRIGHT HOLDER BE LIABLE FOR ANY DIRECT, INDIRECT, INCIDENTAL, SPECIAL, EXEMPLARY, OR CONSEQUENTIAL DAMAGES (INCLUDING, BUT NOT LIMITED TO, PROCUREMENT OF SUBSTITUTE GOODS OR SERVICES; LOSS OF USE, DATA, OR PROFITS; OR BUSINESS INTERRUPTION) HOWEVER CAUSED AND ON ANY THEORY OF LIABILITY, WHETHER IN CONTRACT, STRICT LIABILITY, OR TORT (INCLUDING NEGLIGENCE OR OTHERWISE) ARISING IN ANY WAY OUT OF THE USE OF THIS SOFTWARE, EVEN IF ADVISED OF THE POSSIBILITY OF SUCH DAMAGE.

---- Part 4: Sun Microsystems, Inc. copyright notice (BSD) ----

Copyright 2003 Sun Microsystems, Inc., 4150 Network Circle, Santa Clara, California 95054, U.S.A. All rights reserved.

Use is subject to license terms below.

This distribution may include materials developed by third parties.

Sun, Sun Microsystems, the Sun logo and Solaris are trademarks or registered trademarks of Sun Microsystems, Inc. in the U.S. and other countries.

Redistribution and use in source and binary forms, with or without modification, are permitted provided that the following conditions are met:

* Redistributions of source code must retain the above copyright notice, this list of conditions and the following disclaimer.

* Redistributions in binary form must reproduce the above copyright notice, this list of conditions and the following disclaimer in the documentation and/or other materials provided with the distribution.

* Neither the name of the Sun Microsystems, Inc. nor the names of its contributors may be used to endorse or promote products derived from this software without specific prior written permission.

THIS SOFTWARE IS PROVIDED BY THE COPYRIGHT HOLDERS AND CONTRIBUTORS ``AS IS'' AND ANY EXPRESS OR IMPLIED WARRANTIES, INCLUDING, BUT NOT LIMITED TO, THE IMPLIED WARRANTIES OF MERCHANTABILITY AND FITNESS FOR A PARTICULAR PURPOSE ARE DISCLAIMED. IN NO EVENT SHALL THE COPYRIGHT HOLDERS OR CONTRIBUTORS BE LIABLE FOR ANY DIRECT, INDIRECT, INCIDENTAL, SPECIAL, EXEMPLARY, OR CONSEQUENTIAL DAMAGES (INCLUDING, BUT NOT LIMITED TO, PROCUREMENT OF SUBSTITUTE GOODS OR SERVICES; LOSS OF USE, DATA, OR PROFITS; OR BUSINESS INTERRUPTION) HOWEVER CAUSED AND ON ANY THEORY OF LIABILITY, WHETHER IN CONTRACT, STRICT LIABILITY, OR TORT (INCLUDING NEGLIGENCE OR OTHERWISE) ARISING IN ANY WAY OUT OF THE USE OF THIS SOFTWARE, EVEN IF ADVISED OF THE POSSIBILITY OF SUCH DAMAGE.

---- Part 5: Sparta, Inc copyright notice (BSD) ----

Copyright (c) 2003-2012, Sparta, Inc All rights reserved. Redistribution and use in source and binary forms, with or without modification, are permitted provided that the following conditions are met: * Redistributions of source code must retain the above copyright notice, this list of conditions and the following disclaimer. * Redistributions in binary form must reproduce the above copyright notice, this list of conditions and the following disclaimer in the documentation and/or other materials provided with the distribution. * Neither the name of Sparta, Inc nor the names of its contributors may be used to endorse or promote products derived from this software without specific prior written permission. THIS SOFTWARE IS PROVIDED BY THE COPYRIGHT HOLDERS AND CONTRIBUTORS ``AS IS'' AND ANY EXPRESS OR IMPLIED WARRANTIES, INCLUDING, BUT NOT LIMITED TO, THE IMPLIED WARRANTIES OF MERCHANTABILITY AND FITNESS FOR A PARTICULAR PURPOSE ARE DISCLAIMED. IN NO EVENT SHALL THE COPYRIGHT HOLDERS OR CONTRIBUTORS BE LIABLE FOR ANY DIRECT, INDIRECT, INCIDENTAL, SPECIAL, EXEMPLARY, OR CONSEQUENTIAL DAMAGES (INCLUDING, BUT NOT LIMITED TO, PROCUREMENT OF SUBSTITUTE GOODS OR SERVICES; LOSS OF USE, DATA, OR PROFITS; OR BUSINESS INTERRUPTION) HOWEVER CAUSED AND ON ANY THEORY OF LIABILITY, WHETHER IN CONTRACT, STRICT LIABILITY, OR TORT (INCLUDING NEGLIGENCE OR OTHERWISE) ARISING IN ANY WAY OUT OF THE USE OF THIS SOFTWARE, EVEN IF ADVISED OF THE POSSIBILITY OF SUCH DAMAGE.

---- Part 6: Cisco/BUPTNIC copyright notice (BSD) ----

Copyright (c) 2004, Cisco, Inc and Information Network Center of Beijing University of Posts and Telecommunications. All rights reserved. Redistribution and use in source and binary forms, with or without modification, are permitted provided that the following conditions are met: * Redistributions of source code must retain the above copyright notice, this list of conditions and the following disclaimer. * Redistributions in binary form must reproduce the above copyright notice, this list of conditions and the following disclaimer in the documentation and/or other materials provided with the distribution. * Neither the name of Cisco, Inc, Beijing University of Posts and Telecommunications, nor the names of their contributors may be used to endorse or promote products derived from this software without specific prior written permission. THIS SOFTWARE IS PROVIDED BY THE COPYRIGHT HOLDERS AND CONTRIBUTORS ``AS IS'' AND ANY EXPRESS OR IMPLIED WARRANTIES, INCLUDING, BUT NOT LIMITED TO, THE IMPLIED WARRANTIES OF MERCHANTABILITY AND FITNESS FOR A PARTICULAR PURPOSE ARE DISCLAIMED. IN NO EVENT SHALL THE COPYRIGHT HOLDERS OR CONTRIBUTORS BE LIABLE FOR ANY DIRECT, INDIRECT, INCIDENTAL, SPECIAL, EXEMPLARY, OR CONSEQUENTIAL DAMAGES (INCLUDING, BUT NOT LIMITED TO, PROCUREMENT OF SUBSTITUTE GOODS OR SERVICES; LOSS OF USE, DATA, OR PROFITS; OR BUSINESS INTERRUPTION) HOWEVER CAUSED AND ON ANY THEORY OF LIABILITY, WHETHER IN CONTRACT, STRICT LIABILITY, OR TORT (INCLUDING NEGLIGENCE OR OTHERWISE) ARISING IN ANY WAY OUT OF THE USE OF THIS SOFTWARE, EVEN IF ADVISED OF THE POSSIBILITY OF SUCH DAMAGE.

---- Part 7: Fabasoft R&D Software GmbH & Co KG copyright notice (BSD) ----

Copyright (c) Fabasoft R&D Software GmbH & Co KG, 2003 oss@fabasoft.com Author: Bernhard Penz <bernhard.penz@fabasoft.com>

Redistribution and use in source and binary forms, with or without modification, are permitted provided that the following conditions are met:

- * Redistributions of source code must retain the above copyright notice, this list of conditions and the following disclaimer.
- * Redistributions in binary form must reproduce the above copyright notice, this list of conditions and the following disclaimer in the documentation and/or other materials provided with the distribution.
- * The name of Fabasoft R&D Software GmbH & Co KG or any of its subsidiaries, brand or product names may not be used to endorse or promote products derived from this software without specific prior written permission.

THIS SOFTWARE IS PROVIDED BY THE COPYRIGHT HOLDER ``AS IS'' AND ANY EXPRESS OR IMPLIED WARRANTIES, INCLUDING, BUT NOT LIMITED TO, THE IMPLIED WARRANTIES OF MERCHANTABILITY AND FITNESS FOR A PARTICULAR PURPOSE ARE DISCLAIMED. IN NO EVENT SHALL THE COPYRIGHT HOLDER BE LIABLE FOR ANY DIRECT, INDIRECT, INCIDENTAL, SPECIAL, EXEMPLARY, OR CONSEQUENTIAL DAMAGES (INCLUDING, BUT NOT LIMITED TO, PROCUREMENT OF SUBSTITUTE GOODS OR SERVICES; LOSS OF USE, DATA, OR PROFITS; OR BUSINESS INTERRUPTION) HOWEVER CAUSED AND ON ANY THEORY OF LIABILITY, WHETHER IN CONTRACT, STRICT LIABILITY, OR TORT (INCLUDING NEGLIGENCE OR OTHERWISE) ARISING IN ANY WAY OUT OF THE USE OF THIS SOFTWARE, EVEN IF ADVISED OF THE POSSIBILITY OF SUCH DAMAGE.

---- Part 8: Apple Inc. copyright notice (BSD) ----

Copyright (c) 2007 Apple Inc. All rights reserved.

Redistribution and use in source and binary forms, with or without modification, are permitted provided that the following conditions are met:

1. Redistributions of source code must retain the above copyright notice, this list of conditions and the following disclaimer.
2. Redistributions in binary form must reproduce the above copyright notice, this list of conditions and the following disclaimer in the documentation and/or other materials provided with the distribution.
3. Neither the name of Apple Inc. ("Apple") nor the names of its contributors may be used to endorse or promote products derived from this software without specific prior written permission.

THIS SOFTWARE IS PROVIDED BY APPLE AND ITS CONTRIBUTORS "AS IS" AND ANY EXPRESS OR IMPLIED WARRANTIES, INCLUDING, BUT NOT LIMITED TO, THE IMPLIED WARRANTIES OF MERCHANTABILITY AND FITNESS FOR A PARTICULAR PURPOSE ARE DISCLAIMED. IN NO EVENT SHALL APPLE OR ITS CONTRIBUTORS BE LIABLE FOR ANY DIRECT, INDIRECT, INCIDENTAL, SPECIAL, EXEMPLARY, OR CONSEQUENTIAL DAMAGES (INCLUDING, BUT NOT LIMITED TO, PROCUREMENT OF SUBSTITUTE GOODS OR SERVICES; LOSS OF USE, DATA, OR PROFITS; OR BUSINESS INTERRUPTION) HOWEVER CAUSED AND ON ANY THEORY OF LIABILITY, WHETHER IN CONTRACT, STRICT LIABILITY, OR TORT (INCLUDING NEGLIGENCE OR OTHERWISE) ARISING IN ANY WAY OUT OF THE USE OF THIS SOFTWARE, EVEN IF ADVISED OF THE POSSIBILITY OF SUCH DAMAGE.

---- Part 9: ScienceLogic, LLC copyright notice (BSD) ----

Copyright (c) 2009, ScienceLogic, LLC All rights reserved. Redistribution and use in source and binary forms, with or without modification, are permitted provided that the following conditions are met:

- * Redistributions of source code must retain the above copyright notice, this list of conditions and the following disclaimer.
- * Redistributions in binary form must reproduce the above copyright notice, this list of conditions and the following disclaimer in the documentation and/or other materials provided with the distribution.
- * Neither the name of ScienceLogic, LLC nor the names of its contributors may be used to endorse or promote products derived from this software without specific prior

written permission. THIS SOFTWARE IS PROVIDED BY THE COPYRIGHT HOLDERS AND CONTRIBUTORS ``AS IS'' AND ANY EXPRESS OR IMPLIED WARRANTIES, INCLUDING, BUT NOT LIMITED TO, THE IMPLIED WARRANTIES OF MERCHANTABILITY AND FITNESS FOR A PARTICULAR PURPOSE ARE DISCLAIMED. IN NO EVENT SHALL THE COPYRIGHT HOLDERS OR CONTRIBUTORS BE LIABLE FOR ANY DIRECT, INDIRECT, INCIDENTAL, SPECIAL, EXEMPLARY, OR CONSEQUENTIAL DAMAGES (INCLUDING, BUT NOT LIMITED TO, PROCUREMENT OF SUBSTITUTE GOODS OR SERVICES; LOSS OF USE, DATA, OR PROFITS; OR BUSINESS INTERRUPTION) HOWEVER CAUSED AND ON ANY THEORY OF LIABILITY, WHETHER IN CONTRACT, STRICT LIABILITY, OR TORT (INCLUDING NEGLIGENCE OR OTHERWISE) ARISING IN ANY WAY OUT OF THE USE OF THIS SOFTWARE, EVEN IF ADVISED OF THE POSSIBILITY OF SUCH DAMAGE.

open-Ildap 0.9.46

"This software program is licensed subject to the GNU General Public License (GPL). Version 2, June 1991, available at <http://www.fsf.org/copyleft/gpl.html>"

GNU General Public License

Version 2, June 1991

Copyright (C) 1989, 1991 Free Software Foundation, Inc. 59 Temple Place - Suite 330, Boston, MA 02111-1307, USA

Everyone is permitted to copy and distribute verbatim copies of this license document, but changing it is not allowed.

Preamble

The licenses for most software are designed to take away your freedom to share and change it. By contrast, the GNU General Public License is intended to guarantee your freedom to share and change free software--to make sure the software is free for all its users. This General Public License applies to most of the Free Software Foundation's software and to any other program whose authors commit to using it. (Some other Free Software Foundation software is covered by the GNU Library General Public License instead.) You can apply it to your programs, too.

When we speak of free software, we are referring to freedom, not price. Our General Public Licenses are designed to make sure that you have the freedom to distribute copies of free software (and charge for this service if you wish), that you receive source code or can get it if you want it, that you can change the software or use pieces of it in new free programs; and that you know you can do these things.

To protect your rights, we need to make restrictions that forbid anyone to deny you these rights or to ask you to surrender the rights. These restrictions translate to certain responsibilities for you if you distribute copies of the software, or if you modify it.

For example, if you distribute copies of such a program, whether gratis or for a fee, you must give the recipients all the rights that you have. You must make sure that they, too, receive or can get the source code. And you must show them these terms so they know their rights. We protect your rights with two steps: (1) copyright the software, and (2) offer you this license which gives you legal permission to copy, distribute and/or modify the software.

Also, for each author's protection and ours, we want to make certain that everyone understands that there is no warranty for this free software. If the software is modified by someone else and passed on, we want its recipients to know that what they have is not the original, so that any problems introduced by others will not reflect on the original authors' reputations.

Finally, any free program is threatened constantly by software patents. We wish to avoid the danger that redistributors of a free program will individually obtain patent licenses, in effect making the program proprietary. To prevent this, we have made it clear that any patent must be licensed for everyone's free use or not licensed at all.

The precise terms and conditions for copying, distribution and modification follow.

TERMS AND CONDITIONS FOR COPYING, DISTRIBUTION AND MODIFICATION

0. This License applies to any program or other work which contains a notice placed by the copyright holder saying it may be distributed under the terms of this General Public License. The "Program", below, refers to any such program or work, and a "work based on the Program" means either the Program or any derivative work under copyright law: that is to say, a work containing the Program or a portion of it, either verbatim or with modifications and/or translated into another language. (Hereinafter, translation is included without limitation in the term "modification".) Each licensee is addressed as "you".

Activities other than copying, distribution and modification are not covered by this License; they are outside its scope. The act of running the Program is not restricted, and the output from the Program is covered only if its contents constitute a work based on the Program (independent of having been made by running the Program). Whether that is true depends on what the Program does.

1. You may copy and distribute verbatim copies of the Program's source code as you receive it, in any medium, provided that you conspicuously and appropriately publish on each copy an appropriate copyright notice and disclaimer of warranty; keep intact all the notices that refer to this License and to the absence of any warranty; and give any other recipients of the Program a copy of this License along with the Program.

You may charge a fee for the physical act of transferring a copy, and you may at your option offer warranty protection in exchange for a fee.

2. You may modify your copy or copies of the Program or any portion of it, thus forming a work based on the Program, and copy and distribute such modifications or work under the terms of Section 1 above, provided that you also meet all of these conditions:

* a) You must cause the modified files to carry prominent notices stating that you changed the files and the date of any change.

* b) You must cause any work that you distribute or publish, that in whole or in part contains or is derived from the Program or any part thereof, to be licensed as a whole at no charge to all third parties under the terms of this License.

* c) If the modified program normally reads commands interactively when run, you must cause it, when started running for such interactive use in the most ordinary way, to print or display an announcement including an appropriate copyright notice and a notice that there is no warranty (or else, saying that you provide a warranty) and that users may redistribute the program under these conditions, and telling the user how to view a copy of this License. (Exception: if the Program itself is interactive but does not normally print such an announcement, your work based on the Program is not required to print an announcement.)

These requirements apply to the modified work as a whole. If identifiable sections of that work are not derived from the Program, and can be reasonably considered independent and separate works in themselves, then this License, and its terms, do not apply to those sections when you distribute them as separate works. But when you distribute the same sections as part of a whole

which is a work based on the Program, the distribution of the whole must be on the terms of this License, whose permissions for other licensees extend to the entire whole, and thus to each and every part regardless of who wrote it.

Thus, it is not the intent of this section to claim rights or contest your rights to work written entirely by you; rather, the intent is to exercise the right to control the distribution of derivative or collective works based on the Program.

In addition, mere aggregation of another work not based on the Program with the Program (or with a work based on the Program) on a volume of a storage or distribution medium does not bring the other work under the scope of this License.

3. You may copy and distribute the Program (or a work based on it, under Section 2) in object code or executable form under the terms of Sections 1 and 2 above provided that you also do one of the following:

- * a) Accompany it with the complete corresponding machine-readable source code, which must be distributed under the terms of Sections 1 and 2 above on a medium customarily used for software interchange; or,

- * b) Accompany it with a written offer, valid for at least three years, to give any third party, for a charge no more than your cost of physically performing source distribution, a complete machine-readable copy of the corresponding source code, to be distributed under the terms of Sections 1 and 2 above on a medium customarily used for software interchange; or,

- * c) Accompany it with the information you received as to the offer to distribute corresponding source code. (This alternative is allowed only for noncommercial distribution and only if you received the program in object code or executable form with such an offer, in accord with Subsection b above.)

The source code for a work means the preferred form of the work for making modifications to it. For an executable work, complete source code means all the source code for all modules it contains, plus any associated interface definition files, plus the scripts used to control compilation and installation of the executable. However, as a special exception, the source code distributed need not include anything that is normally distributed (in either source or binary form) with the major components (compiler, kernel, and so on) of the operating system on which the executable runs, unless that component itself accompanies the executable.

If distribution of executable or object code is made by offering access to copy from a designated place, then offering equivalent access to copy the source code from the same place counts as distribution of the source code, even though third parties are not compelled to copy the source along with the object code.

4. You may not copy, modify, sublicense, or distribute the Program except as expressly provided under this License. Any attempt otherwise to copy, modify, sublicense or distribute the Program is void, and will automatically terminate your rights under this License. However, parties who have received copies, or rights, from you under this License will not have their licenses terminated so long as such parties remain in full compliance.

5. You are not required to accept this License, since you have not signed it. However, nothing else grants you permission to modify or distribute the Program or its derivative works. These actions are prohibited by law if you do not accept this License. Therefore, by modifying or distributing the Program (or any work based on the Program), you indicate your acceptance of this License to do so, and all its terms and conditions for copying, distributing or modifying the Program or works based on it.

6. Each time you redistribute the Program (or any work based on the Program), the recipient automatically receives a license from the original licensor to copy, distribute or modify the Program subject to these terms and conditions. You may not impose any further restrictions on the recipients' exercise of the rights granted herein. You are not responsible for enforcing compliance by third parties to this License.

7. If, as a consequence of a court judgment or allegation of patent infringement or for any other reason (not limited to patent issues), conditions are imposed on you (whether by court order, agreement or otherwise) that contradict the conditions of this License, they do not excuse you from the conditions of this License. If you cannot distribute so as to satisfy simultaneously your obligations under this License and any other pertinent obligations, then as a consequence you may not distribute the Program at all. For example, if a patent license would not permit royalty-free redistribution of the Program by all those who receive copies directly or indirectly through you, then the only way you could satisfy both it and this License would be to refrain entirely from distribution of the Program.

If any portion of this section is held invalid or unenforceable under any particular circumstance, the balance of the section is intended to apply and the section as a whole is intended to apply in other circumstances.

It is not the purpose of this section to induce you to infringe any patents or other property right claims or to contest validity of any such claims; this section has the sole purpose of protecting the integrity of the free software distribution system, which is implemented by public license practices. Many people have made generous contributions to the wide range of software distributed through that system in reliance on consistent application of that system; it is up to the author/donor to decide if he or she is willing to distribute software through any other system and a licensee cannot impose that choice.

This section is intended to make thoroughly clear what is believed to be a consequence of the rest of this License.

8. If the distribution and/or use of the Program is restricted in certain countries either by patents or by copyrighted interfaces, the original copyright holder who places the Program under this License may add an explicit geographical distribution limitation excluding those countries, so that distribution is permitted only in or among countries not thus excluded. In such case, this License incorporates the limitation as if written in the body of this License.

9. The Free Software Foundation may publish revised and/or new versions of the General Public License from time to time. Such new versions will be similar in spirit to the present version, but may differ in detail to address new problems or concerns.

Each version is given a distinguishing version number. If the Program specifies a version number of this License which applies to it and "any later version", you have the option of following the terms and conditions either of that version or of any later version published by the Free Software Foundation. If the Program does not specify a version number of this License, you may choose any version ever published by the Free Software Foundation.

10. If you wish to incorporate parts of the Program into other free programs whose distribution conditions are different, write to the author to ask for permission. For software which is copyrighted by the Free Software Foundation, write to the Free Software Foundation; we sometimes make exceptions for this. Our decision will be guided by the two goals of preserving the free status of all derivatives of our free software and of promoting the sharing and reuse of software generally.

NO WARRANTY

11. BECAUSE THE PROGRAM IS LICENSED FREE OF CHARGE, THERE IS NO WARRANTY FOR THE PROGRAM, TO THE EXTENT PERMITTED BY APPLICABLE LAW. EXCEPT WHEN OTHERWISE STATED IN WRITING THE COPYRIGHT HOLDERS AND/OR OTHER PARTIES PROVIDE THE PROGRAM "AS IS" WITHOUT WARRANTY OF ANY KIND, EITHER EXPRESSED OR IMPLIED, INCLUDING, BUT NOT LIMITED TO, THE IMPLIED WARRANTIES OF MERCHANTABILITY AND FITNESS FOR A PARTICULAR PURPOSE. THE ENTIRE RISK AS TO THE QUALITY AND PERFORMANCE OF THE PROGRAM IS WITH YOU. SHOULD THE PROGRAM PROVE DEFECTIVE, YOU ASSUME THE COST OF ALL NECESSARY SERVICING, REPAIR OR CORRECTION.

12. IN NO EVENT UNLESS REQUIRED BY APPLICABLE LAW OR AGREED TO IN WRITING WILL ANY COPYRIGHT HOLDER, OR ANY OTHER PARTY WHO MAY MODIFY AND/OR REDISTRIBUTE THE PROGRAM AS PERMITTED ABOVE, BE LIABLE TO YOU FOR DAMAGES, INCLUDING ANY GENERAL, SPECIAL, INCIDENTAL OR CONSEQUENTIAL DAMAGES ARISING OUT OF THE USE OR INABILITY TO USE THE PROGRAM (INCLUDING BUT NOT LIMITED TO LOSS OF DATA OR DATA BEING RENDERED INACCURATE OR LOSSES SUSTAINED BY YOU OR THIRD PARTIES OR A FAILURE OF THE PROGRAM TO OPERATE WITH ANY OTHER PROGRAMS), EVEN IF SUCH HOLDER OR OTHER PARTY HAS BEEN ADVISED OF THE POSSIBILITY OF SUCH DAMAGES.

END OF TERMS AND CONDITIONS

How to Apply These Terms to Your New Programs

If you develop a new program, and you want it to be of the greatest possible use to the public, the best way to achieve this is to make it free software which everyone can redistribute and change under these terms.

To do so, attach the following notices to the program. It is safest to attach them to the start of each source file to most effectively convey the exclusion of warranty; and each file should have at least the "copyright" line and a pointer to where the full notice is found.

one line to give the program's name and an idea of what it does. Copyright (C) yyyy name of author

This program is free software; you can redistribute it and/or modify it under the terms of the GNU General Public License as published by the Free Software Foundation; either version 2 of the License, or (at your option) any later version.

This program is distributed in the hope that it will be useful, but WITHOUT ANY WARRANTY; without even the implied warranty of MERCHANTABILITY or FITNESS FOR A PARTICULAR PURPOSE. See the GNU General Public License for more details.

You should have received a copy of the GNU General Public License along with this program; if not, write to the Free Software Foundation, Inc., 59 Temple Place - Suite 330, Boston, MA 02111-1307, USA.

Also add information on how to contact you by electronic and paper mail.

If the program is interactive, make it output a short notice like this when it starts in an interactive mode:

Gnomovision version 69, Copyright (C) year name of author Gnomovision comes with ABSOLUTELY NO WARRANTY; for details type 'show w'. This is free software, and you are welcome to redistribute it under certain conditions; type 'show c' for details.

The hypothetical commands 'show w' and 'show c' should show the appropriate parts of the General Public License. Of course, the commands you use may be called something other than 'show w' and 'show c'; they could even be mouse-clicks or menu items--whatever suits your program.

You should also get your employer (if you work as a programmer) or your school, if any, to sign a "copyright disclaimer" for the program, if necessary. Here is a sample; alter the names:

Yoyodyne, Inc., hereby disclaims all copyright interest in the program 'Gnomovision' (which makes passes at compilers) written by James Hacker.

signature of Ty Coon, 1 April 1989 Ty Coon, President of Vice

This General Public License does not permit incorporating your program into proprietary programs. If your program is a subroutine library, you may consider it more useful to permit linking proprietary applications with the library. If this is what you want to do, use the GNU Library General Public License instead of this License.

openssl 1.0.1j

LICENSE ISSUES =====

The OpenSSL toolkit stays under a dual license, i.e. both the conditions of the OpenSSL license and the original SSLeay license apply to the toolkit. See below for the actual license texts. Actually both licenses are BSD-style Open Source licenses. In case of any license issues related to OpenSSL please contact openssl-core@openssl.org.

OpenSSL License -----

```

/* =====
Copyright (c) 1998-2011 The OpenSSL Project. All rights reserved.
Redistribution and use in source and binary forms, with or without
modification, are permitted provided that the following conditions
are met:
1. Redistributions of source code must retain the above copyright
notice, this list of conditions and the following disclaimer.
2. Redistributions in binary form must reproduce the above copyright
notice, this list of conditions and the following disclaimer in
the documentation and/or other materials provided with the
distribution.
3. All advertising materials mentioning features or use of this
software must display the following acknowledgment:
"This product includes software developed by the OpenSSL
Project for use in the OpenSSL Toolkit. (http://www.openssl.org/)"
4. The names "OpenSSL Toolkit" and "OpenSSL Project" must not be used
to endorse or promote products derived from this software without
prior written permission. For written permission, please contact
openssl-core@openssl.org.
5. Products derived from this software may not be called "OpenSSL"
nor may "OpenSSL" appear in their names without prior written
permission of the OpenSSL Project.
6. Redistributions of any form whatsoever must retain the
following acknowledgment:
"This product includes software developed
by the OpenSSL Project for use in the OpenSSL Toolkit
(http://www.openssl.org/)"
THIS SOFTWARE IS PROVIDED BY THE OpenSSL PROJECT
AS IS AND ANY EXPRESSED OR IMPLIED WARRANTIES, INCLUDING,
BUT NOT LIMITED TO, THE IMPLIED WARRANTIES OF MERCHANTABILITY
AND FITNESS FOR A PARTICULAR PURPOSE ARE DISCLAIMED.
IN NO EVENT SHALL THE OpenSSL PROJECT OR ITS CONTRIBUTORS
BE LIABLE FOR ANY DIRECT, INDIRECT, INCIDENTAL, SPECIAL,
EXEMPLARY, OR CONSEQUENTIAL DAMAGES (INCLUDING, BUT NOT LIMITED
TO, PROCUREMENT OF SUBSTITUTE GOODS OR SERVICES; LOSS OF USE,
DATA, OR PROFITS; OR BUSINESS INTERRUPTION) HOWEVER CAUSED
AND ON ANY THEORY OF LIABILITY, WHETHER IN CONTRACT, STRICT
LIABILITY, OR TORT (INCLUDING NEGLIGENCE OR OTHERWISE) ARISING
IN ANY WAY OUT OF THE USE OF THIS SOFTWARE, EVEN IF ADVISED
OF THE POSSIBILITY OF SUCH DAMAGE.
=====
This product includes cryptographic software written by Eric Young
(eay@cryptsoft.com). This product includes software written by Tim
Hudson (tjh@cryptsoft.com).

```

Original SSLeay License -----

```

/* Copyright (C) 1995-1998 Eric Young (eay@cryptsoft.com)
All rights reserved.
This package is an SSL implementation by Eric Young
(eay@cryptsoft.com). The implementation was written so as to conform
with Netscapes SSL. This library is free for commercial and non-commercial
use as long as the following conditions are adhered to. The following conditions

```

```

* apply to all code found in this distribution, be it the RC4, RSA, * lhash, DES,
etc., code; not just the SSL code. The SSL documentation * included with this
distribution is covered by the same copyright terms * except that the holder is
Tim Hudson (tjh@cryptsoft.com). * * Copyright remains Eric Young's, and as such
any Copyright notices in * the code are not to be removed. * If this package is
used in a product, Eric Young should be given attribution * as the author of the
parts of the library used. * This can be in the form of a textual message at
program startup or * in documentation (online or textual) provided with the
package. * * Redistribution and use in source and binary forms, with or without
* modification, are permitted provided that the following conditions * are met:
* 1. Redistributions of source code must retain the copyright * notice, this
list of conditions and the following disclaimer. * 2. Redistributions in binary
form must reproduce the above copyright * notice, this list of conditions and
the following disclaimer in the * documentation and/or other materials provided
with the distribution. * 3. All advertising materials mentioning features or use
of this software * must display the following acknowledgement: * "This
product includes cryptographic software written by * Eric Young
(eay@cryptsoft.com)" * The word 'cryptographic' can be left out if the rouines
from the library * being used are not cryptographic related :-). * 4. If you
include any Windows specific code (or a derivative thereof) from * the apps
directory (application code) you must include an acknowledgement: * "This
product includes software written by Tim Hudson (tjh@cryptsoft.com)" * * THIS
SOFTWARE IS PROVIDED BY ERIC YOUNG ``AS IS'' AND * ANY EXPRESS OR IMPLIED
WARRANTIES, INCLUDING, BUT NOT LIMITED TO, THE * IMPLIED WARRANTIES OF
MERCHANTABILITY AND FITNESS FOR A PARTICULAR PURPOSE * ARE DISCLAIMED. IN NO
EVENT SHALL THE AUTHOR OR CONTRIBUTORS BE LIABLE * FOR ANY DIRECT, INDIRECT,
INCIDENTAL, SPECIAL, EXEMPLARY, OR CONSEQUENTIAL * DAMAGES (INCLUDING, BUT NOT
LIMITED TO, PROCUREMENT OF SUBSTITUTE GOODS * OR SERVICES; LOSS OF USE, DATA, OR
PROFITS; OR BUSINESS INTERRUPTION) * HOWEVER CAUSED AND ON ANY THEORY OF
LIABILITY, WHETHER IN CONTRACT, STRICT * LIABILITY, OR TORT (INCLUDING NEGLIGENCE
OR OTHERWISE) ARISING IN ANY WAY * OUT OF THE USE OF THIS SOFTWARE, EVEN IF
ADVISED OF THE POSSIBILITY OF * SUCH DAMAGE. * * The licence and distribution
terms for any publically available version or * derivative of this code cannot
be changed. i.e. this code cannot simply be * copied and put under another
distribution licence * [including the GNU Public Licence.] */

```

sprintf.js 0.0.7

Copyright (c) 2007-2013, Alexandru Marasteanu <hello [at] alexei [dot] ro> All rights reserved.

Redistribution and use in source and binary forms, with or without modification, are permitted provided that the following conditions are met: * Redistributions of source code must retain the above copyright notice, this list of conditions and the following disclaimer. * Redistributions in binary form must reproduce the above copyright notice, this list of conditions and the following disclaimer in the documentation and/or other materials provided with the distribution. * Neither the name of this software nor the names of its contributors may be used to endorse or promote products derived from this software without specific prior written permission.

THIS SOFTWARE IS PROVIDED BY THE COPYRIGHT HOLDERS AND CONTRIBUTORS "AS IS" AND ANY EXPRESS OR IMPLIED WARRANTIES, INCLUDING, BUT NOT LIMITED TO, THE IMPLIED WARRANTIES OF MERCHANTABILITY AND FITNESS FOR A PARTICULAR PURPOSE ARE DISCLAIMED. IN NO EVENT SHALL THE AUTHORS OR COPYRIGHT HOLDERS BE LIABLE FOR ANY DIRECT, INDIRECT, INCIDENTAL, SPECIAL, EXEMPLARY, OR CONSEQUENTIAL DAMAGES (INCLUDING, BUT NOT LIMITED TO, PROCUREMENT OF SUBSTITUTE GOODS OR SERVICES; LOSS OF USE, DATA, OR PROFITS; OR BUSINESS INTERRUPTION) HOWEVER CAUSED AND ON ANY THEORY OF LIABILITY, WHETHER IN CONTRACT, STRICT LIABILITY, OR TORT (INCLUDING NEGLIGENCE OR OTHERWISE) ARISING IN ANY WAY OUT OF THE USE OF THIS SOFTWARE, EVEN IF ADVISED OF THE POSSIBILITY OF SUCH DAMAGE.

stp-engineGNU GENERAL PUBLIC LICENSE
Version 2, June 1991

Copyright (C) 1989, 1991 Free Software Foundation, Inc. 51 Franklin St, Fifth Floor, Boston, MA 02110-1301 USA Everyone is permitted to copy and distribute verbatim copies of this license document, but changing it is not allowed.

Preamble

The licenses for most software are designed to take away your freedom to share and change it. By contrast, the GNU General Public License is intended to guarantee your freedom to share and change free software--to make sure the software is free for all its users. This General Public License applies to most of the Free Software Foundation's software and to any other program whose authors commit to using it. (Some other Free Software Foundation software is covered by the GNU Library General Public License instead.) You can apply it to your programs, too.

When we speak of free software, we are referring to freedom, not price. Our General Public Licenses are designed to make sure that you have the freedom to distribute copies of free software (and charge for this service if you wish), that you receive source code or can get it if you want it, that you can change the software or use pieces of it in new free programs; and that you know you can do these things.

To protect your rights, we need to make restrictions that forbid anyone to deny you these rights or to ask you to surrender the rights. These restrictions translate to certain responsibilities for you if you distribute copies of the software, or if you modify it.

For example, if you distribute copies of such a program, whether gratis or for a fee, you must give the recipients all the rights that you have. You must make sure that they, too, receive or can get the source code. And you must show them these terms so they know their rights.

We protect your rights with two steps: (1) copyright the software, and (2) offer you this license which gives you legal permission to copy, distribute and/or modify the software.

Also, for each author's protection and ours, we want to make certain that everyone understands that there is no warranty for this free software. If the software is modified by someone else and passed on, we want its recipients to know that what they have is not the original, so that any problems introduced by others will not reflect on the original authors' reputations.

Finally, any free program is threatened constantly by software patents. We wish to avoid the danger that redistributors of a free program will individually obtain patent licenses, in effect making the program proprietary. To prevent this, we have made it clear that any patent must be licensed for everyone's free use or not licensed at all.

The precise terms and conditions for copying, distribution and modification follow.

GNU GENERAL PUBLIC LICENSE
TERMS AND CONDITIONS FOR COPYING, DISTRIBUTION AND MODIFICATION

0. This License applies to any program or other work which contains a notice placed by the copyright holder saying it may be distributed under the terms of this General Public License. The "Program", below, refers to any such program or work, and a "work based on the Program" means either the Program or any derivative work under copyright law: that is to say, a work containing the Program or a portion of it, either verbatim or with modifications and/or translated into another language. (Hereinafter, translation is included without limitation in the term "modification".) Each licensee is addressed as "you".

Activities other than copying, distribution and modification are not covered by this License; they are outside its scope. The act of running the Program is not restricted, and the output from the Program is covered only if its contents constitute a work based on the Program (independent of having been made by running the Program). Whether that is true depends on what the Program does.

1. You may copy and distribute verbatim copies of the Program's source code as you receive it, in any medium, provided that you conspicuously and appropriately publish on each copy an appropriate copyright notice and disclaimer of warranty; keep intact all the notices that refer to this License and to the absence of any warranty; and give any other recipients of the Program a copy of this License along with the Program.

You may charge a fee for the physical act of transferring a copy, and you may at your option offer warranty protection in exchange for a fee.

2. You may modify your copy or copies of the Program or any portion of it, thus forming a work based on the Program, and copy and distribute such modifications or work under the terms of Section 1 above, provided that you also meet all of these conditions:

a) You must cause the modified files to carry prominent notices stating that you changed the files and the date of any change.

b) You must cause any work that you distribute or publish, that in whole or in part contains or is derived from the Program or any part thereof, to be licensed as a whole at no charge to all third parties under the terms of this License.

c) If the modified program normally reads commands interactively when run, you must cause it, when started running for such interactive use in the most ordinary way, to print or display an announcement including an appropriate copyright notice and a notice that there is no warranty (or else, saying that you provide a warranty) and that users may redistribute the program under these conditions, and telling the user how to view a copy of this License. (Exception: if the Program itself is interactive but does not normally print such an announcement, your work based on the Program is not required to print an announcement.)

These requirements apply to the modified work as a whole. If identifiable sections of that work are not derived from the Program, and can be reasonably considered independent and separate works in themselves, then this License, and its terms, do not apply to those sections when you distribute them as separate works. But when you distribute the same sections as part of a whole which is a work based on the Program, the distribution of the whole must be on the terms of this License, whose permissions for other licensees extend to the entire whole, and thus to each and every part regardless of who wrote it.

Thus, it is not the intent of this section to claim rights or contest your rights to work written entirely by you; rather, the intent is to exercise the right to control the distribution of derivative or collective works based on the Program.

In addition, mere aggregation of another work not based on the Program with the Program (or with a work based on the Program) on a volume of a storage or distribution medium does not bring the other work under the scope of this License.

3. You may copy and distribute the Program (or a work based on it, under Section 2) in object code or executable form under the terms of Sections 1 and 2 above provided that you also do one of the following:

a) Accompany it with the complete corresponding machine-readable source code, which must be distributed under the terms of Sections 1 and 2 above on a medium customarily used for software interchange; or,

b) Accompany it with a written offer, valid for at least three years, to give any third party, for a charge no more than your cost of physically performing source distribution, a complete machine-readable copy of the corresponding source code, to be distributed under the terms of Sections 1 and 2 above on a medium customarily used for software interchange; or,

c) Accompany it with the information you received as to the offer to distribute corresponding source code. (This alternative is allowed only for noncommercial distribution and only if you received the program in object code or executable form with such an offer, in accord with Subsection b above.)

The source code for a work means the preferred form of the work for making modifications to it. For an executable work, complete source code means all the source code for all modules it contains, plus any associated interface definition files, plus the scripts used to control compilation and installation of the executable. However, as a special exception, the source code distributed need not include anything that is normally distributed (in either source or binary form) with the major components (compiler, kernel, and so on) of the operating system on which the executable runs, unless that component itself accompanies the executable.

If distribution of executable or object code is made by offering access to copy from a designated place, then offering equivalent access to copy the source code from the same place counts as distribution of the source code, even though third parties are not compelled to copy the source along with the object code.

4. You may not copy, modify, sublicense, or distribute the Program except as expressly provided under this License. Any attempt otherwise to copy, modify, sublicense or distribute the Program is void, and will automatically terminate your rights under this License. However, parties who have received copies, or rights, from you under this License will not have their licenses terminated so long as such parties remain in full compliance.

5. You are not required to accept this License, since you have not signed it. However, nothing else grants you permission to modify or distribute the Program or its derivative works. These actions are prohibited by law if you do not accept this License. Therefore, by modifying or distributing the Program (or any work based on the Program), you indicate your acceptance of this License to do so, and all its terms and conditions for copying, distributing or modifying the Program or works based on it.

6. Each time you redistribute the Program (or any work based on the Program), the recipient automatically receives a license from the original licensor to copy, distribute or modify the Program subject to these terms and conditions. You may not impose any further restrictions on the recipients' exercise of the rights granted herein. You are not responsible for enforcing compliance by third parties to this License.

7. If, as a consequence of a court judgment or allegation of patent infringement or for any other reason (not limited to patent issues), conditions are imposed on you (whether by court order, agreement or otherwise) that contradict the conditions of this License, they do not excuse you from the conditions of this License. If you cannot distribute so as to satisfy simultaneously your obligations under this License and any other pertinent obligations, then as a consequence you may not distribute the Program at all. For example, if a patent license would not permit royalty-free redistribution of the Program by all those who receive copies directly or indirectly through you, then the only way you could satisfy both it and this License would be to refrain entirely from distribution of the Program.

If any portion of this section is held invalid or unenforceable under any particular circumstance, the balance of the section is intended to apply and the section as a whole is intended to apply in other circumstances.

It is not the purpose of this section to induce you to infringe any patents or other property right claims or to contest validity of any such claims; this section has the sole purpose of protecting the integrity of the free software distribution

system, which is implemented by public license practices. Many people have made generous contributions to the wide range of software distributed through that system in reliance on consistent application of that system; it is up to the author/donor to decide if he or she is willing to distribute software through any other system and a licensee cannot impose that choice.

This section is intended to make thoroughly clear what is believed to be a consequence of the rest of this License.

8. If the distribution and/or use of the Program is restricted in certain countries either by patents or by copyrighted interfaces, the original copyright holder who places the Program under this License may add an explicit geographical distribution limitation excluding those countries, so that distribution is permitted only in or among countries not thus excluded. In such case, this License incorporates the limitation as if written in the body of this License.

9. The Free Software Foundation may publish revised and/or new versions of the General Public License from time to time. Such new versions will be similar in spirit to the present version, but may differ in detail to address new problems or concerns.

Each version is given a distinguishing version number. If the Program specifies a version number of this License which applies to it and "any later version", you have the option of following the terms and conditions either of that version or of any later version published by the Free Software Foundation. If the Program does not specify a version number of this License, you may choose any version ever published by the Free Software Foundation.

10. If you wish to incorporate parts of the Program into other free programs whose distribution conditions are different, write to the author to ask for permission. For software which is copyrighted by the Free Software Foundation, write to the Free Software Foundation; we sometimes make exceptions for this. Our decision will be guided by the two goals of preserving the free status of all derivatives of our free software and of promoting the sharing and reuse of software generally.

NO WARRANTY

11. BECAUSE THE PROGRAM IS LICENSED FREE OF CHARGE, THERE IS NO WARRANTY FOR THE PROGRAM, TO THE EXTENT PERMITTED BY APPLICABLE LAW. EXCEPT WHEN OTHERWISE STATED IN WRITING THE COPYRIGHT HOLDERS AND/OR OTHER PARTIES PROVIDE THE PROGRAM "AS IS" WITHOUT WARRANTY OF ANY KIND, EITHER EXPRESSED OR IMPLIED, INCLUDING, BUT NOT LIMITED TO, THE IMPLIED WARRANTIES OF MERCHANTABILITY AND FITNESS FOR A PARTICULAR PURPOSE. THE ENTIRE RISK AS TO THE QUALITY AND PERFORMANCE OF THE PROGRAM IS WITH YOU. SHOULD THE PROGRAM PROVE DEFECTIVE, YOU ASSUME THE COST OF ALL NECESSARY SERVICING, REPAIR OR CORRECTION.

12. IN NO EVENT UNLESS REQUIRED BY APPLICABLE LAW OR AGREED TO IN WRITING WILL ANY COPYRIGHT HOLDER, OR ANY OTHER PARTY WHO MAY MODIFY AND/OR REDISTRIBUTE THE PROGRAM AS PERMITTED ABOVE, BE LIABLE TO YOU FOR DAMAGES, INCLUDING ANY GENERAL, SPECIAL, INCIDENTAL OR CONSEQUENTIAL DAMAGES ARISING OUT OF THE USE OR INABILITY TO USE THE PROGRAM (INCLUDING BUT NOT LIMITED TO LOSS OF DATA OR DATA BEING RENDERED INACCURATE OR LOSSES SUSTAINED BY YOU OR THIRD PARTIES OR A FAILURE OF THE PROGRAM TO OPERATE WITH ANY OTHER PROGRAMS), EVEN IF SUCH HOLDER OR OTHER PARTY HAS BEEN ADVISED OF THE POSSIBILITY OF SUCH DAMAGES.

END OF TERMS AND CONDITIONS

How to Apply These Terms to Your New Programs

If you develop a new program, and you want it to be of the greatest possible use to the public, the best way to achieve this is to make it free software which everyone can redistribute and change under these terms.

To do so, attach the following notices to the program. It is safest to attach them to the start of each source file to most effectively convey the exclusion of warranty; and each file should have at least the "copyright" line and a pointer to where the full notice is found.

```
<one line to give the program's name and a brief idea of what it does.>
Copyright (C) <year> <name of author>
```

```
This program is free software; you can redistribute it and/or modify it
under the terms of the GNU General Public License as published by the Free
Software Foundation; either version 2 of the License, or (at your option) any
later version.
```

```
This program is distributed in the hope that it will be useful, but WITHOUT
ANY WARRANTY; without even the implied warranty of MERCHANTABILITY or FITNESS
FOR A PARTICULAR PURPOSE. See the GNU General Public License for more details.
```

```
You should have received a copy of the GNU General Public License along
with this program; if not, write to the Free Software Foundation, Inc., 51
Franklin St, Fifth Floor, Boston, MA 02110-1301 USA
```

Also add information on how to contact you by electronic and paper mail.

If the program is interactive, make it output a short notice like this when it starts in an interactive mode:

```
Gnomovision version 69, Copyright (C) year name of author Gnomovision
comes with ABSOLUTELY NO WARRANTY; for details type `show w'. This is free
software, and you are welcome to redistribute it under certain conditions;
type `show c' for details.
```

The hypothetical commands `show w' and `show c' should show the appropriate parts of the General Public License. Of course, the commands you use may be called something other than `show w' and `show c'; they could even be mouse-clicks or menu items--whatever suits your program.

You should also get your employer (if you work as a programmer) or your school, if any, to sign a "copyright disclaimer" for the program, if necessary. Here is a sample; alter the names:

```
Yoyodyne, Inc., hereby disclaims all copyright interest in the program
`Gnomovision' (which makes passes at compilers) written by James Hacker.
```

```
<signature of Ty Coon>, 1 April 1989 Ty Coon, President of Vice
```

This General Public License does not permit incorporating your program into proprietary programs. If your program is a subroutine library, you may consider it more useful to permit linking proprietary applications with the library. If this is what you want to do, use the GNU Library General Public License instead of this License.

tinytest 06d58ad0945607c0a57364bc0258620191839c0f

```
GNU LIBRARY GENERAL PUBLIC LICENSE Version 2, June 1991
```

```
Copyright (C) 1991 Free Software Foundation, Inc. 51 Franklin Street, Fifth
Floor, Boston, MA 02110-1301, USA Everyone is permitted to copy and distribute
verbatim copies of this license document, but changing it is not allowed.
```

```
[This is the first released version of the library GPL. It is numbered 2 because
it goes with version 2 of the ordinary GPL.]
```

Preamble

The licenses for most software are designed to take away your freedom to share and change it. By contrast, the GNU General Public Licenses are intended to guarantee your freedom to share and change free software--to make sure the software is free for all its users.

This license, the Library General Public License, applies to some specially designated Free Software Foundation software, and to any other libraries whose authors decide to use it. You can use it for your libraries, too.

When we speak of free software, we are referring to freedom, not price. Our General Public Licenses are designed to make sure that you have the freedom to distribute copies of free software (and charge for this service if you wish), that you receive source code or can get it if you want it, that you can change the software or use pieces of it in new free programs; and that you know you can do these things.

To protect your rights, we need to make restrictions that forbid anyone to deny you these rights or to ask you to surrender the rights. These restrictions translate to certain responsibilities for you if you distribute copies of the library, or if you modify it.

For example, if you distribute copies of the library, whether gratis or for a fee, you must give the recipients all the rights that we gave you. You must make sure that they, too, receive or can get the source code. If you link a program with the library, you must provide complete object files to the recipients so that they can relink them with the library, after making changes to the library and recompiling it. And you must show them these terms so they know their rights.

Our method of protecting your rights has two steps: (1) copyright the library, and (2) offer you this license which gives you legal permission to copy, distribute and/or modify the library.

Also, for each distributor's protection, we want to make certain that everyone understands that there is no warranty for this free library. If the library is modified by someone else and passed on, we want its recipients to know that what they have is not the original version, so that any problems introduced by others will not reflect on the original authors' reputations.

Finally, any free program is threatened constantly by software patents. We wish to avoid the danger that companies distributing free software will individually obtain patent licenses, thus in effect transforming the program into proprietary software. To prevent this, we have made it clear that any patent must be licensed for everyone's free use or not licensed at all.

Most GNU software, including some libraries, is covered by the ordinary GNU General Public License, which was designed for utility programs. This license, the GNU Library General Public License, applies to certain designated libraries. This license is quite different from the ordinary one; be sure to read it in full, and don't assume that anything in it is the same as in the ordinary license.

The reason we have a separate public license for some libraries is that they blur the distinction we usually make between modifying or adding to a program and simply using it. Linking a program with a library, without changing the library, is in some sense simply using the library, and is analogous to running a utility program or application program. However, in a textual and legal sense, the linked executable is a combined work, a derivative of the original library, and the ordinary General Public License treats it as such.

Because of this blurred distinction, using the ordinary General Public License for libraries did not effectively promote software sharing, because most developers did not use the libraries. We concluded that weaker conditions might promote sharing better.

However, unrestricted linking of non-free programs would deprive the users of those programs of all benefit from the free status of the libraries themselves. This Library General Public License is intended to permit developers of non-free programs to use free libraries, while preserving your freedom as a user of such

programs to change the free libraries that are incorporated in them. (We have not seen how to achieve this as regards changes in header files, but we have achieved it as regards changes in the actual functions of the Library.) The hope is that this will lead to faster development of free libraries.

The precise terms and conditions for copying, distribution and modification follow. Pay close attention to the difference between a "work based on the library" and a "work that uses the library". The former contains code derived from the library, while the latter only works together with the library.

Note that it is possible for a library to be covered by the ordinary General Public License rather than by this special one.

GNU LIBRARY GENERAL PUBLIC LICENSE TERMS AND CONDITIONS FOR COPYING,
DISTRIBUTION AND MODIFICATION

0. This License Agreement applies to any software library which contains a notice placed by the copyright holder or other authorized party saying it may be distributed under the terms of this Library General Public License (also called "this License"). Each licensee is addressed as "you".

A "library" means a collection of software functions and/or data prepared so as to be conveniently linked with application programs (which use some of those functions and data) to form executables.

The "Library", below, refers to any such software library or work which has been distributed under these terms. A "work based on the Library" means either the Library or any derivative work under copyright law: that is to say, a work containing the Library or a portion of it, either verbatim or with modifications and/or translated straightforwardly into another language. (Hereinafter, translation is included without limitation in the term "modification".)

"Source code" for a work means the preferred form of the work for making modifications to it. For a library, complete source code means all the source code for all modules it contains, plus any associated interface definition files, plus the scripts used to control compilation and installation of the library.

Activities other than copying, distribution and modification are not covered by this License; they are outside its scope. The act of running a program using the Library is not restricted, and output from such a program is covered only if its contents constitute a work based on the Library (independent of the use of the Library in a tool for writing it). Whether that is true depends on what the Library does and what the program that uses the Library does. 1. You may copy and distribute verbatim copies of the Library's complete source code as you receive it, in any medium, provided that you conspicuously and appropriately publish on each copy an appropriate copyright notice and disclaimer of warranty; keep intact all the notices that refer to this License and to the absence of any warranty; and distribute a copy of this License along with the Library.

You may charge a fee for the physical act of transferring a copy, and you may at your option offer warranty protection in exchange for a fee.

2. You may modify your copy or copies of the Library or any portion of it, thus forming a work based on the Library, and copy and distribute such modifications or work under the terms of Section 1 above, provided that you also meet all of these conditions:

a) The modified work must itself be a software library.

b) You must cause the files modified to carry prominent notices stating that you changed the files and the date of any change.

c) You must cause the whole of the work to be licensed at no charge to all third parties under the terms of this License.

d) If a facility in the modified Library refers to a function or a table of data to be supplied by an application program that uses the facility, other than as an argument passed when the facility is invoked, then you must make a good faith effort to ensure that, in the event an application does not supply such function or table, the facility still operates, and performs whatever part of its purpose remains meaningful.

(For example, a function in a library to compute square roots has a purpose that is entirely well-defined independent of the application. Therefore, Subsection 2d requires that any application-supplied function or table used by this function must be optional: if the application does not supply it, the square root function must still compute square roots.)

These requirements apply to the modified work as a whole. If identifiable sections of that work are not derived from the Library, and can be reasonably considered independent and separate works in themselves, then this License, and its terms, do not apply to those sections when you distribute them as separate works. But when you distribute the same sections as part of a whole which is a work based on the Library, the distribution of the whole must be on the terms of this License, whose permissions for other licensees extend to the entire whole, and thus to each and every part regardless of who wrote it.

Thus, it is not the intent of this section to claim rights or contest your rights to work written entirely by you; rather, the intent is to exercise the right to control the distribution of derivative or collective works based on the Library.

In addition, mere aggregation of another work not based on the Library with the Library (or with a work based on the Library) on a volume of a storage or distribution medium does not bring the other work under the scope of this License.

3. You may opt to apply the terms of the ordinary GNU General Public License instead of this License to a given copy of the Library. To do this, you must alter all the notices that refer to this License, so that they refer to the ordinary GNU General Public License, version 2, instead of to this License. (If a newer version than version 2 of the ordinary GNU General Public License has appeared, then you can specify that version instead if you wish.) Do not make any other change in these notices.

Once this change is made in a given copy, it is irreversible for that copy, so the ordinary GNU General Public License applies to all subsequent copies and derivative works made from that copy.

This option is useful when you wish to copy part of the code of the Library into a program that is not a library.

4. You may copy and distribute the Library (or a portion or derivative of it, under Section 2) in object code or executable form under the terms of Sections 1 and 2 above provided that you accompany it with the complete corresponding machine-readable source code, which must be distributed under the terms of Sections 1 and 2 above on a medium customarily used for software interchange.

If distribution of object code is made by offering access to copy from a designated place, then offering equivalent access to copy the source code from the same place satisfies the requirement to distribute the source code, even though third parties are not compelled to copy the source along with the object code.

5. A program that contains no derivative of any portion of the Library, but is designed to work with the Library by being compiled or linked with it, is called a "work that uses the Library". Such a work, in isolation, is not a derivative work of the Library, and therefore falls outside the scope of this License.

However, linking a "work that uses the Library" with the Library creates an executable that is a derivative of the Library (because it contains portions of the Library), rather than a "work that uses the library". The executable is therefore covered by this License. Section 6 states terms for distribution of such executables.

When a "work that uses the Library" uses material from a header file that is part of the Library, the object code for the work may be a derivative work of the Library even though the source code is not. Whether this is true is especially significant if the work can be linked without the Library, or if the work is itself a library. The threshold for this to be true is not precisely defined by law.

If such an object file uses only numerical parameters, data structure layouts and accessors, and small macros and small inline functions (ten lines or less in length), then the use of the object file is unrestricted, regardless of whether it is legally a derivative work. (Executables containing this object code plus portions of the Library will still fall under Section 6.)

Otherwise, if the work is a derivative of the Library, you may distribute the object code for the work under the terms of Section 6. Any executables containing that work also fall under Section 6, whether or not they are linked directly with the Library itself.

6. As an exception to the Sections above, you may also compile or link a "work that uses the Library" with the Library to produce a work containing portions of the Library, and distribute that work under terms of your choice, provided that the terms permit modification of the work for the customer's own use and reverse engineering for debugging such modifications.

You must give prominent notice with each copy of the work that the Library is used in it and that the Library and its use are covered by this License. You must supply a copy of this License. If the work during execution displays copyright notices, you must include the copyright notice for the Library among them, as well as a reference directing the user to the copy of this License. Also, you must do one of these things:

a) Accompany the work with the complete corresponding machine-readable source code for the Library including whatever changes were used in the work (which must be distributed under Sections 1 and 2 above); and, if the work is an executable linked with the Library, with the complete machine-readable "work that uses the Library", as object code and/or source code, so that the user can modify the Library and then relink to produce a modified executable containing the modified Library. (It is understood that the user who changes the contents of definitions files in the Library will not necessarily be able to recompile the application to use the modified definitions.)

b) Accompany the work with a written offer, valid for at least three years, to give the same user the materials specified in Subsection 6a, above, for a charge no more than the cost of performing this distribution.

c) If distribution of the work is made by offering access to copy from a designated place, offer equivalent access to copy the above specified materials from the same place.

d) Verify that the user has already received a copy of these materials or that you have already sent this user a copy.

For an executable, the required form of the "work that uses the Library" must include any data and utility programs needed for reproducing the executable from it. However, as a special exception, the source code distributed need not include anything that is normally distributed (in either source or binary form) with the major components (compiler, kernel, and so on) of the operating system on which the executable runs, unless that component itself accompanies the executable.

It may happen that this requirement contradicts the license restrictions of other proprietary libraries that do not normally accompany the operating system. Such a contradiction means you cannot use both them and the Library together in an executable that you distribute.

7. You may place library facilities that are a work based on the Library side-by-side in a single library together with other library facilities not covered by this License, and distribute such a combined library, provided that the separate distribution of the work based on the Library and of the other library facilities is otherwise permitted, and provided that you do these two things:

a) Accompany the combined library with a copy of the same work based on the Library, uncombined with any other library facilities. This must be distributed under the terms of the Sections above.

b) Give prominent notice with the combined library of the fact that part of it is a work based on the Library, and explaining where to find the accompanying uncombined form of the same work.

8. You may not copy, modify, sublicense, link with, or distribute the Library except as expressly provided under this License. Any attempt otherwise to copy, modify, sublicense, link with, or distribute the Library is void, and will automatically terminate your rights under this License. However, parties who have received copies, or rights, from you under this License will not have their licenses terminated so long as such parties remain in full compliance.

9. You are not required to accept this License, since you have not signed it. However, nothing else grants you permission to modify or distribute the Library or its derivative works. These actions are prohibited by law if you do not accept this License. Therefore, by modifying or distributing the Library (or any work based on the Library), you indicate your acceptance of this License to do so, and all its terms and conditions for copying, distributing or modifying the Library or works based on it.

10. Each time you redistribute the Library (or any work based on the Library), the recipient automatically receives a license from the original licensor to copy, distribute, link with or modify the Library subject to these terms and conditions. You may not impose any further restrictions on the recipients' exercise of the rights granted herein. You are not responsible for enforcing compliance by third parties to this License.

11. If, as a consequence of a court judgment or allegation of patent infringement or for any other reason (not limited to patent issues), conditions are imposed on you (whether by court order, agreement or otherwise) that contradict the conditions of this License, they do not excuse you from the conditions of this License. If you cannot distribute so as to satisfy simultaneously your obligations under this License and any other pertinent obligations, then as a consequence you may not distribute the Library at all. For example, if a patent license would not permit royalty-free redistribution of the Library by all those who receive copies directly or indirectly through you, then the only way you could satisfy both it and this License would be to refrain entirely from distribution of the Library.

If any portion of this section is held invalid or unenforceable under any particular circumstance, the balance of the section is intended to apply, and the section as a whole is intended to apply in other circumstances.

It is not the purpose of this section to induce you to infringe any patents or other property right claims or to contest validity of any such claims; this section has the sole purpose of protecting the integrity of the free software distribution system which is implemented by public license practices. Many people have made generous contributions to the wide range of software distributed through that system in reliance on consistent application of that system; it is up to the author/donor to decide if he or she is willing to distribute software through any other system and a licensee cannot impose that choice.

This section is intended to make thoroughly clear what is believed to be a consequence of the rest of this License.

12. If the distribution and/or use of the Library is restricted in certain countries either by patents or by copyrighted interfaces, the original copyright holder who places the Library under this License may add an explicit geographical

distribution limitation excluding those countries, so that distribution is permitted only in or among countries not thus excluded. In such case, this License incorporates the limitation as if written in the body of this License.

13. The Free Software Foundation may publish revised and/or new versions of the Library General Public License from time to time. Such new versions will be similar in spirit to the present version, but may differ in detail to address new problems or concerns.

Each version is given a distinguishing version number. If the Library specifies a version number of this License which applies to it and "any later version", you have the option of following the terms and conditions either of that version or of any later version published by the Free Software Foundation. If the Library does not specify a license version number, you may choose any version ever published by the Free Software Foundation.

14. If you wish to incorporate parts of the Library into other free programs whose distribution conditions are incompatible with these, write to the author to ask for permission. For software which is copyrighted by the Free Software Foundation, write to the Free Software Foundation; we sometimes make exceptions for this. Our decision will be guided by the two goals of preserving the free status of all derivatives of our free software and of promoting the sharing and reuse of software generally.

NO WARRANTY

15. BECAUSE THE LIBRARY IS LICENSED FREE OF CHARGE, THERE IS NO WARRANTY FOR THE LIBRARY, TO THE EXTENT PERMITTED BY APPLICABLE LAW. EXCEPT WHEN OTHERWISE STATED IN WRITING THE COPYRIGHT HOLDERS AND/OR OTHER PARTIES PROVIDE THE LIBRARY "AS IS" WITHOUT WARRANTY OF ANY KIND, EITHER EXPRESSED OR IMPLIED, INCLUDING, BUT NOT LIMITED TO, THE IMPLIED WARRANTIES OF MERCHANTABILITY AND FITNESS FOR A PARTICULAR PURPOSE. THE ENTIRE RISK AS TO THE QUALITY AND PERFORMANCE OF THE LIBRARY IS WITH YOU. SHOULD THE LIBRARY PROVE DEFECTIVE, YOU ASSUME THE COST OF ALL NECESSARY SERVICING, REPAIR OR CORRECTION.

16. IN NO EVENT UNLESS REQUIRED BY APPLICABLE LAW OR AGREED TO IN WRITING WILL ANY COPYRIGHT HOLDER, OR ANY OTHER PARTY WHO MAY MODIFY AND/OR REDISTRIBUTE THE LIBRARY AS PERMITTED ABOVE, BE LIABLE TO YOU FOR DAMAGES, INCLUDING ANY GENERAL, SPECIAL, INCIDENTAL OR CONSEQUENTIAL DAMAGES ARISING OUT OF THE USE OR INABILITY TO USE THE LIBRARY (INCLUDING BUT NOT LIMITED TO LOSS OF DATA OR DATA BEING RENDERED INACCURATE OR LOSSES SUSTAINED BY YOU OR THIRD PARTIES OR A FAILURE OF THE LIBRARY TO OPERATE WITH ANY OTHER SOFTWARE), EVEN IF SUCH HOLDER OR OTHER PARTY HAS BEEN ADVISED OF THE POSSIBILITY OF SUCH DAMAGES.

END OF TERMS AND CONDITIONS

Appendix: How to Apply These Terms to Your New Libraries

If you develop a new library, and you want it to be of the greatest possible use to the public, we recommend making it free software that everyone can redistribute and change. You can do so by permitting redistribution under these terms (or, alternatively, under the terms of the ordinary General Public License).

To apply these terms, attach the following notices to the library. It is safest to attach them to the start of each source file to most effectively convey the exclusion of warranty; and each file should have at least the "copyright" line and a pointer to where the full notice is found.

```
<one line to give the library's name and a brief idea of what it does.>
Copyright (C) <year> <name of author>
```

This library is free software; you can redistribute it and/or modify it under the terms of the GNU Library General Public License as published by the Free Software Foundation; either version 2 of the License, or (at your option) any later version.

This library is distributed in the hope that it will be useful, but WITHOUT ANY WARRANTY; without even the implied warranty of MERCHANTABILITY or FITNESS FOR A PARTICULAR PURPOSE. See the GNU Library General Public License for more details.

You should have received a copy of the GNU Library General Public License along with this library; if not, write to the Free Software Foundation, Inc., 51 Franklin Street, Fifth Floor, Boston, MA 02110-1301, USA

Also add information on how to contact you by electronic and paper mail.

You should also get your employer (if you work as a programmer) or your school, if any, to sign a "copyright disclaimer" for the library, if necessary. Here is a sample; alter the names:

Yoyodyne, Inc., hereby disclaims all copyright interest in the library `Frob' (a library for tweaking knobs) written by James Random Hacker.

<signature of Ty Coon>, 1 April 1990 Ty Coon, President of Vice

That's all there is to it!

u-boot 2012.04.01

U-Boot is Free Software. It is copyrighted by Wolfgang Denk and many others who contributed code (see the actual source code for details). You can redistribute U-Boot and/or modify it under the terms of version 2 of the GNU General Public License as published by the Free Software Foundation. Most of it can also be distributed, at your option, under any later version of the GNU General Public License -- see individual files for exceptions.

NOTE! This license does *not* cover the so-called "standalone" applications that use U-Boot services by means of the jump table provided by U-Boot exactly for this purpose - this is merely considered normal use of U-Boot, and does *not* fall under the heading of "derived work".

The header files "include/image.h" and "include/asm-*/u-boot.h" define interfaces to U-Boot. Including these (unmodified) header files in another file is considered normal use of U-Boot, and does *not* fall under the heading of "derived work".

Also note that the GPL below is copyrighted by the Free Software Foundation, but the instance of code that it refers to (the U-Boot source code) is copyrighted by me and others who actually wrote it. -- Wolfgang Denk

=====

GNU GENERAL PUBLIC LICENSE Version 2, June 1991

Copyright (C) 1989, 1991 Free Software Foundation, Inc. 59 Temple Place, Suite 330, Boston, MA 02111-1307 USA Everyone is permitted to copy and distribute verbatim copies of this license document, but changing it is not allowed.

Preamble

The licenses for most software are designed to take away your freedom to share and change it. By contrast, the GNU General Public License is intended to guarantee your freedom to share and change free software--to make sure the software is free for all its users. This General Public License applies to most of the Free Software Foundation's software and to any other program whose authors commit to using it. (Some other Free Software Foundation software is covered by the GNU Library General Public License instead.) You can apply it to your programs, too.

When we speak of free software, we are referring to freedom, not price. Our General Public Licenses are designed to make sure that you have the freedom to distribute copies of free software (and charge for this service if you wish), that you receive source code or can get it if you want it, that you can change the software or use pieces of it in new free programs; and that you know you can do these things.

To protect your rights, we need to make restrictions that forbid anyone to deny you these rights or to ask you to surrender the rights. These restrictions translate to certain responsibilities for you if you distribute copies of the software, or if you modify it.

For example, if you distribute copies of such a program, whether gratis or for a fee, you must give the recipients all the rights that you have. You must make sure that they, too, receive or can get the source code. And you must show them these terms so they know their rights.

We protect your rights with two steps: (1) copyright the software, and (2) offer you this license which gives you legal permission to copy, distribute and/or modify the software.

Also, for each author's protection and ours, we want to make certain that everyone understands that there is no warranty for this free software. If the software is modified by someone else and passed on, we want its recipients to know that what they have is not the original, so that any problems introduced by others will not reflect on the original authors' reputations.

Finally, any free program is threatened constantly by software patents. We wish to avoid the danger that redistributors of a free program will individually obtain patent licenses, in effect making the program proprietary. To prevent this, we have made it clear that any patent must be licensed for everyone's free use or not licensed at all.

The precise terms and conditions for copying, distribution and modification follow.

GNU GENERAL PUBLIC LICENSE
TERMS AND CONDITIONS FOR COPYING, DISTRIBUTION AND MODIFICATION

0. This License applies to any program or other work which contains a notice placed by the copyright holder saying it may be distributed under the terms of this General Public License. The "Program", below, refers to any such program or work, and a "work based on the Program" means either the Program or any derivative work under copyright law: that is to say, a work containing the Program or a portion of it, either verbatim or with modifications and/or translated into another language. (Hereinafter, translation is included without limitation in the term "modification".) Each licensee is addressed as "you".

Activities other than copying, distribution and modification are not covered by this License; they are outside its scope. The act of running the Program is not restricted, and the output from the Program is covered only if its contents constitute a work based on the Program (independent of having been made by running the Program). Whether that is true depends on what the Program does.

1. You may copy and distribute verbatim copies of the Program's source code as you receive it, in any medium, provided that you conspicuously and appropriately publish on each copy an appropriate copyright notice and disclaimer of warranty; keep intact all the notices that refer to this License and to the absence of any warranty; and give any other recipients of the Program a copy of this License along with the Program.

You may charge a fee for the physical act of transferring a copy, and you may at your option offer warranty protection in exchange for a fee.

2. You may modify your copy or copies of the Program or any portion of it, thus forming a work based on the Program, and copy and distribute such modifications or work under the terms of Section 1 above, provided that you also meet all of these conditions:

a) You must cause the modified files to carry prominent notices stating that you changed the files and the date of any change.

b) You must cause any work that you distribute or publish, that in whole or in part contains or is derived from the Program or any part thereof, to be licensed as a whole at no charge to all third parties under the terms of this License.

c) If the modified program normally reads commands interactively when run, you must cause it, when started running for such interactive use in the most ordinary way, to print or display an announcement including an appropriate copyright notice and a notice that there is no warranty (or else, saying that you provide a warranty) and that users may redistribute the program under these conditions, and telling the user how to view a copy of this License. (Exception: if the Program itself is interactive but does not normally print such an announcement, your work based on the Program is not required to print an announcement.)

These requirements apply to the modified work as a whole. If identifiable sections of that work are not derived from the Program, and can be reasonably considered independent and separate works in themselves, then this License, and its terms, do not apply to those sections when you distribute them as separate works. But when you distribute the same sections as part of a whole which is a work based on the Program, the distribution of the whole must be on the terms of this License, whose permissions for other licensees extend to the entire whole, and thus to each and every part regardless of who wrote it.

Thus, it is not the intent of this section to claim rights or contest your rights to work written entirely by you; rather, the intent is to exercise the right to control the distribution of derivative or collective works based on the Program.

In addition, mere aggregation of another work not based on the Program with the Program (or with a work based on the Program) on a volume of a storage or distribution medium does not bring the other work under the scope of this License.

3. You may copy and distribute the Program (or a work based on it, under Section 2) in object code or executable form under the terms of Sections 1 and 2 above provided that you also do one of the following:

a) Accompany it with the complete corresponding machine-readable source code, which must be distributed under the terms of Sections 1 and 2 above on a medium customarily used for software interchange; or,

b) Accompany it with a written offer, valid for at least three years, to give any third party, for a charge no more than your cost of physically performing source distribution, a complete machine-readable copy of the corresponding source code, to be distributed under the terms of Sections 1 and 2 above on a medium customarily used for software interchange; or,

c) Accompany it with the information you received as to the offer to distribute corresponding source code. (This alternative is allowed only for noncommercial distribution and only if you received the program in object code or executable form with such an offer, in accord with Subsection b above.)

The source code for a work means the preferred form of the work for making modifications to it. For an executable work, complete source code means all the source code for all modules it contains, plus any associated interface definition files, plus the scripts used to control compilation and installation of the executable. However, as a special exception, the source code distributed need not include anything that is normally distributed (in either source or binary

form) with the major components (compiler, kernel, and so on) of the operating system on which the executable runs, unless that component itself accompanies the executable.

If distribution of executable or object code is made by offering access to copy from a designated place, then offering equivalent access to copy the source code from the same place counts as distribution of the source code, even though third parties are not compelled to copy the source along with the object code.

4. You may not copy, modify, sublicense, or distribute the Program except as expressly provided under this License. Any attempt otherwise to copy, modify, sublicense or distribute the Program is void, and will automatically terminate your rights under this License. However, parties who have received copies, or rights, from you under this License will not have their licenses terminated so long as such parties remain in full compliance.

5. You are not required to accept this License, since you have not signed it. However, nothing else grants you permission to modify or distribute the Program or its derivative works. These actions are prohibited by law if you do not accept this License. Therefore, by modifying or distributing the Program (or any work based on the Program), you indicate your acceptance of this License to do so, and all its terms and conditions for copying, distributing or modifying the Program or works based on it.

6. Each time you redistribute the Program (or any work based on the Program), the recipient automatically receives a license from the original licensor to copy, distribute or modify the Program subject to these terms and conditions. You may not impose any further restrictions on the recipients' exercise of the rights granted herein. You are not responsible for enforcing compliance by third parties to this License.

7. If, as a consequence of a court judgment or allegation of patent infringement or for any other reason (not limited to patent issues), conditions are imposed on you (whether by court order, agreement or otherwise) that contradict the conditions of this License, they do not excuse you from the conditions of this License. If you cannot distribute so as to satisfy simultaneously your obligations under this License and any other pertinent obligations, then as a consequence you may not distribute the Program at all. For example, if a patent license would not permit royalty-free redistribution of the Program by all those who receive copies directly or indirectly through you, then the only way you could satisfy both it and this License would be to refrain entirely from distribution of the Program.

If any portion of this section is held invalid or unenforceable under any particular circumstance, the balance of the section is intended to apply and the section as a whole is intended to apply in other circumstances.

It is not the purpose of this section to induce you to infringe any patents or other property right claims or to contest validity of any such claims; this section has the sole purpose of protecting the integrity of the free software distribution system, which is implemented by public license practices. Many people have made generous contributions to the wide range of software distributed through that system in reliance on consistent application of that system; it is up to the author/donor to decide if he or she is willing to distribute software through any other system and a licensee cannot impose that choice.

This section is intended to make thoroughly clear what is believed to be a consequence of the rest of this License.

8. If the distribution and/or use of the Program is restricted in certain countries either by patents or by copyrighted interfaces, the original copyright holder who places the Program under this License may add an explicit geographical distribution limitation excluding those countries, so that distribution is permitted only in or among countries not thus excluded. In such case, this License incorporates the limitation as if written in the body of this License.

9. The Free Software Foundation may publish revised and/or new versions of the General Public License from time to time. Such new versions will be similar in spirit to the present version, but may differ in detail to address new problems or concerns.

Each version is given a distinguishing version number. If the Program specifies a version number of this License which applies to it and "any later version", you have the option of following the terms and conditions either of that version or of any later version published by the Free Software Foundation. If the Program does not specify a version number of this License, you may choose any version ever published by the Free Software Foundation.

10. If you wish to incorporate parts of the Program into other free programs whose distribution conditions are different, write to the author to ask for permission. For software which is copyrighted by the Free Software Foundation, write to the Free Software Foundation; we sometimes make exceptions for this. Our decision will be guided by the two goals of preserving the free status of all derivatives of our free software and of promoting the sharing and reuse of software generally.

NO WARRANTY

11. BECAUSE THE PROGRAM IS LICENSED FREE OF CHARGE, THERE IS NO WARRANTY FOR THE PROGRAM, TO THE EXTENT PERMITTED BY APPLICABLE LAW. EXCEPT WHEN OTHERWISE STATED IN WRITING THE COPYRIGHT HOLDERS AND/OR OTHER PARTIES PROVIDE THE PROGRAM "AS IS" WITHOUT WARRANTY OF ANY KIND, EITHER EXPRESSED OR IMPLIED, INCLUDING, BUT NOT LIMITED TO, THE IMPLIED WARRANTIES OF MERCHANTABILITY AND FITNESS FOR A PARTICULAR PURPOSE. THE ENTIRE RISK AS TO THE QUALITY AND PERFORMANCE OF THE PROGRAM IS WITH YOU. SHOULD THE PROGRAM PROVE DEFECTIVE, YOU ASSUME THE COST OF ALL NECESSARY SERVICING, REPAIR OR CORRECTION.

12. IN NO EVENT UNLESS REQUIRED BY APPLICABLE LAW OR AGREED TO IN WRITING WILL ANY COPYRIGHT HOLDER, OR ANY OTHER PARTY WHO MAY MODIFY AND/OR REDISTRIBUTE THE PROGRAM AS PERMITTED ABOVE, BE LIABLE TO YOU FOR DAMAGES, INCLUDING ANY GENERAL, SPECIAL, INCIDENTAL OR CONSEQUENTIAL DAMAGES ARISING OUT OF THE USE OR INABILITY TO USE THE PROGRAM (INCLUDING BUT NOT LIMITED TO LOSS OF DATA OR DATA BEING RENDERED INACCURATE OR LOSSES SUSTAINED BY YOU OR THIRD PARTIES OR A FAILURE OF THE PROGRAM TO OPERATE WITH ANY OTHER PROGRAMS), EVEN IF SUCH HOLDER OR OTHER PARTY HAS BEEN ADVISED OF THE POSSIBILITY OF SUCH DAMAGES.

END OF TERMS AND CONDITIONS

uClibc 0.9.33.2

GNU LESSER GENERAL PUBLIC LICENSE

Version 2.1, February 1999

Copyright (C) 1991, 1999 Free Software Foundation, Inc. 51 Franklin St, Fifth Floor, Boston, MA 02110-1301 USA Everyone is permitted to copy and distribute verbatim copies of this license document, but changing it is not allowed.

[This is the first released version of the Lesser GPL. It also counts as the successor of the GNU Library Public License, version 2, hence the version number 2.1.]

Preamble

The licenses for most software are designed to take away your freedom to share and change it. By contrast, the GNU General Public Licenses are intended to guarantee your freedom to share and change free software--to make sure the software is free for all its users.

This license, the Lesser General Public License, applies to some specially designated software packages--typically libraries--of the Free Software Foundation and other authors who decide to use it. You can use it too, but we

suggest you first think carefully about whether this license or the ordinary General Public License is the better strategy to use in any particular case, based on the explanations below.

When we speak of free software, we are referring to freedom of use, not price. Our General Public Licenses are designed to make sure that you have the freedom to distribute copies of free software (and charge for this service if you wish); that you receive source code or can get it if you want it; that you can change the software and use pieces of it in new free programs; and that you are informed that you can do these things.

To protect your rights, we need to make restrictions that forbid distributors to deny you these rights or to ask you to surrender these rights. These restrictions translate to certain responsibilities for you if you distribute copies of the library or if you modify it.

For example, if you distribute copies of the library, whether gratis or for a fee, you must give the recipients all the rights that we gave you. You must make sure that they, too, receive or can get the source code. If you link other code with the library, you must provide complete object files to the recipients, so that they can relink them with the library after making changes to the library and recompiling it. And you must show them these terms so they know their rights.

We protect your rights with a two-step method: (1) we copyright the library, and (2) we offer you this license, which gives you legal permission to copy, distribute and/or modify the library.

To protect each distributor, we want to make it very clear that there is no warranty for the free library. Also, if the library is modified by someone else and passed on, the recipients should know that what they have is not the original version, so that the original author's reputation will not be affected by problems that might be introduced by others.

Finally, software patents pose a constant threat to the existence of any free program. We wish to make sure that a company cannot effectively restrict the users of a free program by obtaining a restrictive license from a patent holder. Therefore, we insist that any patent license obtained for a version of the library must be consistent with the full freedom of use specified in this license.

Most GNU software, including some libraries, is covered by the ordinary GNU General Public License. This license, the GNU Lesser General Public License, applies to certain designated libraries, and is quite different from the ordinary General Public License. We use this license for certain libraries in order to permit linking those libraries into non-free programs.

When a program is linked with a library, whether statically or using a shared library, the combination of the two is legally speaking a combined work, a derivative of the original library. The ordinary General Public License therefore permits such linking only if the entire combination fits its criteria of freedom. The Lesser General Public License permits more lax criteria for linking other code with the library.

We call this license the "Lesser" General Public License because it does Less to protect the user's freedom than the ordinary General Public License. It also provides other free software developers Less of an advantage over competing non-free programs. These disadvantages are the reason we use the ordinary General Public License for many libraries. However, the Lesser license provides advantages in certain special circumstances.

For example, on rare occasions, there may be a special need to encourage the widest possible use of a certain library, so that it becomes a de-facto standard. To achieve this, non-free programs must be allowed to use the library. A more frequent case is that a free library does the same job as widely used non-free libraries. In this case, there is little to gain by limiting the free library to free software only, so we use the Lesser General Public License.

In other cases, permission to use a particular library in non-free programs enables a greater number of people to use a large body of free software. For example, permission to use the GNU C Library in non-free programs enables many more people to use the whole GNU operating system, as well as its variant, the GNU/Linux operating system.

Although the Lesser General Public License is less protective of the users' freedom, it does ensure that the user of a program that is linked with the Library has the freedom and the wherewithal to run that program using a modified version of the Library.

The precise terms and conditions for copying, distribution and modification follow. Pay close attention to the difference between a "work based on the library" and a "work that uses the library". The former contains code derived from the library, whereas the latter must be combined with the library in order to run.

GNU LESSER GENERAL PUBLIC LICENSE TERMS AND CONDITIONS FOR COPYING,
DISTRIBUTION AND MODIFICATION

0. This License Agreement applies to any software library or other program which contains a notice placed by the copyright holder or other authorized party saying it may be distributed under the terms of this Lesser General Public License (also called "this License"). Each licensee is addressed as "you".

A "library" means a collection of software functions and/or data prepared so as to be conveniently linked with application programs (which use some of those functions and data) to form executables.

The "Library", below, refers to any such software library or work which has been distributed under these terms. A "work based on the Library" means either the Library or any derivative work under copyright law: that is to say, a work containing the Library or a portion of it, either verbatim or with modifications and/or translated straightforwardly into another language. (Hereinafter, translation is included without limitation in the term "modification".)

"Source code" for a work means the preferred form of the work for making modifications to it. For a library, complete source code means all the source code for all modules it contains, plus any associated interface definition files, plus the scripts used to control compilation and installation of the library.

Activities other than copying, distribution and modification are not covered by this License; they are outside its scope. The act of running a program using the Library is not restricted, and output from such a program is covered only if its contents constitute a work based on the Library (independent of the use of the Library in a tool for writing it). Whether that is true depends on what the Library does and what the program that uses the Library does.

1. You may copy and distribute verbatim copies of the Library's complete source code as you receive it, in any medium, provided that you conspicuously and appropriately publish on each copy an appropriate copyright notice and disclaimer of warranty; keep intact all the notices that refer to this License and to the absence of any warranty; and distribute a copy of this License along with the Library.

You may charge a fee for the physical act of transferring a copy, and you may at your option offer warranty protection in exchange for a fee.

2. You may modify your copy or copies of the Library or any portion of it, thus forming a work based on the Library, and copy and distribute such modifications or work under the terms of Section 1 above, provided that you also meet all of these conditions:

- a) The modified work must itself be a software library.
- b) You must cause the files modified to carry prominent notices stating that you changed the files and the date of any change.

c) You must cause the whole of the work to be licensed at no charge to all third parties under the terms of this License.

d) If a facility in the modified Library refers to a function or a table of data to be supplied by an application program that uses the facility, other than as an argument passed when the facility is invoked, then you must make a good faith effort to ensure that, in the event an application does not supply such function or table, the facility still operates, and performs whatever part of its purpose remains meaningful.

(For example, a function in a library to compute square roots has a purpose that is entirely well-defined independent of the application. Therefore, Subsection 2d requires that any application-supplied function or table used by this function must be optional: if the application does not supply it, the square root function must still compute square roots.)

These requirements apply to the modified work as a whole. If identifiable sections of that work are not derived from the Library, and can be reasonably considered independent and separate works in themselves, then this License, and its terms, do not apply to those sections when you distribute them as separate works. But when you distribute the same sections as part of a whole which is a work based on the Library, the distribution of the whole must be on the terms of this License, whose permissions for other licensees extend to the entire whole, and thus to each and every part regardless of who wrote it.

Thus, it is not the intent of this section to claim rights or contest your rights to work written entirely by you; rather, the intent is to exercise the right to control the distribution of derivative or collective works based on the Library.

In addition, mere aggregation of another work not based on the Library with the Library (or with a work based on the Library) on a volume of a storage or distribution medium does not bring the other work under the scope of this License.

3. You may opt to apply the terms of the ordinary GNU General Public License instead of this License to a given copy of the Library. To do this, you must alter all the notices that refer to this License, so that they refer to the ordinary GNU General Public License, version 2, instead of to this License. (If a newer version than version 2 of the ordinary GNU General Public License has appeared, then you can specify that version instead if you wish.) Do not make any other change in these notices.

Once this change is made in a given copy, it is irreversible for that copy, so the ordinary GNU General Public License applies to all subsequent copies and derivative works made from that copy.

This option is useful when you wish to copy part of the code of the Library into a program that is not a library.

4. You may copy and distribute the Library (or a portion or derivative of it, under Section 2) in object code or executable form under the terms of Sections 1 and 2 above provided that you accompany it with the complete corresponding machine-readable source code, which must be distributed under the terms of Sections 1 and 2 above on a medium customarily used for software interchange.

If distribution of object code is made by offering access to copy from a designated place, then offering equivalent access to copy the source code from the same place satisfies the requirement to distribute the source code, even though third parties are not compelled to copy the source along with the object code.

5. A program that contains no derivative of any portion of the Library, but is designed to work with the Library by being compiled or linked with it, is called a "work that uses the Library". Such a work, in isolation, is not a derivative work of the Library, and therefore falls outside the scope of this License.

However, linking a "work that uses the Library" with the Library creates an executable that is a derivative of the Library (because it contains portions of the Library), rather than a "work that uses the library". The executable is therefore covered by this License. Section 6 states terms for distribution of such executables.

When a "work that uses the Library" uses material from a header file that is part of the Library, the object code for the work may be a derivative work of the Library even though the source code is not. Whether this is true is especially significant if the work can be linked without the Library, or if the work is itself a library. The threshold for this to be true is not precisely defined by law.

If such an object file uses only numerical parameters, data structure layouts and accessors, and small macros and small inline functions (ten lines or less in length), then the use of the object file is unrestricted, regardless of whether it is legally a derivative work. (Executables containing this object code plus portions of the Library will still fall under Section 6.)

Otherwise, if the work is a derivative of the Library, you may distribute the object code for the work under the terms of Section 6. Any executables containing that work also fall under Section 6, whether or not they are linked directly with the Library itself.

6. As an exception to the Sections above, you may also combine or link a "work that uses the Library" with the Library to produce a work containing portions of the Library, and distribute that work under terms of your choice, provided that the terms permit modification of the work for the customer's own use and reverse engineering for debugging such modifications.

You must give prominent notice with each copy of the work that the Library is used in it and that the Library and its use are covered by this License. You must supply a copy of this License. If the work during execution displays copyright notices, you must include the copyright notice for the Library among them, as well as a reference directing the user to the copy of this License. Also, you must do one of these things:

a) Accompany the work with the complete corresponding machine-readable source code for the Library including whatever changes were used in the work (which must be distributed under Sections 1 and 2 above); and, if the work is an executable linked with the Library, with the complete machine-readable "work that uses the Library", as object code and/or source code, so that the user can modify the Library and then relink to produce a modified executable containing the modified Library. (It is understood that the user who changes the contents of definitions files in the Library will not necessarily be able to recompile the application to use the modified definitions.)

b) Use a suitable shared library mechanism for linking with the Library. A suitable mechanism is one that (1) uses at run time a copy of the library already present on the user's computer system, rather than copying library functions into the executable, and (2) will operate properly with a modified version of the library, if the user installs one, as long as the modified version is interface-compatible with the version that the work was made with.

c) Accompany the work with a written offer, valid for at least three years, to give the same user the materials specified in Subsection 6a, above, for a charge no more than the cost of performing this distribution.

d) If distribution of the work is made by offering access to copy from a designated place, offer equivalent access to copy the above specified materials from the same place.

e) Verify that the user has already received a copy of these materials or that you have already sent this user a copy.

For an executable, the required form of the "work that uses the Library" must include any data and utility programs needed for reproducing the executable from it. However, as a special exception, the materials to be distributed need not

include anything that is normally distributed (in either source or binary form) with the major components (compiler, kernel, and so on) of the operating system on which the executable runs, unless that component itself accompanies the executable.

It may happen that this requirement contradicts the license restrictions of other proprietary libraries that do not normally accompany the operating system. Such a contradiction means you cannot use both them and the Library together in an executable that you distribute.

7. You may place library facilities that are a work based on the Library side-by-side in a single library together with other library facilities not covered by this License, and distribute such a combined library, provided that the separate distribution of the work based on the Library and of the other library facilities is otherwise permitted, and provided that you do these two things:

a) Accompany the combined library with a copy of the same work based on the Library, uncombined with any other library facilities. This must be distributed under the terms of the Sections above.

b) Give prominent notice with the combined library of the fact that part of it is a work based on the Library, and explaining where to find the accompanying uncombined form of the same work.

8. You may not copy, modify, sublicense, link with, or distribute the Library except as expressly provided under this License. Any attempt otherwise to copy, modify, sublicense, link with, or distribute the Library is void, and will automatically terminate your rights under this License. However, parties who have received copies, or rights, from you under this License will not have their licenses terminated so long as such parties remain in full compliance.

9. You are not required to accept this License, since you have not signed it. However, nothing else grants you permission to modify or distribute the Library or its derivative works. These actions are prohibited by law if you do not accept this License. Therefore, by modifying or distributing the Library (or any work based on the Library), you indicate your acceptance of this License to do so, and all its terms and conditions for copying, distributing or modifying the Library or works based on it.

10. Each time you redistribute the Library (or any work based on the Library), the recipient automatically receives a license from the original licensor to copy, distribute, link with or modify the Library subject to these terms and conditions. You may not impose any further restrictions on the recipients' exercise of the rights granted herein. You are not responsible for enforcing compliance by third parties with this License.

11. If, as a consequence of a court judgment or allegation of patent infringement or for any other reason (not limited to patent issues), conditions are imposed on you (whether by court order, agreement or otherwise) that contradict the conditions of this License, they do not excuse you from the conditions of this License. If you cannot distribute so as to satisfy simultaneously your obligations under this License and any other pertinent obligations, then as a consequence you may not distribute the Library at all. For example, if a patent license would not permit royalty-free redistribution of the Library by all those who receive copies directly or indirectly through you, then the only way you could satisfy both it and this License would be to refrain entirely from distribution of the Library.

If any portion of this section is held invalid or unenforceable under any particular circumstance, the balance of the section is intended to apply, and the section as a whole is intended to apply in other circumstances.

It is not the purpose of this section to induce you to infringe any patents or other property right claims or to contest validity of any such claims; this section has the sole purpose of protecting the integrity of the free software distribution system which is implemented by public license practices. Many people have made generous contributions to the wide range of software distributed through that

system in reliance on consistent application of that system; it is up to the author/donor to decide if he or she is willing to distribute software through any other system and a licensee cannot impose that choice.

This section is intended to make thoroughly clear what is believed to be a consequence of the rest of this License.

12. If the distribution and/or use of the Library is restricted in certain countries either by patents or by copyrighted interfaces, the original copyright holder who places the Library under this License may add an explicit geographical distribution limitation excluding those countries, so that distribution is permitted only in or among countries not thus excluded. In such case, this License incorporates the limitation as if written in the body of this License.

13. The Free Software Foundation may publish revised and/or new versions of the Lesser General Public License from time to time. Such new versions will be similar in spirit to the present version, but may differ in detail to address new problems or concerns.

Each version is given a distinguishing version number. If the Library specifies a version number of this License which applies to it and "any later version", you have the option of following the terms and conditions either of that version or of any later version published by the Free Software Foundation. If the Library does not specify a license version number, you may choose any version ever published by the Free Software Foundation.

14. If you wish to incorporate parts of the Library into other free programs whose distribution conditions are incompatible with these, write to the author to ask for permission. For software which is copyrighted by the Free Software Foundation, write to the Free Software Foundation; we sometimes make exceptions for this. Our decision will be guided by the two goals of preserving the free status of all derivatives of our free software and of promoting the sharing and reuse of software generally.

NO WARRANTY

15. BECAUSE THE LIBRARY IS LICENSED FREE OF CHARGE, THERE IS NO WARRANTY FOR THE LIBRARY, TO THE EXTENT PERMITTED BY APPLICABLE LAW. EXCEPT WHEN OTHERWISE STATED IN WRITING THE COPYRIGHT HOLDERS AND/OR OTHER PARTIES PROVIDE THE LIBRARY "AS IS" WITHOUT WARRANTY OF ANY KIND, EITHER EXPRESSED OR IMPLIED, INCLUDING, BUT NOT LIMITED TO, THE IMPLIED WARRANTIES OF MERCHANTABILITY AND FITNESS FOR A PARTICULAR PURPOSE. THE ENTIRE RISK AS TO THE QUALITY AND PERFORMANCE OF THE LIBRARY IS WITH YOU. SHOULD THE LIBRARY PROVE DEFECTIVE, YOU ASSUME THE COST OF ALL NECESSARY SERVICING, REPAIR OR CORRECTION.

16. IN NO EVENT UNLESS REQUIRED BY APPLICABLE LAW OR AGREED TO IN WRITING WILL ANY COPYRIGHT HOLDER, OR ANY OTHER PARTY WHO MAY MODIFY AND/OR REDISTRIBUTE THE LIBRARY AS PERMITTED ABOVE, BE LIABLE TO YOU FOR DAMAGES, INCLUDING ANY GENERAL, SPECIAL, INCIDENTAL OR CONSEQUENTIAL DAMAGES ARISING OUT OF THE USE OR INABILITY TO USE THE LIBRARY (INCLUDING BUT NOT LIMITED TO LOSS OF DATA OR DATA BEING RENDERED INACCURATE OR LOSSES SUSTAINED BY YOU OR THIRD PARTIES OR A FAILURE OF THE LIBRARY TO OPERATE WITH ANY OTHER SOFTWARE), EVEN IF SUCH HOLDER OR OTHER PARTY HAS BEEN ADVISED OF THE POSSIBILITY OF SUCH DAMAGES.

END OF TERMS AND CONDITIONS

How to Apply These Terms to Your New Libraries

If you develop a new library, and you want it to be of the greatest possible use to the public, we recommend making it free software that everyone can redistribute and change. You can do so by permitting redistribution under these terms (or, alternatively, under the terms of the ordinary General Public License).

To apply these terms, attach the following notices to the library. It is safest to attach them to the start of each source file to most effectively convey the exclusion of warranty; and each file should have at least the "copyright" line and a pointer to where the full notice is found.

<one line to give the library's name and a brief idea of what it does.>
 Copyright (C) <year> <name of author>

This library is free software; you can redistribute it and/or modify it under the terms of the GNU Lesser General Public License as published by the Free Software Foundation; either version 2.1 of the License, or (at your option) any later version.

This library is distributed in the hope that it will be useful, but WITHOUT ANY WARRANTY; without even the implied warranty of MERCHANTABILITY or FITNESS FOR A PARTICULAR PURPOSE. See the GNU Lesser General Public License for more details.

You should have received a copy of the GNU Lesser General Public License along with this library; if not, write to the Free Software Foundation, Inc., 51 Franklin St, Fifth Floor, Boston, MA 02110-1301 USA

Also add information on how to contact you by electronic and paper mail.

You should also get your employer (if you work as a programmer) or your school, if any, to sign a "copyright disclaimer" for the library, if necessary. Here is a sample; alter the names:

Yoyodyne, Inc., hereby disclaims all copyright interest in the library `Frob' (a library for tweaking knobs) written by James Random Hacker.

<signature of Ty Coon>, 1 April 1990 Ty Coon, President of Vice

That's all there is to it!

util-linux 2.20.1

GNU GENERAL PUBLIC LICENSE Version 2, June 1991

Copyright (C) 1989, 1991 Free Software Foundation, Inc. 51 Franklin Street, Fifth Floor, Boston, MA 02110-1301 USA Everyone is permitted to copy and distribute verbatim copies of this license document, but changing it is not allowed.

Preamble

The licenses for most software are designed to take away your freedom to share and change it. By contrast, the GNU General Public License is intended to guarantee your freedom to share and change free software--to make sure the software is free for all its users. This General Public License applies to most of the Free Software Foundation's software and to any other program whose authors commit to using it. (Some other Free Software Foundation software is covered by the GNU Library General Public License instead.) You can apply it to your programs, too.

When we speak of free software, we are referring to freedom, not price. Our General Public Licenses are designed to make sure that you have the freedom to distribute copies of free software (and charge for this service if you wish), that you receive source code or can get it if you want it, that you can change the software or use pieces of it in new free programs; and that you know you can do these things.

To protect your rights, we need to make restrictions that forbid anyone to deny you these rights or to ask you to surrender the rights. These restrictions translate to certain responsibilities for you if you distribute copies of the software, or if you modify it.

For example, if you distribute copies of such a program, whether gratis or for a fee, you must give the recipients all the rights that you have. You must make sure that they, too, receive or can get the source code. And you must show them these terms so they know their rights.

We protect your rights with two steps: (1) copyright the software, and (2) offer you this license which gives you legal permission to copy, distribute and/or modify the software.

Also, for each author's protection and ours, we want to make certain that everyone understands that there is no warranty for this free software. If the software is modified by someone else and passed on, we want its recipients to know that what they have is not the original, so that any problems introduced by others will not reflect on the original authors' reputations.

Finally, any free program is threatened constantly by software patents. We wish to avoid the danger that redistributors of a free program will individually obtain patent licenses, in effect making the program proprietary. To prevent this, we have made it clear that any patent must be licensed for everyone's free use or not licensed at all.

The precise terms and conditions for copying, distribution and modification follow.

GNU GENERAL PUBLIC LICENSE
TERMS AND CONDITIONS FOR COPYING, DISTRIBUTION AND MODIFICATION

0. This License applies to any program or other work which contains a notice placed by the copyright holder saying it may be distributed under the terms of this General Public License. The "Program", below, refers to any such program or work, and a "work based on the Program" means either the Program or any derivative work under copyright law: that is to say, a work containing the Program or a portion of it, either verbatim or with modifications and/or translated into another language. (Hereinafter, translation is included without limitation in the term "modification".) Each licensee is addressed as "you".

Activities other than copying, distribution and modification are not covered by this License; they are outside its scope. The act of running the Program is not restricted, and the output from the Program is covered only if its contents constitute a work based on the Program (independent of having been made by running the Program). Whether that is true depends on what the Program does.

1. You may copy and distribute verbatim copies of the Program's source code as you receive it, in any medium, provided that you conspicuously and appropriately publish on each copy an appropriate copyright notice and disclaimer of warranty; keep intact all the notices that refer to this License and to the absence of any warranty; and give any other recipients of the Program a copy of this License along with the Program.

You may charge a fee for the physical act of transferring a copy, and you may at your option offer warranty protection in exchange for a fee.

2. You may modify your copy or copies of the Program or any portion of it, thus forming a work based on the Program, and copy and distribute such modifications or work under the terms of Section 1 above, provided that you also meet all of these conditions:

a) You must cause the modified files to carry prominent notices stating that you changed the files and the date of any change.

b) You must cause any work that you distribute or publish, that in whole or in part contains or is derived from the Program or any part thereof, to be licensed as a whole at no charge to all third parties under the terms of this License.

c) If the modified program normally reads commands interactively when run, you must cause it, when started running for such interactive use in the most ordinary way, to print or display an announcement including an appropriate copyright notice and a notice that there is no warranty (or else, saying that you provide a warranty) and that users may redistribute the program under these conditions, and telling the user how to view a copy of this License. (Exception: if the Program itself is interactive but does not normally print such an announcement, your work based on the Program is not required to print an announcement.)

These requirements apply to the modified work as a whole. If identifiable sections of that work are not derived from the Program, and can be reasonably considered independent and separate works in themselves, then this License, and its terms, do not apply to those sections when you distribute them as separate works. But when you distribute the same sections as part of a whole which is a work based on the Program, the distribution of the whole must be on the terms of this License, whose permissions for other licensees extend to the entire whole, and thus to each and every part regardless of who wrote it.

Thus, it is not the intent of this section to claim rights or contest your rights to work written entirely by you; rather, the intent is to exercise the right to control the distribution of derivative or collective works based on the Program.

In addition, mere aggregation of another work not based on the Program with the Program (or with a work based on the Program) on a volume of a storage or distribution medium does not bring the other work under the scope of this License.

3. You may copy and distribute the Program (or a work based on it, under Section 2) in object code or executable form under the terms of Sections 1 and 2 above provided that you also do one of the following:

a) Accompany it with the complete corresponding machine-readable source code, which must be distributed under the terms of Sections 1 and 2 above on a medium customarily used for software interchange; or,

b) Accompany it with a written offer, valid for at least three years, to give any third party, for a charge no more than your cost of physically performing source distribution, a complete machine-readable copy of the corresponding source code, to be distributed under the terms of Sections 1 and 2 above on a medium customarily used for software interchange; or,

c) Accompany it with the information you received as to the offer to distribute corresponding source code. (This alternative is allowed only for noncommercial distribution and only if you received the program in object code or executable form with such an offer, in accord with Subsection b above.)

The source code for a work means the preferred form of the work for making modifications to it. For an executable work, complete source code means all the source code for all modules it contains, plus any associated interface definition files, plus the scripts used to control compilation and installation of the executable. However, as a special exception, the source code distributed need not include anything that is normally distributed (in either source or binary form) with the major components (compiler, kernel, and so on) of the operating system on which the executable runs, unless that component itself accompanies the executable.

If distribution of executable or object code is made by offering access to copy from a designated place, then offering equivalent access to copy the source code from the same place counts as distribution of the source code, even though third parties are not compelled to copy the source along with the object code.

4. You may not copy, modify, sublicense, or distribute the Program except as expressly provided under this License. Any attempt otherwise to copy, modify, sublicense or distribute the Program is void, and will automatically terminate your rights under this License. However, parties who have received copies, or rights, from you under this License will not have their licenses terminated so long as such parties remain in full compliance.

5. You are not required to accept this License, since you have not signed it. However, nothing else grants you permission to modify or distribute the Program or its derivative works. These actions are prohibited by law if you do not accept this License. Therefore, by modifying or distributing the Program (or any work based on the Program), you indicate your acceptance of this License to do so, and all its terms and conditions for copying, distributing or modifying the Program or works based on it.

6. Each time you redistribute the Program (or any work based on the Program), the recipient automatically receives a license from the original licensor to copy, distribute or modify the Program subject to these terms and conditions. You may not impose any further restrictions on the recipients' exercise of the rights granted herein. You are not responsible for enforcing compliance by third parties to this License.

7. If, as a consequence of a court judgment or allegation of patent infringement or for any other reason (not limited to patent issues), conditions are imposed on you (whether by court order, agreement or otherwise) that contradict the conditions of this License, they do not excuse you from the conditions of this License. If you cannot distribute so as to satisfy simultaneously your obligations under this License and any other pertinent obligations, then as a consequence you may not distribute the Program at all. For example, if a patent license would not permit royalty-free redistribution of the Program by all those who receive copies directly or indirectly through you, then the only way you could satisfy both it and this License would be to refrain entirely from distribution of the Program.

If any portion of this section is held invalid or unenforceable under any particular circumstance, the balance of the section is intended to apply and the section as a whole is intended to apply in other circumstances.

It is not the purpose of this section to induce you to infringe any patents or other property right claims or to contest validity of any such claims; this section has the sole purpose of protecting the integrity of the free software distribution system, which is implemented by public license practices. Many people have made generous contributions to the wide range of software distributed through that system in reliance on consistent application of that system; it is up to the author/donor to decide if he or she is willing to distribute software through any other system and a licensee cannot impose that choice.

This section is intended to make thoroughly clear what is believed to be a consequence of the rest of this License.

8. If the distribution and/or use of the Program is restricted in certain countries either by patents or by copyrighted interfaces, the original copyright holder who places the Program under this License may add an explicit geographical distribution limitation excluding those countries, so that distribution is permitted only in or among countries not thus excluded. In such case, this License incorporates the limitation as if written in the body of this License.

9. The Free Software Foundation may publish revised and/or new versions of the General Public License from time to time. Such new versions will be similar in spirit to the present version, but may differ in detail to address new problems or concerns.

Each version is given a distinguishing version number. If the Program specifies a version number of this License which applies to it and "any later version", you have the option of following the terms and conditions either of that version or of any later version published by the Free Software Foundation. If the Program does not specify a version number of this License, you may choose any version ever published by the Free Software Foundation.

10. If you wish to incorporate parts of the Program into other free programs whose distribution conditions are different, write to the author to ask for permission. For software which is copyrighted by the Free Software Foundation, write to the Free Software Foundation; we sometimes make exceptions for this. Our

decision will be guided by the two goals of preserving the free status of all derivatives of our free software and of promoting the sharing and reuse of software generally.

NO WARRANTY

11. BECAUSE THE PROGRAM IS LICENSED FREE OF CHARGE, THERE IS NO WARRANTY FOR THE PROGRAM, TO THE EXTENT PERMITTED BY APPLICABLE LAW. EXCEPT WHEN OTHERWISE STATED IN WRITING THE COPYRIGHT HOLDERS AND/OR OTHER PARTIES PROVIDE THE PROGRAM "AS IS" WITHOUT WARRANTY OF ANY KIND, EITHER EXPRESSED OR IMPLIED, INCLUDING, BUT NOT LIMITED TO, THE IMPLIED WARRANTIES OF MERCHANTABILITY AND FITNESS FOR A PARTICULAR PURPOSE. THE ENTIRE RISK AS TO THE QUALITY AND PERFORMANCE OF THE PROGRAM IS WITH YOU. SHOULD THE PROGRAM PROVE DEFECTIVE, YOU ASSUME THE COST OF ALL NECESSARY SERVICING, REPAIR OR CORRECTION.

12. IN NO EVENT UNLESS REQUIRED BY APPLICABLE LAW OR AGREED TO IN WRITING WILL ANY COPYRIGHT HOLDER, OR ANY OTHER PARTY WHO MAY MODIFY AND/OR REDISTRIBUTE THE PROGRAM AS PERMITTED ABOVE, BE LIABLE TO YOU FOR DAMAGES, INCLUDING ANY GENERAL, SPECIAL, INCIDENTAL OR CONSEQUENTIAL DAMAGES ARISING OUT OF THE USE OR INABILITY TO USE THE PROGRAM (INCLUDING BUT NOT LIMITED TO LOSS OF DATA OR DATA BEING RENDERED INACCURATE OR LOSSES SUSTAINED BY YOU OR THIRD PARTIES OR A FAILURE OF THE PROGRAM TO OPERATE WITH ANY OTHER PROGRAMS), EVEN IF SUCH HOLDER OR OTHER PARTY HAS BEEN ADVISED OF THE POSSIBILITY OF SUCH DAMAGES.

END OF TERMS AND CONDITIONS

How to Apply These Terms to Your New Programs

If you develop a new program, and you want it to be of the greatest possible use to the public, the best way to achieve this is to make it free software which everyone can redistribute and change under these terms.

To do so, attach the following notices to the program. It is safest to attach them to the start of each source file to most effectively convey the exclusion of warranty; and each file should have at least the "copyright" line and a pointer to where the full notice is found.

```
<one line to give the program's name and a brief idea of what it does.>
Copyright (C) <year> <name of author>
```

This program is free software; you can redistribute it and/or modify it under the terms of the GNU General Public License as published by the Free Software Foundation; either version 2 of the License, or (at your option) any later version.

This program is distributed in the hope that it will be useful, but WITHOUT ANY WARRANTY; without even the implied warranty of MERCHANTABILITY or FITNESS FOR A PARTICULAR PURPOSE. See the GNU General Public License for more details.

You should have received a copy of the GNU General Public License along with this program; if not, write to the Free Software Foundation, Inc., 51 Franklin Street, Fifth Floor, Boston, MA 02110-1301 USA

Also add information on how to contact you by electronic and paper mail.

If the program is interactive, make it output a short notice like this when it starts in an interactive mode:

```
Gnomovision version 69, Copyright (C) year name of author Gnomovision
comes with ABSOLUTELY NO WARRANTY; for details type `show w'. This is free
software, and you are welcome to redistribute it under certain conditions;
type `show c' for details.
```

The hypothetical commands `show w` and `show c` should show the appropriate parts of the General Public License. Of course, the commands you use may be called something other than `show w` and `show c`; they could even be mouse-clicks or menu items--whatever suits your program.

You should also get your employer (if you work as a programmer) or your school, if any, to sign a "copyright disclaimer" for the program, if necessary. Here is a sample; alter the names:

```
Yoyodyne, Inc., hereby disclaims all copyright interest in the program
`Gnomovision' (which makes passes at compilers) written by James Hacker.
```

```
<signature of Ty Coon>, 1 April 1989    Ty Coon, President of Vice
```

This General Public License does not permit incorporating your program into proprietary programs. If your program is a subroutine library, you may consider it more useful to permit linking proprietary applications with the library. If this is what you want to do, use the GNU Library General Public License instead of this License.

xz 5.0.3

XZ Utils Licensing =====

Different licenses apply to different files in this package. Here is a rough summary of which licenses apply to which parts of this package (but check the individual files to be sure!):

- liblzma is in the public domain.
- xz, xzdec, and lzmdec command line tools are in the public domain unless GNU getopt_long had to be compiled and linked in from the lib directory. The getopt_long code is under GNU LGPLv2.1+.
- The scripts to grep, diff, and view compressed files have been adapted from gzip. These scripts and their documentation are under GNU GPLv2+.
- All the documentation in the doc directory and most of the XZ Utils specific documentation files in other directories are in the public domain.
- Translated messages are in the public domain.
- The build system contains public domain files, and files that are under GNU GPLv2+ or GNU GPLv3+. None of these files end up in the binaries being built.
- Test files and test code in the tests directory, and debugging utilities in the debug directory are in the public domain.
- The extra directory may contain public domain files, and files that are under various free software licenses.

You can do whatever you want with the files that have been put into the public domain. If you find public domain legally problematic, take the previous sentence as a license grant. If you still find the lack of copyright legally problematic, you have too many lawyers.

As usual, this software is provided "as is", without any warranty.

If you copy significant amounts of public domain code from XZ Utils into your project, acknowledging this somewhere in your software is polite (especially if it is proprietary, non-free software), but naturally it is not legally required. Here is an example of a good notice to put into "about box" or into documentation:

This software includes code from XZ Utils <<http://tukaani.org/xz/>>.

The following license texts are included in the following files: -
COPYING.LGPLv2.1: GNU Lesser General Public License version 2.1 -
COPYING.GPLv2: GNU General Public License version 2 - COPYING.GPLv3: GNU
General Public License version 3

Note that the toolchain (compiler, linker etc.) may add some code pieces that are copyrighted. Thus, it is possible that e.g. liblzma binary wouldn't actually be in the public domain in its entirety even though it contains no copyrighted code from the XZ Utils source package.

If you have questions, don't hesitate to ask the author(s) for more information.

Anmerkung: The software included in this product contains copyrighted software that is licensed under the GPL and LGPL. You may obtain the complete corresponding source code from us for a period of three years after our last shipment of this product by sending a request to:

Hirschmann Automation and Control GmbH
3rd Level Support
Stuttgarter Str. 45-51
72654 Neckartenzlingen
Germany

A.13 Abkürzungen

ACA	AutoConfiguration Adapter
ACL	Access Control List
BOOTP	Bootstrap Protocol
CLI	Command Line Interface
DHCP	Dynamic Host Configuration Protocol
FDB	Forwarding Database
GUI	Grafische Benutzeroberfläche
HTTP	Hypertext Transfer Protocol
HTTPS	Hypertext Transfer Protocol Secure
ICMP	Internet Control Message Protocol
IEEE	Institute of Electrical and Electronics Engineers
IP	Internet Protocol
LED	Light Emitting Diode
LLDP	Link Layer Discovery Protocol
LWL	Lichtwellenleiter
MAC	Media Access Control
MIB	Management Information Base
MRP	Media Redundancy Protocol
MSTP	Multiple Spanning Tree Protocol
NMS	Netzmanagementsystem
NTP	Network Time Protocol
PC	Personal Computer
PTP	Precision Time Protocol
QoS	Quality of Service
RFC	Request For Comment
RM	Redundancy Manager
RSTP	Rapid Spanning Tree Protocol
SCP	Secure Copy
SFP	Small Form-factor Pluggable
SFTP	SSH File Transfer Protocol
SNMP	Simple Network Management Protocol
SNTP	Simple Network Time Protocol
TCP	Transmission Control Protocol
TFTP	Trivial File Transfer Protocol
TP	Twisted Pair
UDP	User Datagram Protocol
URL	Uniform Resource Locator
UTC	Coordinated Universal Time
VLAN	Virtual Local Area Network

B Leserkritik

Wie denken Sie über dieses Handbuch? Wir sind stets bemüht, in unseren Handbüchern das betreffende Produkt vollständig zu beschreiben und wichtiges Hintergrundwissen zu vermitteln, damit der Einsatz dieses Produkts problemlos erfolgen kann. Ihre Kommentare und Anregungen unterstützen uns, die Qualität und den Informationsgrad dieser Dokumentation noch zu steigern.

Ihre Beurteilung für dieses Handbuch:

	sehr gut	gut	befriedigend	mäßig	schlecht
Exakte Beschreibung	<input type="radio"/>	<input type="radio"/>	<input type="radio"/>	<input type="radio"/>	<input type="radio"/>
Lesbarkeit	<input type="radio"/>	<input type="radio"/>	<input type="radio"/>	<input type="radio"/>	<input type="radio"/>
Verständlichkeit	<input type="radio"/>	<input type="radio"/>	<input type="radio"/>	<input type="radio"/>	<input type="radio"/>
Beispiele	<input type="radio"/>	<input type="radio"/>	<input type="radio"/>	<input type="radio"/>	<input type="radio"/>
Aufbau	<input type="radio"/>	<input type="radio"/>	<input type="radio"/>	<input type="radio"/>	<input type="radio"/>
Vollständigkeit	<input type="radio"/>	<input type="radio"/>	<input type="radio"/>	<input type="radio"/>	<input type="radio"/>
Grafiken	<input type="radio"/>	<input type="radio"/>	<input type="radio"/>	<input type="radio"/>	<input type="radio"/>
Zeichnungen	<input type="radio"/>	<input type="radio"/>	<input type="radio"/>	<input type="radio"/>	<input type="radio"/>
Tabellen	<input type="radio"/>	<input type="radio"/>	<input type="radio"/>	<input type="radio"/>	<input type="radio"/>

Haben Sie in diesem Handbuch Fehler entdeckt?
 Wenn ja, welche auf welcher Seite?

Leserkritik

Anregungen, Verbesserungsvorschläge, Ergänzungsvorschläge:

Allgemeine Kommentare:

Absender:

Firma / Abteilung:

Name / Telefonnummer:

Straße:

PLZ / Ort:

E-Mail:

Datum / Unterschrift:

Sehr geehrter Anwender,

Bitte schicken Sie dieses Blatt ausgefüllt zurück

- ▶ als Fax an die Nummer +49 (0)7127 14-1600 oder
- ▶ per Post an

Hirschmann Automation and Control GmbH
Abteilung 01RD-NT
Stuttgarter Str. 45-51
72654 Neckartenzlingen

C Weitere Unterstützung

Technische Fragen

Bei technischen Fragen wenden Sie sich bitte an den Hirschmann-Vertragspartner in Ihrer Nähe oder direkt an Hirschmann.

Die Adressen unserer Vertragspartner finden Sie im Internet unter <http://www.hirschmann.com>.

Eine Liste von Telefonnummern und E-Mail-Adressen für direkten technischen Support durch Hirschmann finden Sie unter <https://hirschmann-support.belden.com>.

Sie finden auf dieser Website außerdem eine kostenfreie Wissensdatenbank sowie einen Download-Bereich für Software.

Hirschmann Competence Center

Das Hirschmann Competence Center mit dem kompletten Spektrum innovativer Dienstleistungen hat vor den Wettbewerbern gleich dreifach die Nase vorn:

- ▶ Das Consulting umfasst die gesamte technische Beratung von der Systembewertung über die Netzplanung bis hin zur Projektierung.
- ▶ Das Training bietet Grundlagenvermittlung, Produkteinweisung und Anwenderschulung mit Zertifizierung.
Das aktuelle Schulungsangebot zu Technologie und Produkten finden Sie unter <http://www.hicomcenter.com>.
- ▶ Der Support reicht von der Inbetriebnahme über den Bereitschaftsservice bis zu Wartungskonzepten.

Mit dem Hirschmann Competence Center entscheiden Sie sich in jedem Fall gegen jeglichen Kompromiss. Das kundenindividuelle Angebot lässt Ihnen die Wahl, welche Komponenten Sie in Anspruch nehmen.

Internet:
<http://www.hicomcenter.com>



HIRSCHMANN

A **BELDEN** BRAND