



**HIRSCHMANN**

A **BELDEN** BRAND

# User Manual

## Installation

IP65/67/69K Switch

OCTOPUS 8TX-EEC

OCTOPUS 8TX PoE-EEC

OCTOPUS 8TX-EEC-M

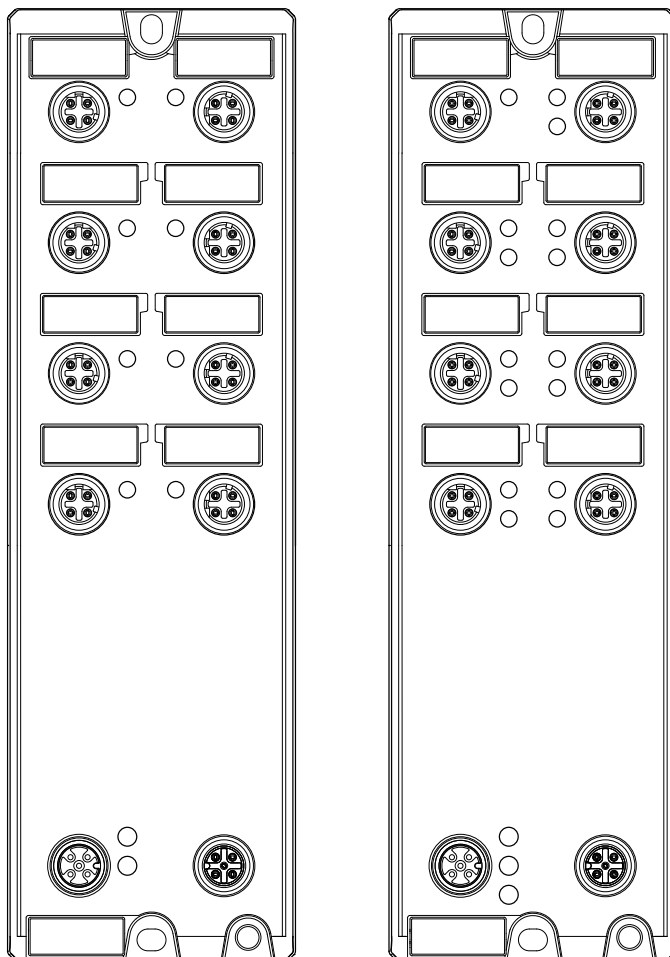

The naming of copyrighted trademarks in this manual, even when not specially indicated, should not be taken to mean that these names may be considered as free in the sense of the trademark and tradename protection law and hence that they may be freely used by anyone.

© 2023 Hirschmann Automation and Control GmbH

Manuals and software are protected by copyright. All rights reserved. The copying, reproduction, translation, conversion into any electronic medium or machine scannable form is not permitted, either in whole or in part. An exception is the preparation of a backup copy of the software for your own use.

The performance features described here are binding only if they have been expressly agreed when the contract was made. This document was produced by Hirschmann Automation and Control GmbH according to the best of the company's knowledge. Hirschmann reserves the right to change the contents of this document without prior notice. Hirschmann can give no guarantee in respect of the correctness or accuracy of the information in this document.

Hirschmann can accept no responsibility for damages, resulting from the use of the network components or the associated operating software. In addition, we refer to the conditions of use specified in the license contract.

You can get the latest version of this manual on the Internet at:  
<https://www.doc.hirschmann.com>

Hirschmann Automation and Control GmbH  
Stuttgarter Str. 45-51  
72654 Neckartenzlingen  
Germany

# Contents

Important information	5
Safety instructions	7
About this Manual	18
Key	19
1    Description	20
1.1    General device description	20
1.2    Device view	21
1.2.1    OCTOPUS 8TX-EEC	21
1.2.2    OCTOPUS 8TX PoE-EEC	22
1.2.3    OCTOPUS 8TX-EEC-M	24
1.3    Power supply	25
1.4    Ethernet ports	25
1.4.1    10/100 Mbit/s twisted pair port	25
1.4.2    10/100 Mbit/s PoE port	26
1.4.3    Pin assignment OCTOPUS 8TX-EEC and OCTOPUS 8TX-EEC-M	26
1.4.4    Pin assignment OCTOPUS 8TX PoE-EEC	26
1.5    Display elements	27
1.5.1    Device status	27
1.5.2    Port Status	30
1.6    Management interfaces	33
1.6.1    ACA-M12 interface	33
1.6.2    ACA22-C interface	34
1.6.3    Signal contact	35
2    Installation	37
2.1    Checking the package contents	37
2.2    Installing and grounding the device	37
2.2.1    Mounting on a flat surface	37
2.2.2    Grounding the device	38
2.3    Connecting the power supply and the signal contact lines	39

2.3.1	Connecting the signal contact (optional)	39
2.3.2	Pin assignment OCTOPUS 8TX-EEC	40
2.3.3	Pin assignment OCTOPUS 8TX PoE-EEC	40
2.3.4	Pin assignment OCTOPUS 8TX-EEC-M	40
2.4	Operating the device	40
2.5	Connecting data cables	41
2.6	Configuration (optional)	42
2.6.1	Configuration readout	48
3	Making basic settings	49
3.1	First login (Password change)	50
4	Monitoring the ambient air temperature	51
5	Maintenance and service	52
6	Disassembly	53
7	Technical data	54
7.1	General technical data	54
7.2	Dimension drawings	58
7.3	EMC and immunity	61
7.4	Network range	61
7.5	Power consumption/power output	62
7.6	Signal contact	62
8	Scope of delivery, order numbers and accessories	63
9	Underlying technical standards	65
A	Further support	66
B	Open Source Software used in the product	67

# Important information

**Note:** Read these instructions carefully, and familiarize yourself with the device before trying to install, operate, or maintain it. The following notes may appear throughout this documentation or on the device. These notes warn of potential hazards or call attention to information that clarifies or simplifies a procedure.

## ■ Symbol explanation



This is a general warning symbol. This symbol alerts you to potential personal injury hazards. Observe all safety notes that follow this symbol to avoid possible injury or death.



If this symbol is displayed in addition to a safety instruction of the type “Danger” or “Warning”, it means that there is a danger of electric shock and failure to observe the instructions will inevitably result in injury.



This symbol indicates the danger of hot surfaces on the device. In connection with safety instructions, non-observance of the instructions will inevitably result in injuries.



## DANGER

**DANGER** draws attention to an immediately dangerous situation, which will **inevitably** result in a serious or fatal accident if not observed.



## WARNING

**WARNING** indicates a potentially hazardous situation which, if not avoided, **could** result in death or serious injury.



## CAUTION

**CAUTION** indicates a possible danger which, if not avoided, **may** result in minor injuries.

# NOTICE

**NOTICE** provides information about procedures that do not involve the risk of injury.

# Safety instructions



## WARNING

### UNCONTROLLED MACHINE ACTIONS

To avoid uncontrolled machine actions caused by data loss, configure all the data transmission devices individually.

Before you start any machine which is controlled via data transmission, be sure to complete the configuration of all data transmission devices.

**Failure to follow these instructions can result in death, serious injury, or equipment damage.**

#### ■ General safety instructions

You operate this device with electricity. Improper usage of the device entails the risk of physical injury or significant property damage. The proper and safe operation of this device depends on proper handling during transportation, proper storage and installation, and careful operation and maintenance procedures.

- Before connecting any cable, read this document, and the safety instructions and warnings.
- Operate the device with undamaged components exclusively.
- The device is free of any service components. In case of a damaged or malfunctioning device, turn off the supply voltage and return the device to Hirschmann for inspection.

#### ■ Certified usage

- Use the product only for the application cases described in the Hirschmann product information, including this manual.
- Operate the product only according to the technical specifications. [See "Technical data" on page 54.](#)
- Connect to the product only components suitable for the requirements of the specific application case.

Operational environment:

- ▶ On the inside of vehicles
- ▶ On the inside of buildings

## ■ Installation site requirements

- When you are selecting the installation location, make sure you observe the climatic threshold values specified in the technical data.
- Operate the device only at the specified ambient temperature (temperature of the ambient air at a distance of 5 cm (2 in) from the device) and at the specified relative humidity.
- Use the device in an environment with a maximum pollution degree that complies with the specifications in the technical data.

**Note:** Operation of the device in high humidity or condensing atmospheres is exclusively allowed when using recommended accessories with IP65/67/69K rating.

## ■ Strain relief

**Note:** If the strain relief is insufficient, there is a potential risk of torsion, contact problems and creeping interruptions.

- Relieve the connection points of cables and lines from mechanical stress.
- Design strain reliefs in such a way that they help prevent any mechanical damage to cables, wires or conductors caused by external influences or their own weight.
- To help prevent damage to device connections, connectors and cables, follow the instructions for proper installation in accordance with DIN VDE 0100-520:2013-06, sections 522.6, 522.7 and 522.13.

## ■ Device casing

- At ambient air temperatures  $> +60\text{ °C}$  ( $+140\text{ °F}$ ):  
The surfaces of the device housing may become hot. Avoid touching the device while it is operating.

## ■ Qualification requirements for personnel

- Only allow qualified personnel to work on the device.

Qualified personnel have the following characteristics:

- ▶ Qualified personnel are properly trained. Training as well as practical knowledge and experience make up their qualifications. This is the prerequisite for grounding and labeling circuits, devices, and systems in accordance with current standards in safety technology.
- ▶ Qualified personnel are aware of the dangers that exist in their work.
- ▶ Qualified personnel are familiar with appropriate measures against these hazards in order to reduce the risk for themselves and others.
- ▶ Qualified personnel receive training on a regular basis.



- National and international safety regulations
  - Verify that the electrical installation meets local or nationally applicable safety regulations.
  
- Shielding ground

The overall shield of a connected shielded twisted pair cable is connected to the ground connection on the metal housing as a conductor.

  - Beware of possible short circuits when connecting a cable section with conductive shielding braiding.

- Requirements for connecting electrical wires  
Before connecting the electrical wires, **always** verify that the requirements listed are complied with.

### General requirements for connecting electrical wires

#### The following requirements apply without restrictions:

- ▶ The electrical wires are voltage-free.
- ▶ The cables used are permitted for the temperature range of the application case.
- ▶ Ground the device via the ground screw.  
Disconnect the grounding only after disconnecting all other cables.
- ▶ For OCTOPUS 8TX-EEC and OCTOPUS 8TX PoE-EEC:  
Exclusively use 60/75 °C (140/167 °F) or 75 °C (167 °F) copper (Cu) wire.
- ▶ For OCTOPUS 8TX-EEC-M:  
Only use cables that are suitable for a temperature 20 °C (36 °F) higher than the maximum ambient air temperature at which the device is used. Only use copper wire.
- ▶ The power supply cable to be connected is suitable for ambient air temperature of at least 212 °F (100 °C).
- ▶ The power supply complies with the requirements for a safety extra-low voltage (SELV) according to IEC 60950-1 or ES1 according to IEC/EN 62368-1.
- ▶ Relevant for North America:  
Use a UL certified cable with a suitable evaluation to connect the devices (CYJV or PVVA).
- ▶ The external circuits intended to be connected to this device shall be separated from the mains supply or hazardous live voltage by reinforced or double insulation and meet the requirements of SELV/PELV (Class III) circuits according to UL/CSA/IEC 61010-1, UL/CSA/IEC 61010-2-201.

### Requirements for connecting the supply voltage

#### The following requirements apply without restrictions:

All of the following requirements are complied with:

- ▶ The supply voltage corresponds to the voltage specified on the type plate of the device.
- ▶ The power supply conforms to overvoltage category I or II.
- ▶ The power supply has an easily accessible disconnecting device (for example a switch or a plug). This disconnecting device is clearly identified. So in the case of an emergency, it is clear which disconnecting device belongs to which power supply cable.
- ▶ The power supply cable is suitable for the voltage, the current and the physical load.  
Hirschmann recommends a conductor cross section of 0.5 mm<sup>2</sup> to 0.75 mm<sup>2</sup> (AWG20 up to AWG18).

#### The following requirements apply alternatively:

Relevant when the device is supplied via 1 voltage input:

- |               |   |
|---------------|---|
| Alternative 1 | The power supply complies with the requirements for a limited power source (LPS) according to IEC 60950-1 or ES1 + PS2 according to IEC/EN 62368-1. |
| Alternative 2 | Relevant for North America:<br>The power supply complies with the requirements according to NEC Class 2.  |

## Requirements for connecting the supply voltage

- Alternative 3 **All** of the following requirements are complied with:
- ▶ The power supply complies with the requirements for a safety extra-low voltage (SELV) according to IEC 60950-1 or ES1 according to IEC/EN 62368-1.
  - ▶ Install a fuse suitable for DC voltage in the plus conductor of the power supply.  
Connect the minus conductor to the ground potential. If the minus conductor is not connected to the ground potential, also install an external fuse in the minus conductor.  
Regarding the properties of this fuse:  
[See "General technical data" on page 54.](#)

Relevant when the device is supplied via 2 voltage inputs:

- Alternative 1 The **total** power supply complies with the requirements for a limited power source (LPS) according to IEC 60950-1 or IEC/EN 62368-1.
- Alternative 2 Relevant for North America:  
The **total** voltage supply complies with the requirements as per NEC Class 2.
- Alternative 3 **All** of the following requirements are complied with:
- ▶ The power supply complies with the requirements for a safety extra-low voltage (SELV) according to IEC 60950-1 or ES1 according to IEC/EN 62368-1.
  - ▶ In both voltage inputs, install a fuse suitable for DC voltage in the plus conductor of the power supply.  
In both voltage inputs, connect the minus conductor to the ground potential. If the minus conductor is not connected to the ground potential, also install an external fuse in the minus conductor.  
Regarding the properties of this fuse:  
[See "General technical data" on page 54.](#)

- Relevant for use in explosion hazard areas (Hazardous Locations, Class I, Division 2)

This equipment is exclusively suitable for use in Class I, Division 2, Groups A, B, C, and D or non-hazardous locations.

**WARNING – EXPLOSION HAZARD – DO NOT DISCONNECT EQUIPMENT UNLESS POWER HAS BEEN SWITCHED OFF OR THE AREA IS KNOWN TO BE NON-HAZARDOUS.**





**WARNING - EXPLOSION HAZARD - SUBSTITUTION OF ANY COMPONENT MAY IMPAIR SUITABILITY FOR CLASS I, DIVISION 2.**

**Avertissement** - Risque d'explosion - Ne pas débrancher tant que le circuit est sous tension à moins que l'emplacement soit connu pour ne contenir aucune concentration de gaz inflammable.

**Avertissement** - Risque d'explosion - La substitution de tout composant peut rendre ce matériel incompatible pour une utilisation en classe I, division 2.

This device is an open-type device that is to be installed in an enclosure suitable for the environment.

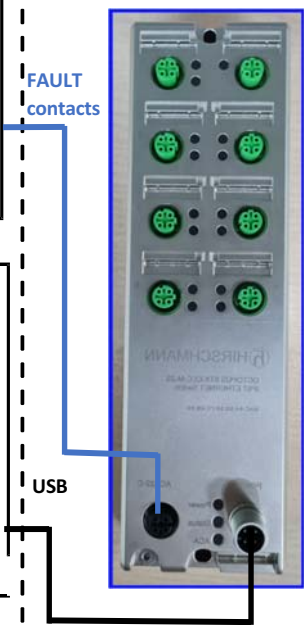
Exclusively use the device for the application cases specified by the manufacturer. Failure to follow these instructions can impair device protection.

<div style="text-align: center;">  <p>Ordinary Location, Non-Hazardous Area, non-explosive atmosphere</p> </div> <div style="border: 1px solid black; padding: 5px; margin-top: 10px;"> <p>Relay contacts: Equipment with non-incendive field wiring parameters. Polarity is not relevant. The relay terminals are dependent upon the following entity parameters:</p> <p><math>V_{max} \leq 30V</math>   <math>I_{max} \leq 90mA</math>   <math>C_i \leq 2nF</math>   <math>L_i \leq 1\mu H</math></p> </div> <div style="border: 1px solid black; padding: 5px; margin-top: 10px;"> <p>The ACA22-M12-C (EEC) storage medium is mechanically secured to prevent disconnection.</p> <p>A USB cable for configuration the device may exclusively be used in non-hazardous locations.</p> <p><b>WARNING!</b> Connection or disconnection in an explosive atmosphere could result in an explosion</p> </div>	<div style="text-align: center;">  <p>Explosive Atmosphere Class 1 Division 2 Group A, B, C, D Hazardous Location</p> </div> <div style="text-align: center; margin-top: 20px;">  </div>	
<p><b>For Use in Hazardous Locations Class I Division 2 Groups A, B, C, D:</b> Only allowed for Octopus 8TX-EEC-M model No's. which are individually labelled "FOR USE IN HAZARDOUS LOCATIONS"</p> <p><b>Nonincendive field wiring circuits must be wired in accordance with the National Electrical Code (NEC), NFPA 70, article 501. CEC, Appendix J, Annex J 18</b></p> <p><b>The earth conductor must be at least the same wire size (mm<sup>2</sup> or AWG) as the supply conductors.</b></p> <p><b>WARNING - EXPLOSION HAZARD – SUBSTITUTION OF ANY COMPONENTS MAY IMPAIR SUITABILITY FOR HAZARDOUS LOCATIONS OR EXPLOSIVE ATMOSPHERES.</b></p> <p><b>WARNING - EXPLOSION HAZARD - DO NOT DISCONNECT EQUIPMENT UNLESS POWER HAS BEEN SWITCHED OFF OR THE AREA IS KNOWN TO BE NON-HAZARDOUS.</b></p>		
<p>CONTROL DRAWING Octopus 8TX-EEC-M Series for Use in Hazardous Locations Class I Division 2, Groups A, B, C, D Locations</p>		
Rev.: 0	Doc.No.: 000247204DNR	
Page 1 of 2		

Capacitance and inductance of the field wiring from the nonincendive circuit to the associated apparatus shall be calculated and must be included in the system calculations as shown in Table 1. Cable capacitance,  $C_{cable}$ , plus nonincendive equipment capacitance,  $C_i$ , must be less than the marked capacitance,  $C_a$  (or  $C_o$ ), shown on any associated apparatus used. The same applies for inductance ( $L_{cable}$ ,  $L_i$  and  $L_a$  or  $L_o$ , respectively). Where the cable capacitance and inductance per foot are not known, the following values shall be used:  
 $C_{cable} = 60 \text{ pF/ft.}$ ,  $L_{cable} = 0.2 \text{ } \mu\text{H/ft.}$

**TABLE 1:**

<u>Nonincendive Equipment</u>		<u>Associated Apparatus</u>
$V_{max}$ (or $U_i$ )	$\geq$	$V_{oc}$ or $V_t$ (or $U_o$ )
$I_{max}$ (or $I_i$ )	$\geq$	$I_{sc}$ or $I_t$ (or $I_o$ )
$P_{max}$ (or $P_i$ )	$\geq$	$P_o$
$C_i + C_{cable}$	$\leq$	$C_a$ (or $C_o$ )
$L_i + L_{cable}$	$\leq$	$L_a$ (or $L_o$ )

Suitability for installation in particular applications is at the discretion of the Authority Having Jurisdiction (AHJ).

CONTROL DRAWING Octopus 8TX-EEC-M Series for Use  
in Hazardous Locations Class I Division 2, Groups A, B, C, D Locations



Rev.: 0

Doc.No.: 000247204DNR

Page 2 of 2

■ E marking

The labeled devices comply with the regulations contained in the following European directive(s):

**UN/ECE Regulation No. 10**

Uniform provisions concerning the approval of vehicles with regard to electromagnetic compatibility.

**UN/ECE Regulation No. 118**

Uniform technical prescriptions concerning the burning behaviour and/or the capability to repel fuel or lubricant of materials used in the construction of certain categories of motor vehicles.

The devices are suited for installation in vehicles according to the conditions of ECE Regulation No. 118.

Certified devices are marked with an E type approval indicator.

■ CE marking

The labeled devices comply with the regulations contained in the following European directive(s):

▶ **2011/65/EU and 2015/863/EU (RoHS)**

Directive of the European Parliament and of the Council on the restriction of the use of certain hazardous substances in electrical and electronic equipment.

▶ **2014/30/EU (EMC)**

Directive of the European Parliament and of the Council on the harmonisation of the laws of the Member States relating to electromagnetic compatibility.

In accordance with the above-named EU directive(s), the EU conformity declaration will be at the disposal of the relevant authorities at the following address:

Hirschmann Automation and Control GmbH  
Stuttgarter Str. 45-51  
72654 Neckartenzlingen  
Germany  
[www.hirschmann.com](http://www.hirschmann.com)

You find the EU conformity declaration as PDF file for downloading on the Internet at: <https://www.doc.hirschmann.com/certificates.html>

The device can be used in industrial environments.

- ▶ Interference immunity: EN 61000-6-2
- ▶ Emitted interference: EN 55032

The assembly guidelines provided in these instructions must be strictly adhered to in order to observe the EMC threshold values.

**Warning!** This is a class A device. This device can cause interference in living areas, and in this case the operator may be required to take appropriate measures.

## ■ UKCA marking

The labeled devices comply with the following UK regulations:

▶ **S.I. 2012 No. 3032**

Restriction of the Use of Certain Hazardous Substances in Electrical and Electronical Equipment Regulations

▶ **S.I. 2016 No. 1091**

Electromagnetic Compatibility Regulations



The UKCA conformity declaration will be available to the relevant authorities at the following address:

Belden UK Ltd.

1 The Technology Centre, Station Road  
Framlingham, IP13 9EZ, United Kingdom

You find the UKCA conformity declaration as PDF file for downloading on the Internet at: <https://www.doc.hirschmann.com/certificates.html>

The device can be used in industrial environments.

- ▶ Interference immunity: EN 61000-6-2
- ▶ Emitted interference: EN 55032

The assembly guidelines provided in these instructions must be strictly adhered to in order to observe the EMC threshold values.

**Warning!** This is a class A device. This device can cause interference in living areas, and in this case the operator may be required to take appropriate measures.



■ FCC note

**Supplier's Declaration of Conformity**  
**47 CFR § 2.1077 Compliance Information**

OCTOPUS 8TX-EEC

**U.S. Contact Information**

Belden – St. Louis  
1 N. Brentwood Blvd. 15th Floor  
St. Louis, Missouri 63105, United States  
Phone: 314.854.8000

This device complies with part 15 of the FCC Rules. Operation is subject to the following two conditions: (1) This device may not cause harmful interference, and (2) this device must accept any interference received, including interference that may cause undesired operation.

**Note:** This equipment has been tested and found to comply with the limits for a Class A digital device, pursuant to part 15 of the FCC Rules. These limits are designed to provide reasonable protection against harmful interference when the equipment is operated in a commercial environment. This equipment generates, uses, and can radiate radio frequency energy and, if not installed and used in accordance with the instruction manual, may cause harmful interference to radio communications. Operation of this equipment in a residential area is likely to cause harmful interference in which case the user will be required to correct the interference at his own expense.

■ Recycling note

After usage, this device must be disposed of properly as electronic waste, in accordance with the current disposal regulations of your county, state, and country.



# About this Manual

The “Installation” user manual contains a device description, safety instructions, a description of the display, and the other information that you need to install the device.

Documentation mentioned in the “User Manual Installation” that is not supplied with your device as a printout can be found as PDF files for downloading on the Internet at: <https://www.doc.hirschmann.com>

# Key

The symbols used in this manual have the following meanings:

	Listing
	Work step
	Subheading

# 1 Description

## 1.1 General device description

The device is designed for the special requirements of industrial automation. The device meets the relevant industry standards, provides very high operational reliability, even under extreme conditions, and also long-term reliability and flexibility.

The device allows you to set up switched Industrial Ethernet networks according to standard IEEE 802.3.

The device complies with the degrees of protection IP65/67/69K. To sustain the IP65/67/69K suitability for your device, exclusively use accessories with degree of protection IP65/67/69K. Seal all unused connections and ports with protection screws. To comply with IPX9K suitability, use metal protection screws and cover the rear side of the device.

The device works without a fan.

The voltage is supplied redundantly.

## 1.2 Device view

### 1.2.1 OCTOPUS 8TX-EEC

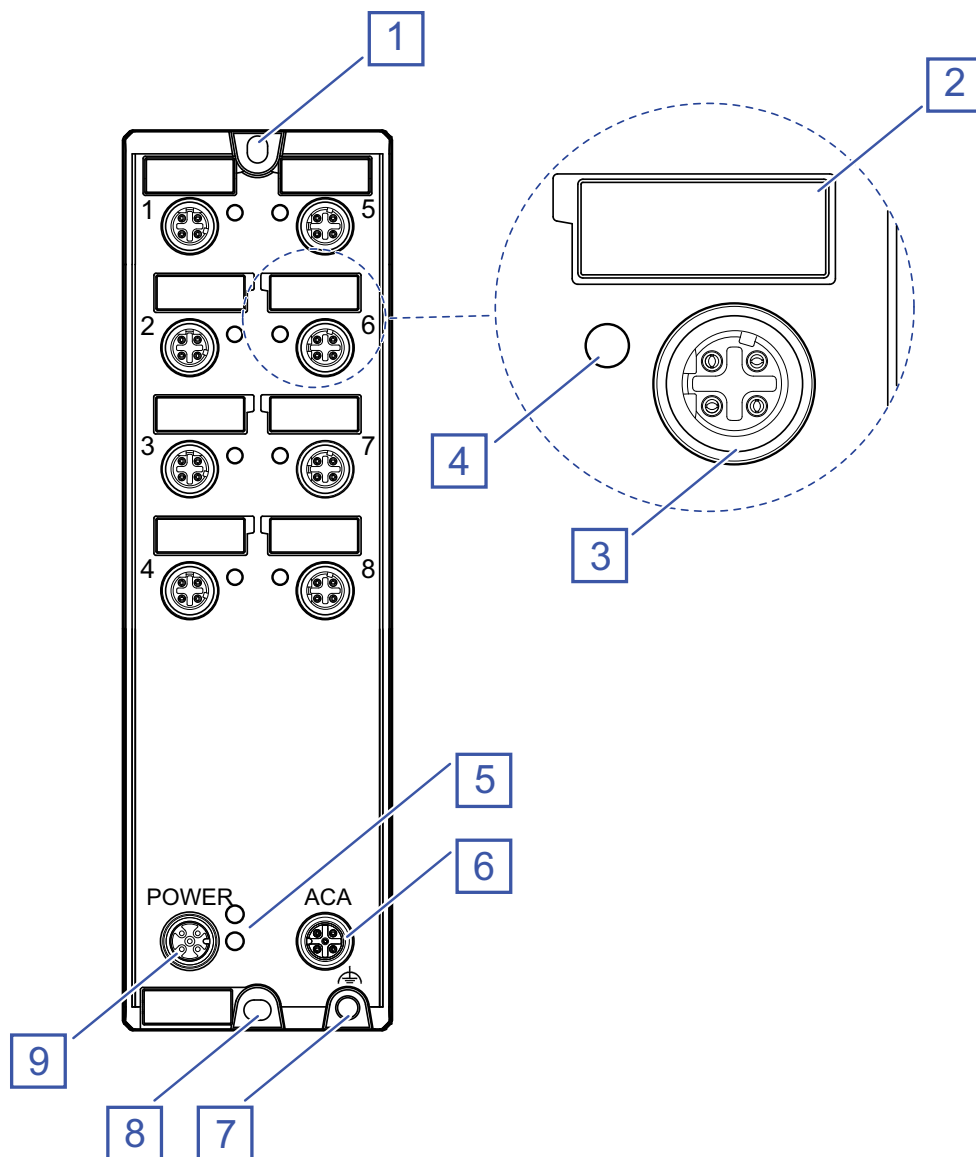

Item	Characteristic
1	Slot hole for mounting on a flat surface
2	8 × Indicator plate
3	8 × 4-pin, "D"-coded M12 socket for 10/100 Mbit/s twisted pair connections
4	8 × LED display elements for port status
5	LED display element for device status
6	M12 interface for the connection of ACA21-M12 (EEC) and ACA22-M12 (EEC)
7	Ground connection
8	Slot hole for mounting on a flat surface
9	Supply voltage connection

## 1.2.2 OCTOPUS 8TX PoE-EEC

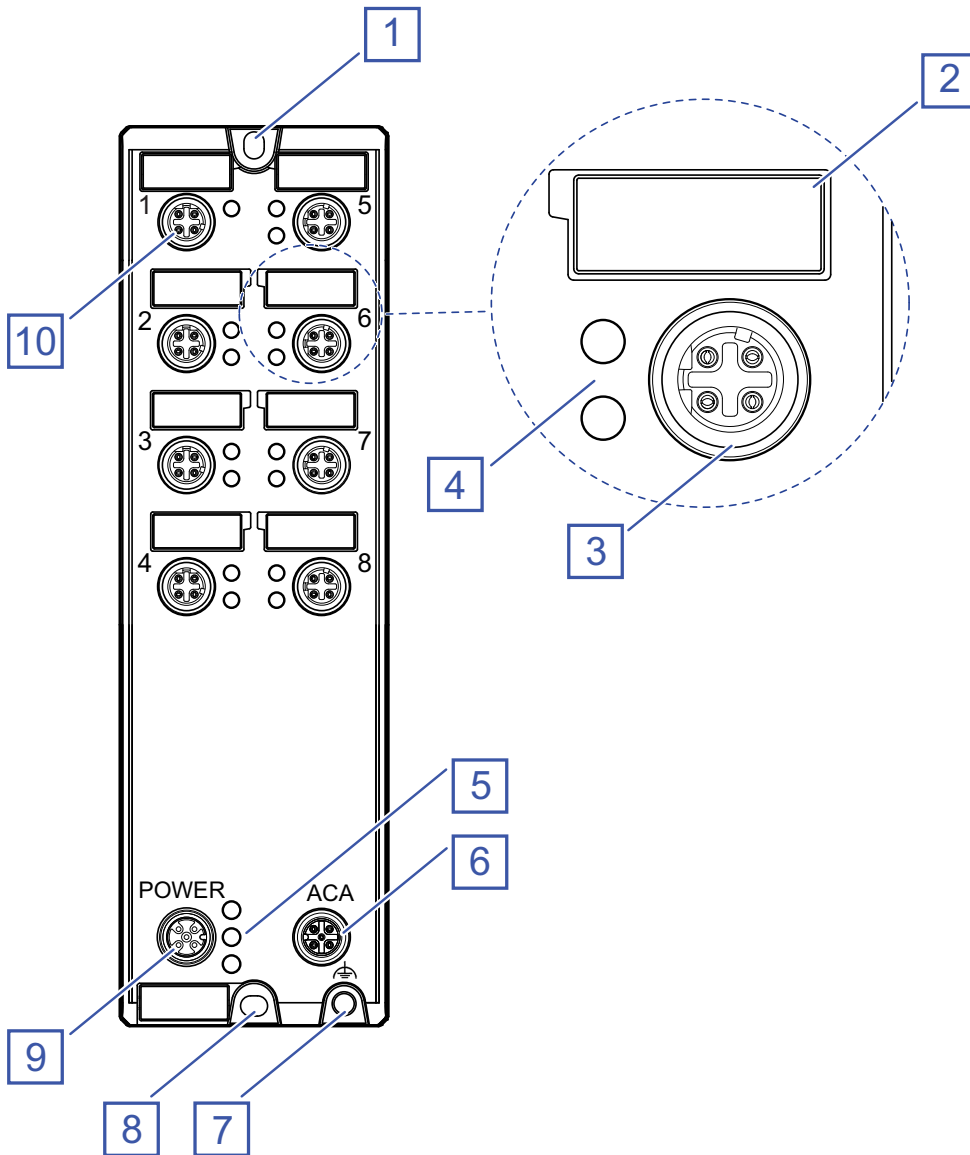

Item	Characteristic
1	Slot hole for mounting on a flat surface
2	8 × Indicator plate
3	7 × 4-pin, "D"-coded M12 socket for 10/100 Mbit/s twisted pair connections with PoE support
4	15 × LED display elements for port status PoE status
5	LED display element for device status
6	M12 interface for the connection of ACA21-M12 (EEC) and ACA22-M12 (EEC)
7	Ground connection
8	Slot hole for mounting on a flat surface
9	Supply voltage connection
10	4-pin, "D"-coded M12 socket for 10/100 Mbit/s twisted pair connections without PoE support

The device supports Power over Ethernet Plus in accordance with IEEE 802.3at (PoE+) and enables you to supply current to terminal devices such as IP phones via the twisted-pair cable.

The Power over Ethernet Plus function is activated both globally and on the PoE-capable ports on delivery.

You will recognize the PoE-capable ports from the printed PoE logo.

The voltage is supplied through the wire pairs transmitting the signal (phantom voltage). The individual ports are not electrically insulated from each other.

In accordance with IEEE 802.3af and IEEE 802.3at:

- ▶ Endpoint PSE
- ▶ Alternative A

### 1.2.3 OCTOPUS 8TX-EEC-M

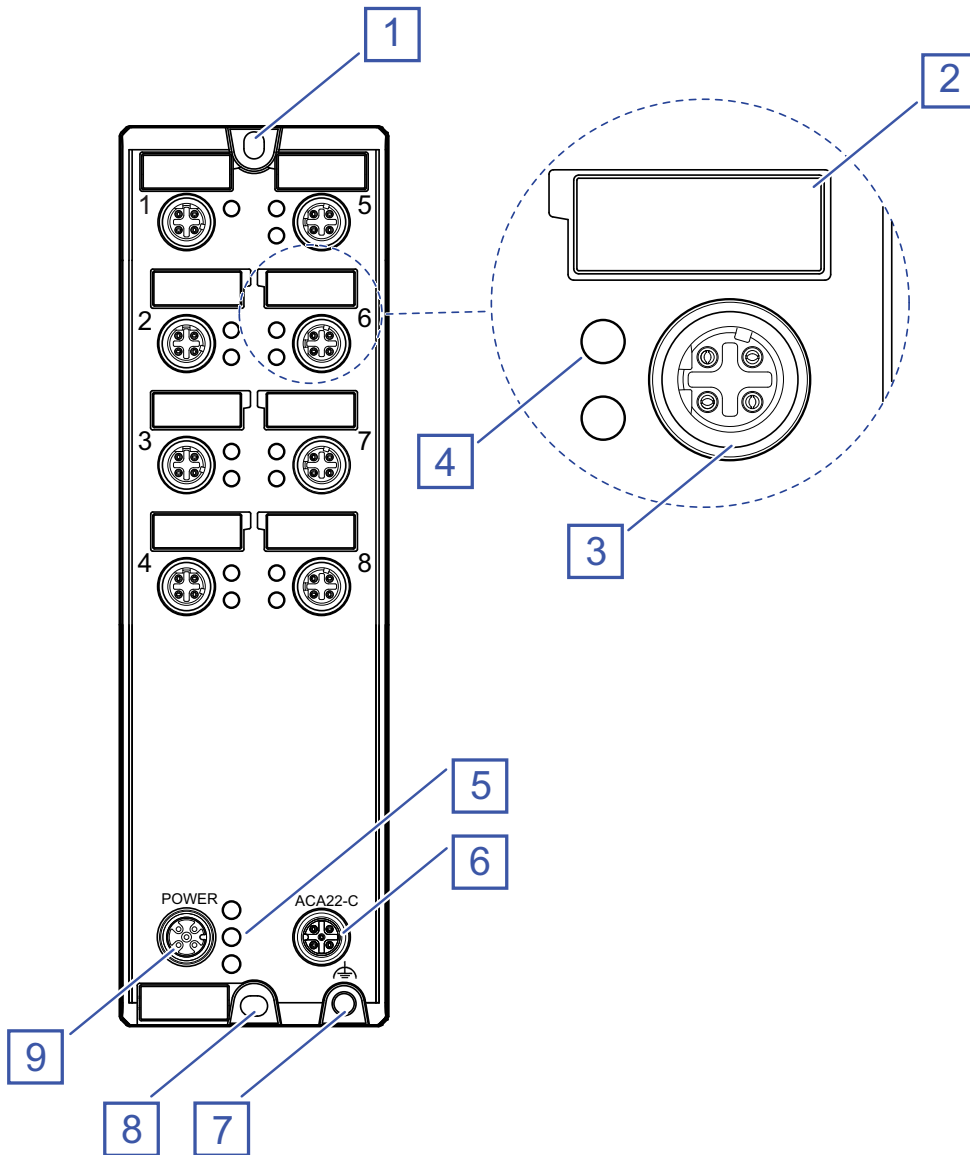

Item	Characteristic
1	Slot hole for mounting on a flat surface
2	8 × Indicator plate
3	8 × 4-pin, “D”-coded M12 socket for 10/100 Mbit/s twisted pair connections
4	8 × LED <sup>a</sup> Port status
5	LED display element for device status
6	M12 interface for the connection of ACA22-M12-C (EEC) or a USB configuration cable
7	Ground connection
8	Slot hole for mounting on a flat surface
9	Supply voltage connection and signal contact

- a. In the present hardware version, the lower port LEDs of the M12 ports are without function. The port status is displayed via the upper port LED.



## 1.3 Power supply

The supply voltage is connected by means of a 5-pin, "A"-coded M12 connector (e. g. ELWIK A 5012 PG7).

You will find more information here:

["Connecting the power supply and the signal contact lines" on page 39](#)

## 1.4 Ethernet ports

You can connect terminal devices and other segments at the ports of the device via twisted pair cables.

You find information on the pin assignments for making patch cables here:

- ▶ ["Pin assignment OCTOPUS 8TX-EEC and OCTOPUS 8TX-EEC-M" on page 26](#)
- ▶ ["Pin assignment OCTOPUS 8TX PoE-EEC" on page 26](#)

### 1.4.1 10/100 Mbit/s twisted pair port

This port is a 4-pin, "D"-coded M12 socket.

The 10/100 Mbit/s twisted pair port allows you to connect network components according to the IEEE 802.3 10BASE-T/100BASE-TX standard.

This port supports:

- ▶ Autonegotiation
- ▶ Autopolarity
- ▶ Autocrossing (if autonegotiation is activated)
- ▶ 100 Mbit/s half-duplex mode, 100 Mbit/s full duplex mode
- ▶ 10 Mbit/s half-duplex mode, 10 Mbit/s full duplex mode

Delivery state: Autonegotiation activated

The screw threads of the M12 ports are electrically connected to the device casing.

### 1.4.2 10/100 Mbit/s PoE port

The PoE ports support the connection and a remote power supply of (for example) IP phones (Voice-over-IP), webcams, sensors, print servers, and WLAN access points. With PoE, these end devices are powered via the twisted pair cable.

This port is a 4-pin, “D”-coded M12 socket.

The 10/100 Mbit/s PoE(+) port allows you to connect network components as a powered device (PD) according to standards IEEE 802.3 10BASE-T/100BASE-TX and IEEE 802.3af/at.

This port supports:

- ▶ Autonegotiation
- ▶ Autopolarity
- ▶ Autocrossing
- ▶ 100 Mbit/s half-duplex mode, 100 Mbit/s full duplex mode
- ▶ 10 Mbit/s half-duplex mode, 10 Mbit/s full duplex mode
- ▶ Power over Ethernet (PoE/PoE+)

Devices are supplied with PoE voltage (54 V DC SELV) using the internal power supply. PoE voltage via twisted pair cables is supplied using the wire pairs transmitting the signal (phantom supply).

Delivery state: Autonegotiation activated

The screw threads of the M12 ports are electrically connected to the device casing.

The PoE voltage is uncoupled from the power supply.

The maximum PoE output of the device is 35 W.

### 1.4.3 Pin assignment OCTOPUS 8TX-EEC and OCTOPUS 8TX-EEC-M

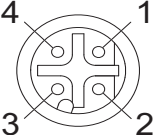
Figure	Pin	Function	
	1	TD+	Transmit Data+
	2	RD+	Receive Data+
	3	TD-	Transmit Data-
	4	RD-	Receive Data-
Housing: shield			

### 1.4.4 Pin assignment OCTOPUS 8TX PoE-EEC

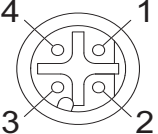
Figure	Pin	Function	PoE voltage input	
	1	TD+	Transmit Data +	V+
	2	RD+	Receive Data +	V-
	3	TD-	Transmit Data-	V+
	4	RD-	Receive Data-	V-
Casing: shield				

## 1.5 Display elements

After the supply voltage is set up, the software starts and initializes itself. During this process, various LEDs light up.

### 1.5.1 Device status

These LEDs provide information about conditions which affect the operation of the whole device.

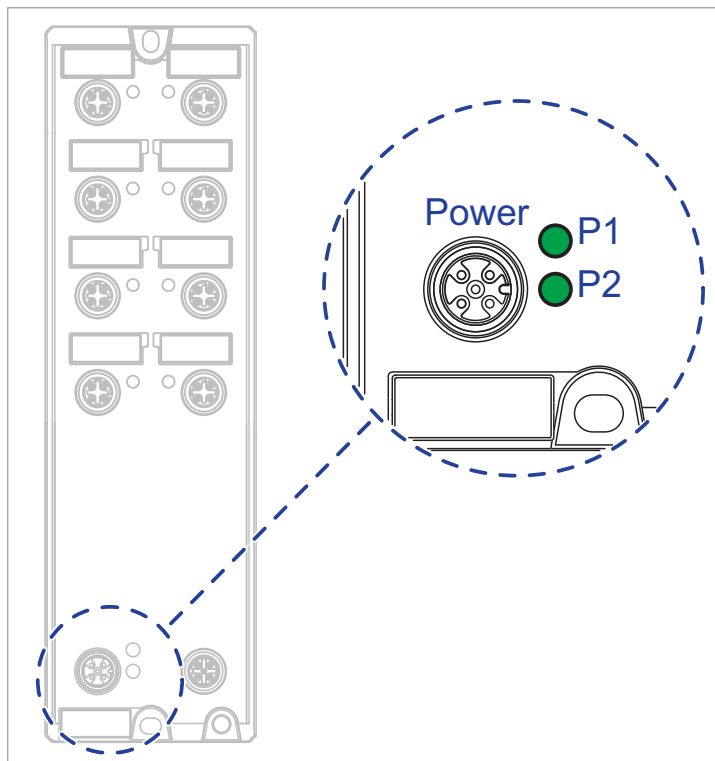

Figure 1: Display elements device status OCTOPUS 8TX-EEC

LED	Display	Color	Activity	Meaning
P1	Supply voltage 1	green	lights up	Supply voltage is on
			none	Supply voltage is too low
P2	Supply voltage 2	green	lights up	Supply voltage is on
			none	Supply voltage is too low

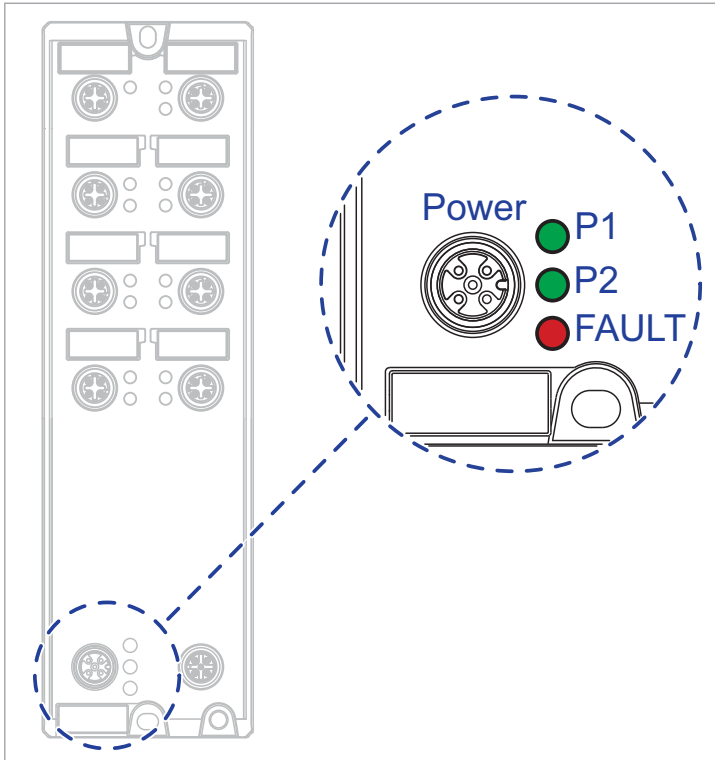

Figure 2: Display elements device status OCTOPUS 8TX PoE-EEC

LED	Display	Color	Activity	Meaning
P1	Supply voltage 1	green	lights up	Supply voltage is on
			none	Supply voltage is too low
P2	Supply voltage 2	green	lights up	Supply voltage is on
			none	Supply voltage is too low
FAULT	PoE status	red	lights up	The combined power output on the PoE ports exceeds the maximum total power output.
			none	The total PoE output is sufficient.

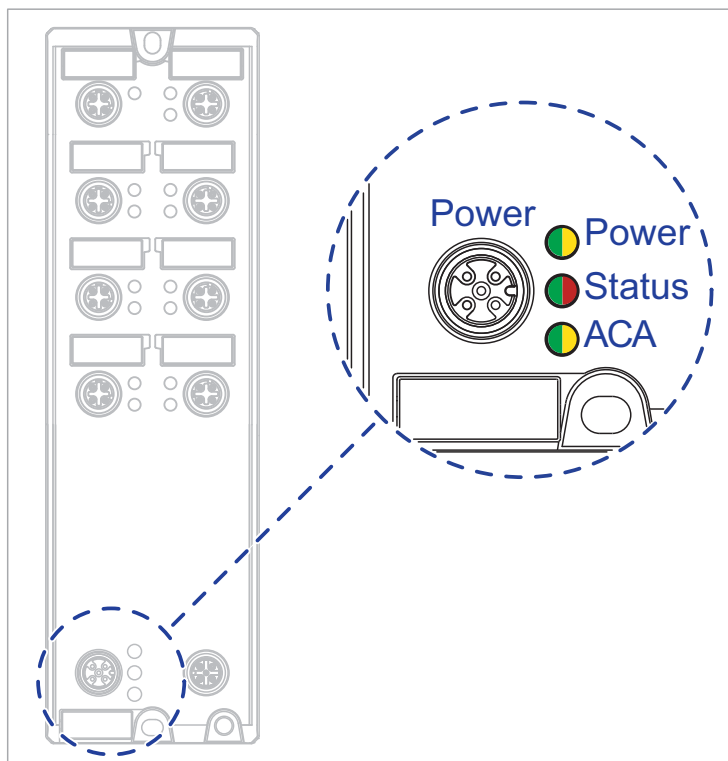

Figure 3: Display elements device status OCTOPUS 8TX-EEC-M

LED	Display	Color	Activity	Meaning		
Power	Supply voltage	—	none	Supply voltages 1 <b>and</b> 2 are too low.		
		yellow	lights up	Supply voltage 1 <b>or</b> 2 is on		
			flashes 4 times a period	Software update is running. Maintain the power supply.		
Power	Supply voltage	green	lights up	Supply voltage 1 <b>and</b> 2 is on		
		Status	Device Status	—	none	Device starts Device is not ready for operation
				green	lights up	Device is ready for operation. Characteristics can be configured
Status	Device Status	red	lights up	Device is not ready for operation		
			flashes 1 time a period	The boot parameters used when the device has been started differ from the boot parameters saved. Start the device again.		
		flashes 4 times a period	Device has detected a multiple IP address			
ACA	Storage medium ACA22-M12-C (EEC)	red/ green	flashing alternately	Device is in the recovery mode.		
		—	none	No ACA connected		
		green	lights up	ACA is plugged		
	flashes 3 x a period	Device writes to/reads from the storage medium				
	yellow	lights up	ACA is not ready for operation			

## 1.5.2 Port Status

These LEDs provide port-related information.

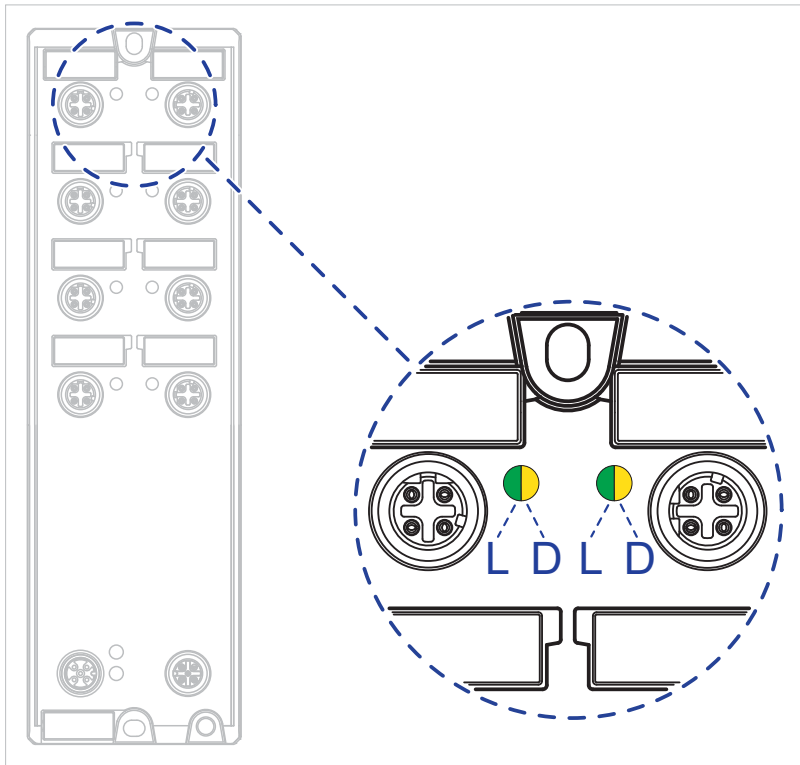

Figure 4: Display elements port status OCTOPUS 8TX-EEC

LED	Display	Color	Activity	Meaning
L/D	Link state/ data traffic	—	none	Device detects an invalid or missing link
		green	lights up	Device detects a valid link
		yellow	flashing	Device is transmitting and/or receiving data
		green/ yellow	flashing alternately	Update of the configuration via the M12 interface

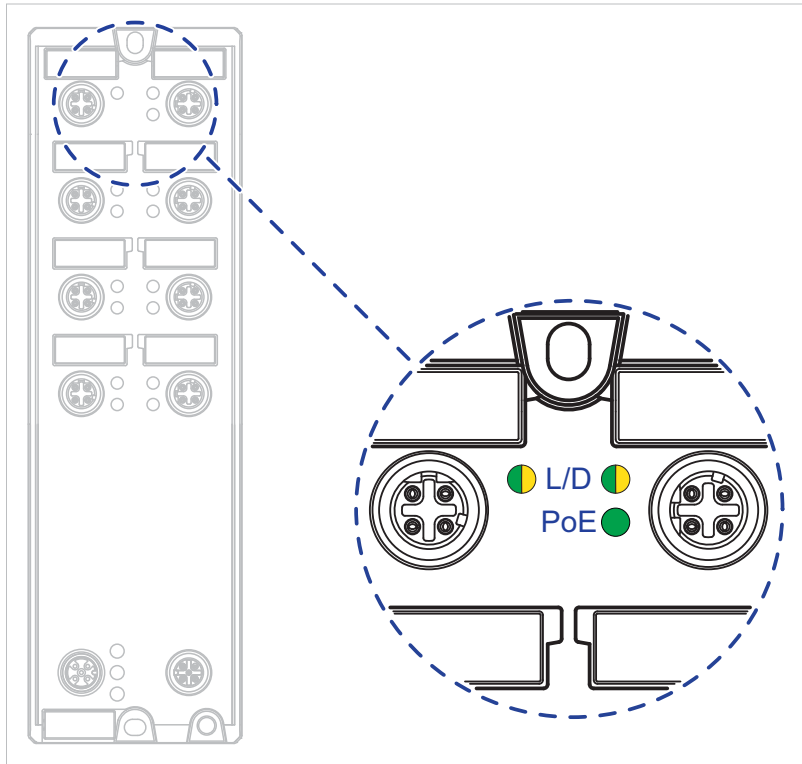

Figure 5: Display elements port status OCTOPUS 8TX PoE-EEC

LED	Display	Color	Activity	Meaning
L/D	Link state/ data traffic	—	none	Device detects an invalid or missing link
		green	lights up	Device detects a valid link
		yellow	flashing	Device is transmitting and/or receiving data
		green/ yellow	flashing alternately	Update of the configuration via the M12 interface
PoE		—	none	No powered device connected
		green	lights up	Powered device is supplied with power
			flashes 1 x a period	no power supply of the Powered Device - due to the device configuration the power output required by the Powered Device cannot be provided on this port
			flashes 3 x a period	No power supply to the powered device, as PoE is deactivated in the device management

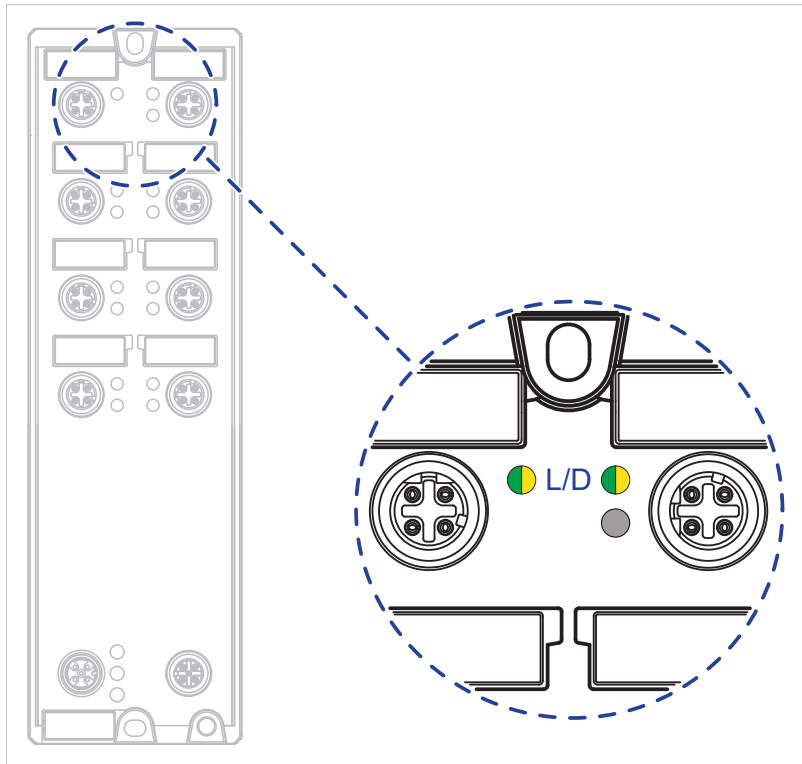

Figure 6: Display elements port status OCTOPUS 8TX-EEC-M

LED <sup>a</sup>	Display	Color	Activity	Meaning
L/D	Link state/ data traffic	—	none	Device detects an invalid or missing link
		green	lights up	Device detects a valid link
			flashes 1 × a period	Port is switched to stand-by
			flashes 3 × a period	Port is switched off
		yellow	flashing	Device is transmitting and/or receiving data

- a. In the present hardware version, the lower port LEDs of the M12 ports are without function. The port status is displayed via the upper port LED.



## 1.6 Management interfaces

### 1.6.1 ACA-M12 interface

This applies to the following device variants only:

- ▶ OCTOPUS 8TX-EEC
- ▶ OCTOPUS 8TX PoE-EEC

This interface is a 5-pin, “A”-coded M12 socket with shielding.

This interface allows you to connect the ACA21-M12 (EEC) or ACA22-M12 (EEC) storage medium.

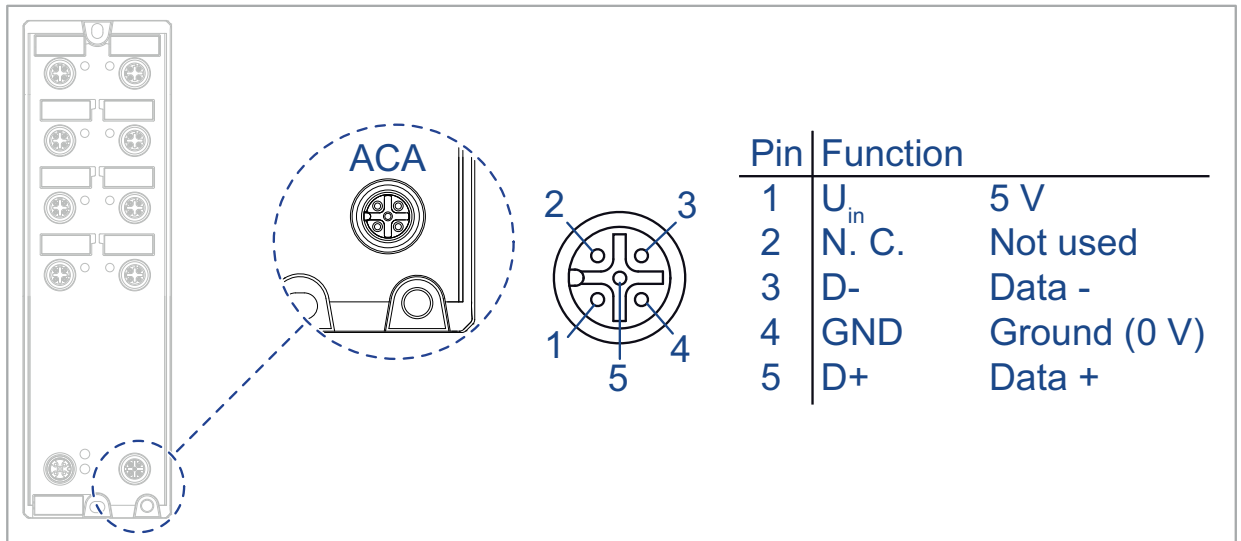

Figure 7: ACA M12 interface

**Note:** The USB connector is for temporary connection only.

## 1.6.2 ACA22-C interface

This applies to the following device variants only:

- ▶ OCTOPUS 8TX-EEC-M

This interface is a 5-pin, “A”-coded M12 socket with shielding. This interface is **NOT** electrically isolated from the power supply input.

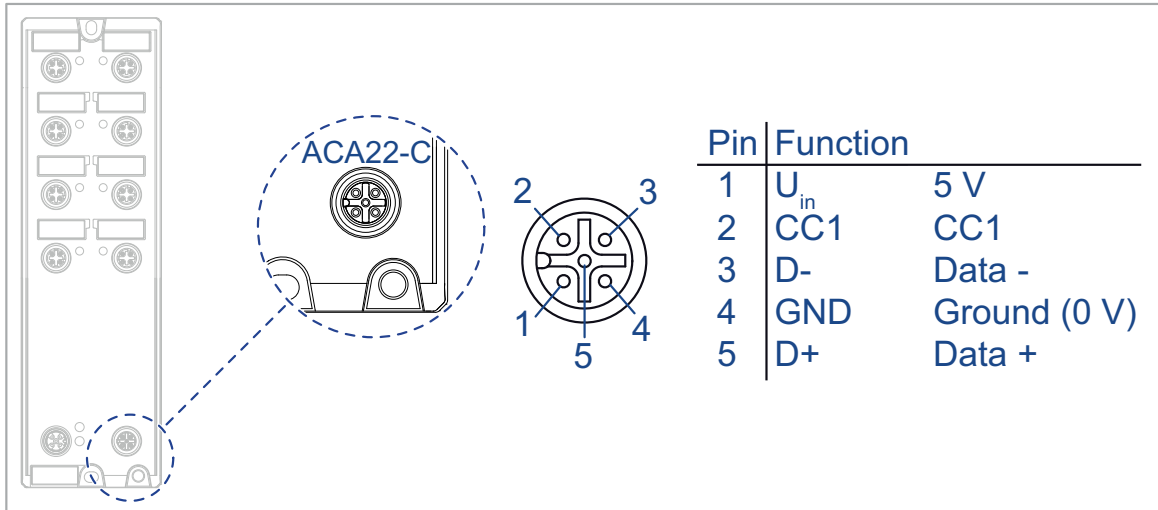

Figure 8: ACA22-C interface: Position on the device and pin assignment

The interface was designed for the use with the external storage medium AutoConfiguration Adapter ACA22-M12-C (EEC). Additionally, the interface allows you to connect your device temporarily via terminal emulation or network to an external device using an adapter cable. The adapter cable is available as an accessory (see on page 63 “Accessories”).

The interface allows you to configure, manage and check your device.

The interface has the following properties:

- ▶ Supports the USB Host mode and USB Device mode
- ▶ Supports USB 2.0 (data rate max. 480 Mbit/s)
- ▶ Supplies current of max. 500 mA
- ▶ Voltage NOT potential-separated
- ▶ Supported file system: FAT32

### ■ Configuration via ACA22-M12-C (EEC)

You have the option to connect the storage medium AutoConfiguration Adapter ACA22-M12-C (EEC). It is used for saving/loading the configuration data and diagnostic information, and for loading the software. You find detailed information on the configuration via ACA22-M12-C (EEC) in the software user documentation. You find the software user documentation as PDF files on the Internet at <https://www.doc.hirschmann.com>.

**Note:** The ACA22-M12-C (EEC) storage medium can remain permanently connected to the device.

### ■ Configuration, management and checking via adapter cable

You have the option to configure, manage and check your device via the interface using an adapter cable. You find detailed information in the software user documentation. You find the software user documentation as PDF files on the Internet at <https://www.doc.hirschmann.com>. The adapter cable is available as an accessory (see on page 63 “Accessories”).

**Note:** The interface is NOT electrically isolated from the power supply input. For this reason, exclusively connect adapter cables temporarily. Adapter cables may exclusively be used to configure, manage and check your device

### 1.6.3 Signal contact

This applies to the following device variants only:

- ▶ OCTOPUS 8TX-EEC-M

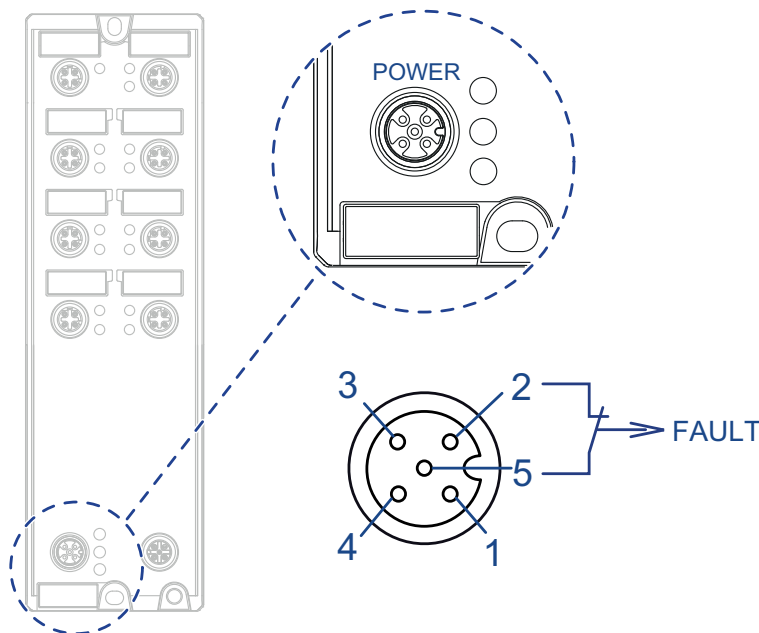

Figure 9: Signal contact OCTOPUS 8TX-EEC-M

The signal contact is a potential-free relay contact. The signal contact is open when the device is not connected to a power supply.

The signal contact allows you to control external devices or monitor device functions.

In the configuration, you specify how the device uses the signal contact.

You will find detailed information on possible applications and the configuration of the signal contact in the software user documentation. You will find the software user documentation as PDF files on the Internet at <https://www.doc.hirschmann.com>

## 2 Installation

The devices have been developed for practical application in a harsh industrial environment.

On delivery, the device is ready for operation.

Perform the following steps to install and configure the device:

- ▶ [Checking the package contents](#)
- ▶ [Installing and grounding the device](#)
- ▶ [Connecting the power supply and the signal contact lines](#)
- ▶ [Operating the device](#)
- ▶ [Connecting data cables](#)
- ▶ [Configuration \(optional\)](#)

### 2.1 Checking the package contents

- Check whether the package includes all items named in the section [“Scope of delivery” on page 63](#).
- Check the individual parts for transport damage.

### 2.2 Installing and grounding the device

#### 2.2.1 Mounting on a flat surface

##### **Requirements:**

- Select the installation site so that the climatic threshold values listed in the technical data are observed.  
[See “Technical data” on page 54](#).
- To protect the exposed uninstalled contacts of the components from dirt, connect the individual system components in a dry and clean working area.
- To sustain the IP65/67 suitability for your device, seal all unused connections and ports with the provided plastic protection screws. See [“Scope of delivery” on page 63](#). See [“Accessories” on page 63](#) in case of an additional demand.
- To sustain the IP69K suitability for your device, seal all unused connections and ports with metal protection screws. See [“Accessories” on page 63](#) in case of additional demand.

- To sustain the IP65/67/69K suitability for your device, exclusively connect components with degree of protection IP65/67/69K.
- To sustain the IPX9K suitability for your device, cover the rear side of the device.

**Note:** The torque for tightening the protection screws on the device is 5.3 lb-in (0.6 Nm).

Perform the following work steps:

- Prepare the drill holes at the installation point.  
[See “Dimension drawings” on page 58.](#)
- Mount the device on a level surface with two M4 screws.

### 2.2.2 Grounding the device

#### **Requirements:**

- Use a suitable wire diameter for the functional grounding. Hirschmann recommends a wire diameter of 0.5 mm<sup>2</sup> (AWG20).
- Use toothed washers to ensure good electrical conductivity at the connection.
- Ground the device via an M4 screw.
- Note the maximum screw-in depth of 0.295 in (7.5 mm) for OCTOPUS 8TX PoE-EEC and OCTOPUS 8TX-EEC-M devices.

**Note:** The grounding screw is not included in the scope of delivery.

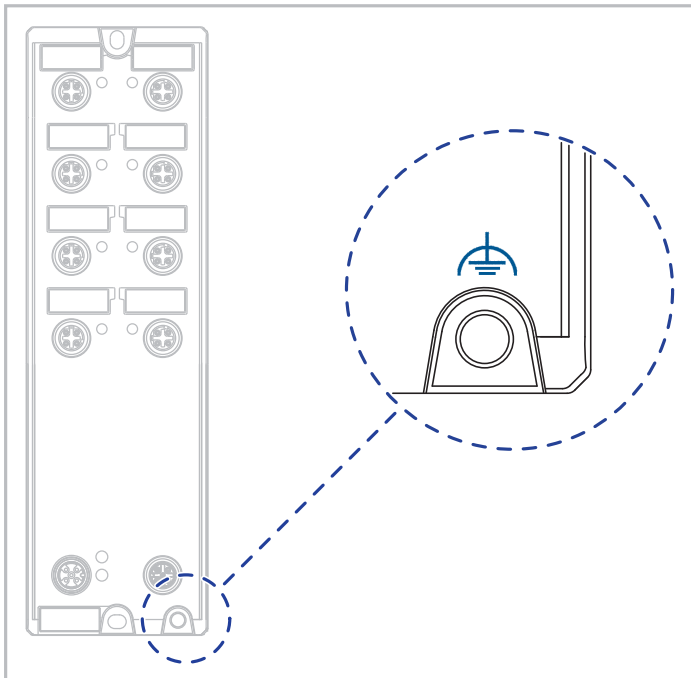

*Figure 10: Functional ground on the device*

Perform the following work steps:

- Grounding the device is by means of a separate ground connection on the device.  
For the position of the ground connection on the device see [figure 10](#).
- Ground the device before connecting any other cables.
- Disconnect the grounding only after disconnecting all other cables.

## 2.3 Connecting the power supply and the signal contact lines

### Requirements:

- ▶ The power supply cable is suitable for the voltage, the current and the physical load. Hirschmann recommends a conductor cross section of 0.5 mm<sup>2</sup> to 0.75 mm<sup>2</sup> (AWG20 up to AWG18).
- ▶ The permitted cable diameter for connector ELWIK A 5012 PG7 is 4 mm (0.15 in) to 6 mm (0.23 in). To ensure the watertightness of the OCTOPUS 8TX-EEC device, only use voltage supply cables with a diameter within the specified range.
- ▶ Make sure that the disconnecting device is easily accessible for disconnecting the device from the mains voltage.

**Note:** The supply voltage can be connected redundantly. Both plus connections are uncoupled. There is no distributed load. With redundant supply, the power supply unit with the higher output voltage supplies the device on its own. The supply voltage is electrically isolated from the housing. PoE devices have no PoE buffering.

Perform the following work steps:

- Mount the connector for the supply voltage.

### 2.3.1 Connecting the signal contact (optional)

This applies to the following device variants only:

- ▶ OCTOPUS 8TX-EEC-M

Perform the following work steps:

- Connect the wires for the supply voltage and the signal contact according to the pin assignment with a suitable socket.

### 2.3.2 Pin assignment OCTOPUS 8TX-EEC

M12 5-pin ("A"- coded)	Pin	Function
	1	Power supply (1): + 12/24/36 V DC (1)
	2	Not used
	3	0 V
	4	Power supply (2): + 12/24/36 V DC (2)
	5	Not used

### 2.3.3 Pin assignment OCTOPUS 8TX PoE-EEC

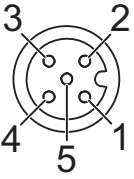
M12 5-pin ("A"- coded)	Pin	Function
	1	Power supply (1): +24 V DC (1)
	2	Not used
	3	0 V
	4	Power supply (2): +24 V DC (2)
	5	Not used

### 2.3.4 Pin assignment OCTOPUS 8TX-EEC-M

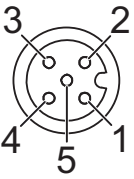
M12 5-pin ("A"- coded)	Pin	Function
	1	Power supply (1): + 24/36 V DC (1)
	2	Signal contact
	3	0 V
	4	Power supply (2): + 24/36 V DC (2)
	5	Signal contact

## 2.4 Operating the device

When you connect the supply voltage, you start up the device.



## 2.5 Connecting data cables

Note the following general recommendations for data cable connections in environments with high electrical interference levels:

- Keep the length of the data cables as short as possible.
- Use optical data cables for the data transmission between the buildings.
- When using copper cables, provide a sufficient separation between the power supply cables and the data cables. Ideally, install the cables in separate cable channels.
- Verify that power supply cables and data cables do not run parallel over longer distances. To reduce inductive coupling, verify that the power supply cables and data cables cross at a 90 ° angle.
- Use shielded data cables for gigabit transmission via copper cables, for example SF/UTP cables according to ISO/IEC 11801. To meet EN 50121-4 and marine application requirements, use shielded data cables at all transmission rates.
- Connect the data cables according to your requirements.  
[See “Ethernet ports” on page 25.](#)
- Seal all unused connections and ports with the provided plastic protection screws. See [“Scope of delivery” on page 63](#). See [“Accessories” on page 63](#) in case of an additional demand.

**Note:** The torque for tightening the protection screws on the device is 5.3 lb-in (0.6 Nm).

Perform the following work steps:

- Connect the data cables according to your requirements.
- Make sure the cable shielding is connected to the M12 plug thread.

## 2.6 Configuration (optional)

This applies to the following device variants only:

- ▶ OCTOPUS 8TX-EEC
- ▶ OCTOPUS 8TX PoE-EEC

The device is immediately ready for operation with its default settings, from the factory.

You have the option to change the settings according to your requirements using the ACA M12 interface.

You can find the configuration parameters described in a separate overview.

[See table 1 on page 46.](#)

### Requirements:

#### ▶ **Switch Programming Tool**

You can download the software for free on the Internet from the Hirschmann product pages:

[www.hirschmann.com/en/QR/Switch-Programing-Tool](http://www.hirschmann.com/en/QR/Switch-Programing-Tool)

#### ▶ **M12 USB Adapter**

You can connect the storage medium ACA21-M12 (EEC) or ACA22-M12 (EEC) to your PC using the M12 USB Adapter.

The M12 USB Adapter is available as an accessory.

[See “Accessories” on page 63.](#)

#### ▶ **ACA21-M12 (EEC) or ACA22-M12 (EEC)**

You have the option to transfer configuration data to your device or read out the configuration using a storage medium.

The storage medium is available as an accessory.

[See “Accessories” on page 63.](#)

Perform the following work steps:

- Connect the storage medium to the device.
- Start the Switch Programming Tool.
- Select your device variant from the drop-down list “Device Type”.

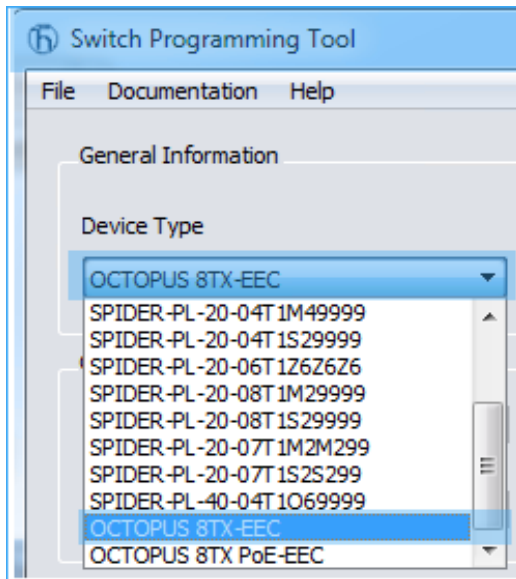

- Modify the parameters in the highlighted areas according to your requirements.

**Switch Programming Tool**  
File Documentation Help

**General Information**

Device Type: **OCTOPUS 8TX PoE-EEC**

Serial Number: **942151001**

Contact Location: **Configure**

**Global Parameters**

Power Supply 1 Alarm: **Enable**

Power Supply 2 Alarm: **Enable**

Aging Time (s): **300**

QoS Trust Mode: **trustDotIp**

**Port Parameters**

Port State: **On**

Link Alarm: **Off**

Auto Negotiation: **On**

Speed: **-**

Duplex Mode: **FDX**

Auto Crossing: **On**

MDI State: **MDIX**

Flow Control: **Off**

Broadcast Mode: **Off**

Broadcast Threshold (%): **100**

Multicast Mode: **Off**

Multicast Threshold (%): **100**

Jumbo Frames: **Off**

Port Priority: **0**

Energy Efficient Ethernet: **Off**

PoE State: **On**

PoE Priority: **Low**

PoE Classes: **0,1,2,3,4**

**Active/Configured Port Settings**

Port	Port State	Link Alarm	Auto Negotiation	Speed	Duplex Mode	Auto Crossing	MDI State	Flow Control	Broadcast Mode	Broadcast Threshold	Multicast Mode	Multicast Threshold	Jumbo Frames	QoS Trust Mode	Port Priority	Energy Efficient Ethernet	PoE State	PoE Priority	PoE Classes
Port 1	On	Off	On	-	FDX	On	MDIX	Off	Off	100	Off	100	Off	trustDotIp	0	Off	On	Low	0,1,2,3,4
Port 2	On	Off	On	-	FDX	On	MDIX	Off	Off	100	Off	100	Off	trustDotIp	0	Off	On	Low	0,1,2,3,4
Port 3	On	Off	On	-	FDX	On	MDIX	Off	Off	100	Off	100	Off	trustDotIp	0	Off	On	Low	0,1,2,3,4
Port 4	On	Off	On	-	FDX	On	MDIX	Off	Off	100	Off	100	Off	trustDotIp	0	Off	On	Low	0,1,2,3,4
Port 5	On	Off	On	-	FDX	On	MDIX	Off	Off	100	Off	100	Off	trustDotIp	0	Off	On	Low	0,1,2,3,4
Port 6	On	Off	On	-	FDX	On	MDIX	Off	Off	100	Off	100	Off	trustDotIp	0	Off	On	Low	0,1,2,3,4
Port 7	On	Off	On	-	FDX	On	MDIX	Off	Off	100	Off	100	Off	trustDotIp	0	Off	On	Low	0,1,2,3,4
Port 8	On	Off	On	-	FDX	On	MDIX	Off	Off	100	Off	100	Off	trustDotIp	0	Off	On	Low	0,1,2,3,4

Save the configuration file to the storage medium.

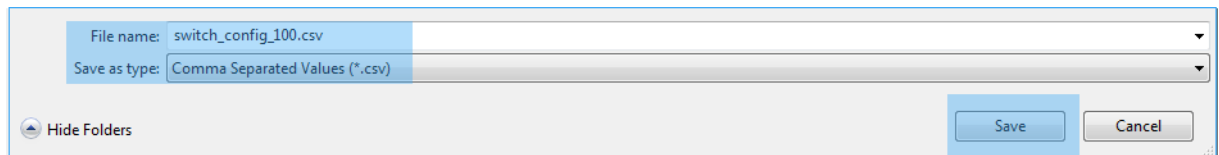
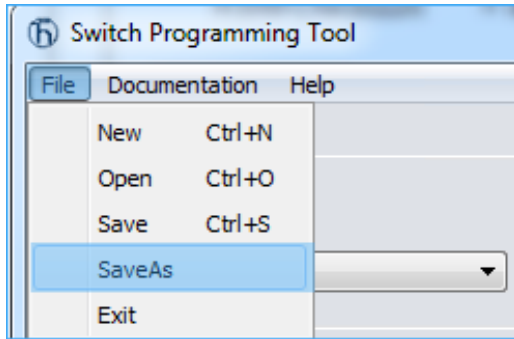

- Disconnect the M12 USB Adapter from your PC.
- Disconnect the storage medium from the M12 USB Adapter.
- ▶ Transfer the configuration data to your device by following these steps:
  - Verify that the device is switched off.
  - Connect the storage medium to the device.
  - Switch on the device.
- ▶ The device reads the csv file on the storage medium and adopts the settings. During this time, the LEDs “**L/D**” flash alternately in **yellow/green**.

	Parameter	Values	Default values	Comment
global	Aging time	Aging time in s	300 s	Value range 0 ... 1048575
	QoS 802.1p mapping	VLAN Priority 0 ... 7 Traffic Class 0 ... 3	VLAN Priority	Traffic Class
			0	1
			1	0
2			0	
			3	1
			4	2
			5	2
			6	3
			7	3
	QoS DSCP mapping	DSCP value 0 ... 63 Traffic Class 0 ... 3	See table 2 on page 47.	
	QoS Trust Mode	untrusted, trustDot1p, trustIpDscp	trustDot1p	This also includes VLAN 0 mode for Profinet applications.
per port	Flow control	enabled / disabled	disabled	
	Port admin state	enabled / disabled	enabled	
	Jumbo frames	enabled / disabled	disabled	Globally enabled if at least one port is enabled
	Broadcast storm protection	enabled / disabled	disabled	Ingress rate limiter
	Broadcast storm threshold	0% ... 100%	100%	
	Multicast storm protection	enabled / disabled	disabled	Ingress rate limiter
	Multicast storm threshold	0% ... 100%	100%	
	Link alarm	enabled / disabled	disabled	
per TP port	Autonegotiation	enabled / disabled	enabled	
	Speed	100 Mbit/s, 10 Mbit/s	100 Mbit/s	Only if autonegotiation is disabled
	Duplex mode	FDX / HDX	FDX	Only if autonegotiation is disabled
	Autocrossing	enabled / disabled	enabled	Only if autonegotiation is disabled
	MDI state	MDI, MDI-X	MDI-X	Only if autonegotiation and autocrossing is disabled

Table 1: Configuration parameters

	Parameter	Values	Default values	Comment
per PoE port	PoE enable	enabled / disabled	enabled	
	PoE priority	low, high, critical	low	critical is highest
	(PoE allowed classes)	class 0, 1, 2, 3, 4	class 0, 1, 2, 3, 4	all combinations configurable

*Table 1: Configuration parameters*

d2/d1	0	1	2	3	4	5	6
0:	1	0	0	1	2	3	3
1:	1	0	0	1	2	3	3
2:	1	0	0	2	2	3	3
3:	1	0	0	2	2	3	3
4:	1	0	1	2	2	3	
5:	1	0	1	2	2	3	
6:	1	0	1	2	2	3	
7:	1	0	1	2	2	3	
8:	0	0	1	2	3	3	
9:	0	0	1	2	3	3	

*Table 2: DSCP mapping table*

## 2.6.1 Configuration readout

Perform the following steps to start up the device:

- Connect the storage medium to your PC using the M12 USB Adapter.
  - Create a text file in the root directory of the storage medium.
  - Rename the text file to “**ShowRunningConfiguration.txt**”.
  - Disconnect the storage medium from the M12 USB Adapter.
  - Connect the storage medium to the device.
  - Restart the device by disconnecting the power supply for a moment.
- 
- ▶ When the text file “**ShowRunningConfiguration.txt**” in the root directory of the device is found, the device creates a file with the current configuration.
  - ▶ You will find this file in the root directory of the storage medium under the name “**Running\_Config.txt**”.



## 3 Making basic settings

This applies to the following device variants only:

- ▶ OCTOPUS 8TX-EEC-M

**Note:** 2 or more devices configured with the same IP address can cause unpredictable operation of your network.

Install and maintain a process that assigns a unique IP address to every device in the network.

The IP parameters must be entered when the device is installed for the first time. The device provides the following options for configuring IP addresses:

- ▶ Input via the HiView or Industrial HiVision application. You find further information about the applications HiView or Industrial HiVision on the Internet at the Hirschmann product pages:

### **HiView**

<http://www.hirschmann.com/en/QR/INET-HiView>

### **Industrial HiVision**

<http://www.hirschmann.com/en/QR/INET-Industrial-HiVision>

- ▶ Configuration via BOOTP
  - ▶ Configuration via DHCP (Option 82)
  - ▶ AutoConfiguration AdapterACA22-M12-C (EEC)
  - ▶ Configuration via ACA22-C interface
- 
- Default settings
    - ▶ IP address: The device looks for the IP address using DHCP
    - ▶ Management password:
      - user, password: public (read only)
      - admin, password: private (read/write)
    - ▶ Ethernet ports: link status is not evaluated (signal contact)
    - ▶ RSTP (Rapid Spanning Tree) activated

## 3.1 First login (Password change)

To help prevent undesired access to the device, it is imperative that you change the default password during initial setup.

Perform the following steps:

- Open the Graphical User Interface, the Command Line Interface, or HiView the first time you log on to the device.
- Log on to the device with the default password “private”. The device prompts you to type in a new password.
- Type in your new password.  
To help increase security, choose a password that contains at least 8 characters which includes upper-case characters, lower-case characters, numerical digits, and special characters.
- When you log on to the device with the Command Line Interface, then the device prompts you to confirm your new password.
- Log on to the device again with your new password.

**Note:** If you lost your password, then use the System Monitor to reset the password.

For further information see:

<https://hirschmann-support.belden.com/en/kb/required-password-change-new-procedure-for-first-time-login>

## 4 Monitoring the ambient air temperature

Operate the device below the specified maximum ambient air temperature exclusively.

See [“General technical data” on page 54](#).

The ambient air temperature is the temperature of the air at a distance of 5 cm (2 in) from the device. It depends on the installation conditions of the device, for example the distance from other devices or other objects, and the output of neighboring devices.

This applies to the following device variants only:

- ▶ OCTOPUS 8TX-EEC-M

The temperature displayed in the CLI (Command Line Interface) and the GUI (Graphical User Interface) is the internal temperature of the device. It is higher than the ambient air temperature. The maximum internal temperature of the device named in the technical data is a guideline that indicates to you that the maximum ambient air temperature has possibly been exceeded.

## 5 Maintenance and service

- ▶ When designing this device, Hirschmann largely avoided using high-wear parts. The parts subject to wear and tear are dimensioned to last longer than the lifetime of the product when it is operated normally. Operate this device according to the specifications.
- ▶ Relays are subject to natural wear. This wear depends on the frequency of the switching operations. Check the resistance of the closed relay contacts and the switching function depending on the frequency of the switching operations.
- ▶ Hirschmann is continually working on improving and developing their software. Check regularly whether there is an updated version of the software that provides you with additional benefits. You find information and software downloads on the Hirschmann product pages on the Internet (<http://www.hirschmann.com>).
- ▶ Depending on the degree of pollution in the operating environment, check at regular intervals that the ventilation slots in the device are not obstructed.

**Note:** You find information on settling complaints on the Internet at <http://www.beldensolutions.com/en/Service/Repairs/index.phtml>.

## 6 Disassembly

Perform the following work steps:

- Disable the supply voltage.
- Disconnect the data cables.
- Disconnect the grounding.
- Unmount the device.

# 7 Technical data

## 7.1 General technical data

Dimensions W x D x H	OCTOPUS 8TX-EEC	2.40 in x 1.22 in x 7.91 in (61 mm x 31 mm x 201 mm)
	OCTOPUS 8TX PoE-EEC	2.40 in x 1.81 in x 7.91 in (61 mm x 46 mm x 201 mm)
	OCTOPUS 8TX-EEC-M	2.40 in x 1.81 in x 7.91 in (61 mm x 46 mm x 201 mm)
Weight	OCTOPUS 8TX-EEC	1.1 lb (0.5 kg)
	OCTOPUS 8TX PoE-EEC	2 lb (0.9 kg)
	OCTOPUS 8TX-EEC-M	2 lb (0.9 kg)
Power supply OCTOPUS 8TX-EEC	Safety extra-low voltage (SELV)	
	Relevant for North America: NEC Class 2 power source max. 2 A.	
	Rated voltage	12/24/36 V DC
	Voltage range incl. maximum tolerances	9.6 V DC ... 45 V DC
	Rated voltage for rail applications according to EN 50155	24/36 V DC
	Voltage range including maximum tolerances for rail applications according to EN 50155 (permanent)	16.8 V DC ... 45 V DC
	Voltage range including maximum tolerances for rail applications according to EN 50155 (0.6 x U <sub>N</sub> for 0.1 s; 1.4 x U <sub>N</sub> for 1 s)	14.4 V DC ... 50.4 V DC
	Connection type	5-pin, "A"-coded M12 connector
	Power loss buffer	>10 ms
	Back-up fuse for each voltage input when supplied via 1 input	Nominal rating: 1 A ... 4 A Characteristic: slow blow
	Back-up fuse for each voltage input when supply is via 2 inputs	Nominal rating: 1 A ... 2 A Characteristic: slow blow
Peak inrush current	<1.4 A (1ms)	
Current integral I <sup>2</sup> t	0.15 A <sup>2</sup> s	

Power supply	Safety extra-low voltage (SELV)	
OCTOPUS 8TX PoE-EEC	Relevant for North America: NEC Class 2 power source max. 2 A.	
Rated voltage	24 V DC	
Voltage range incl. maximum tolerances	16.8 V DC ... 32 V DC	
Rated voltage for rail applications according to EN 50155	24 V DC	
Voltage range including maximum tolerances for rail applications according to EN 50155 (permanent)	16.8 V DC ... 30 V DC	
Voltage range including maximum tolerances for rail applications according to EN 50155 (0.6 × U <sub>N</sub> for 0.1 s; 1.4 × U <sub>N</sub> for 1 s)	14.4 V DC ... 33.6 V DC	
Connection type	5-pin, "A"-coded M12 connector	
Power loss buffer	>10 ms during data transmission; no power loss buffer for PoE	
Back-up fuse for each voltage input when supplied via 1 input	Nominal rating:	3.5 A ... 4 A
	Characteristic:	slow blow
Back-up fuse for each voltage input when supply is via 2 inputs	Nominal rating:	3.5 A ... 4 A
	Characteristic:	slow blow
Peak inrush current	<5 A (1 ms)	
Current integral I <sup>2</sup> t	0.22 A <sup>2</sup> s	

Power supply OCTOPUS 8TX-EEC-M	Safety extra-low voltage (SELV)			
	Rated voltage	24/36 V DC		
	Voltage range incl. maximum tolerances	16.8 V DC ... 45 V DC		
	Rated voltage for rail applications according to EN 50155	24/36 V DC		
	Voltage range including maximum tolerances for rail applications according to EN 50155 (permanent)	16.8 V DC ... 45 V DC		
	Voltage range including maximum tolerances for rail applications according to EN 50155 (0.6 × U <sub>N</sub> for 0.1 s; 1.4 × U <sub>N</sub> for 1 s)	14.4 V DC ... 50.4 V DC		
	Connection type	5-pin, "A"-coded M12 connector		
	Power loss buffer	>10 ms		
	Back-up fuse for each voltage input when supplied via 1 input	Nominal rating:	2 A ... 10 A	Characteristic: slow blow
	Back-up fuse for each voltage input when supply is via 2 inputs	Nominal rating:	2 A ... 10 A	Characteristic: slow blow
	Peak inrush current	1.2 A		
	Current integral I <sup>2</sup> t	<0.1 A <sup>2</sup> s		
	Signal contact "FAULT" <a href="#">See "Signal contact" on page 62.</a>	Switching current	max. 1 A	
		Switching voltage	max. 60 V DC or max. 30 V AC SELV according to IEC 60950-1 or ES1 according to IEC/EN 62368-1	
Climatic conditions during operation	Ambient air temperature <sup>a</sup>	up to 2000 m ASL (6562 ft ASL)	-40 °C ... +70 °C (-40 °F ... +158 °F)	
		6562 ft ASL ... 13123 ft ASL (2000 m ASL ... 4000 m ASL)	-40 °C ... +65 °C (-40 °F ... +149 °F)	
		Humidity	5 % ... 100 % (also in condensing atmospheres)	
	Air pressure	Without derating	min. 795 hPa (+2000 m ASL; +6562 ft ASL)	max. 1060 hPa (-400 m ASL; -1312 ft ASL)
		With derating	min. 600 hPa (+4000 m ASL; +13123 ft ASL)	max. 1060 hPa (-400 m ASL; -1312 ft ASL)



Climatic conditions during storage	Ambient air temperature <sup>a</sup>	-40 °C ... +85 °C (-40 °F ... +185 °F)	up to 3 months
		-40 °C ... +70 °C (-40 °F ... +158 °F)	up to 1 year
		-40 °C ... +50 °C (-40 °F ... +122 °F)	up to 2 years
		0 °C ... +30 °C (+32 °F ... +86 °F)	up to 10 years
	Humidity	5 % ... 100 % (also in condensing atmospheres)	
	Air pressure	min. 700 hPa (+3000 m ASL; +9842 ft ASL) max. 1060 hPa (-400 m ASL; -1312 ft ASL)	
Protection classes	Degree of protection	IP65/67/69K	
Pollution degree		4	

a. Temperature of the ambient air at a distance of 5 cm (2 in) from the device

## 7.2 Dimension drawings

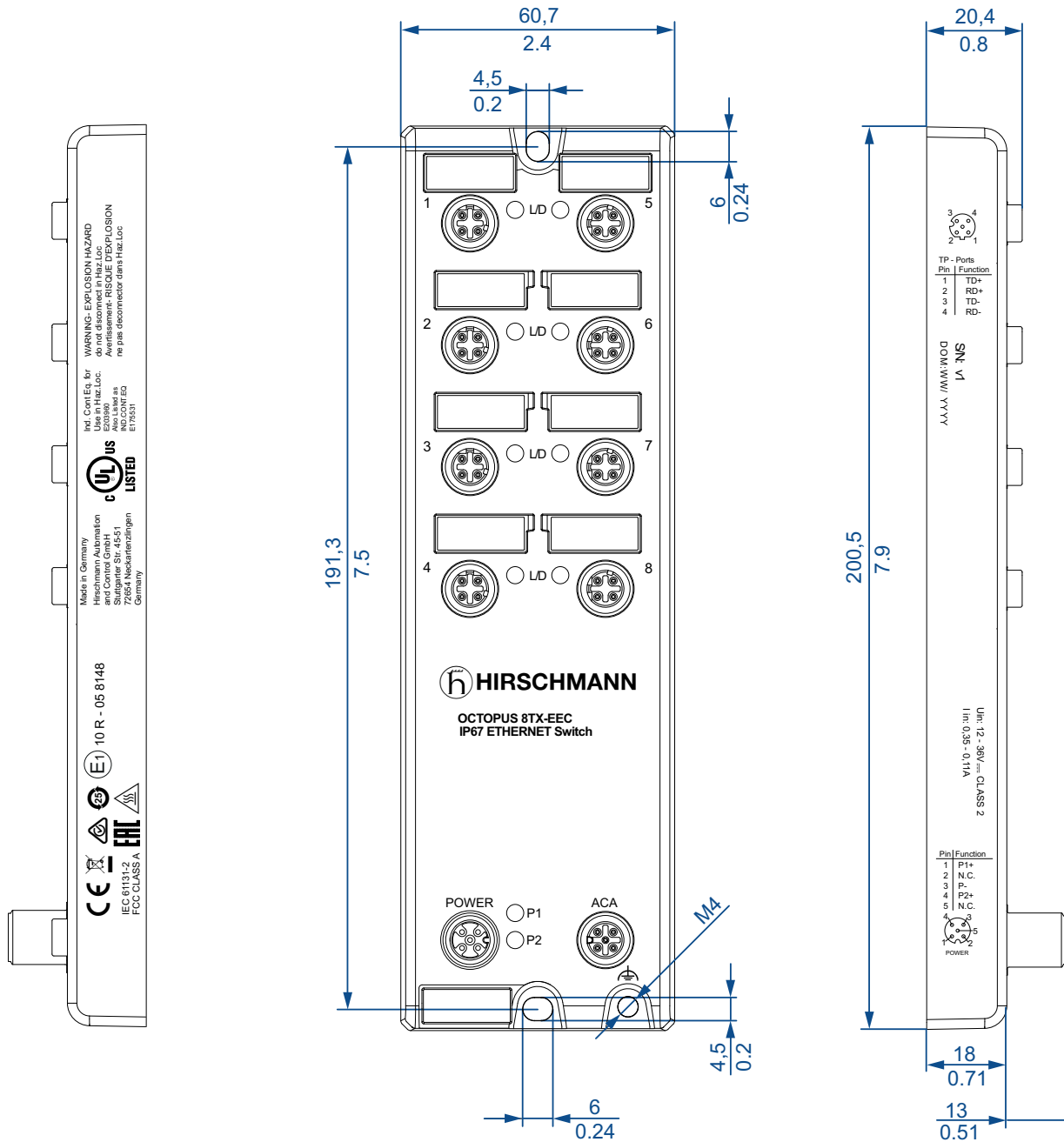

Figure 11: OCTOPUS 8TX-EEC



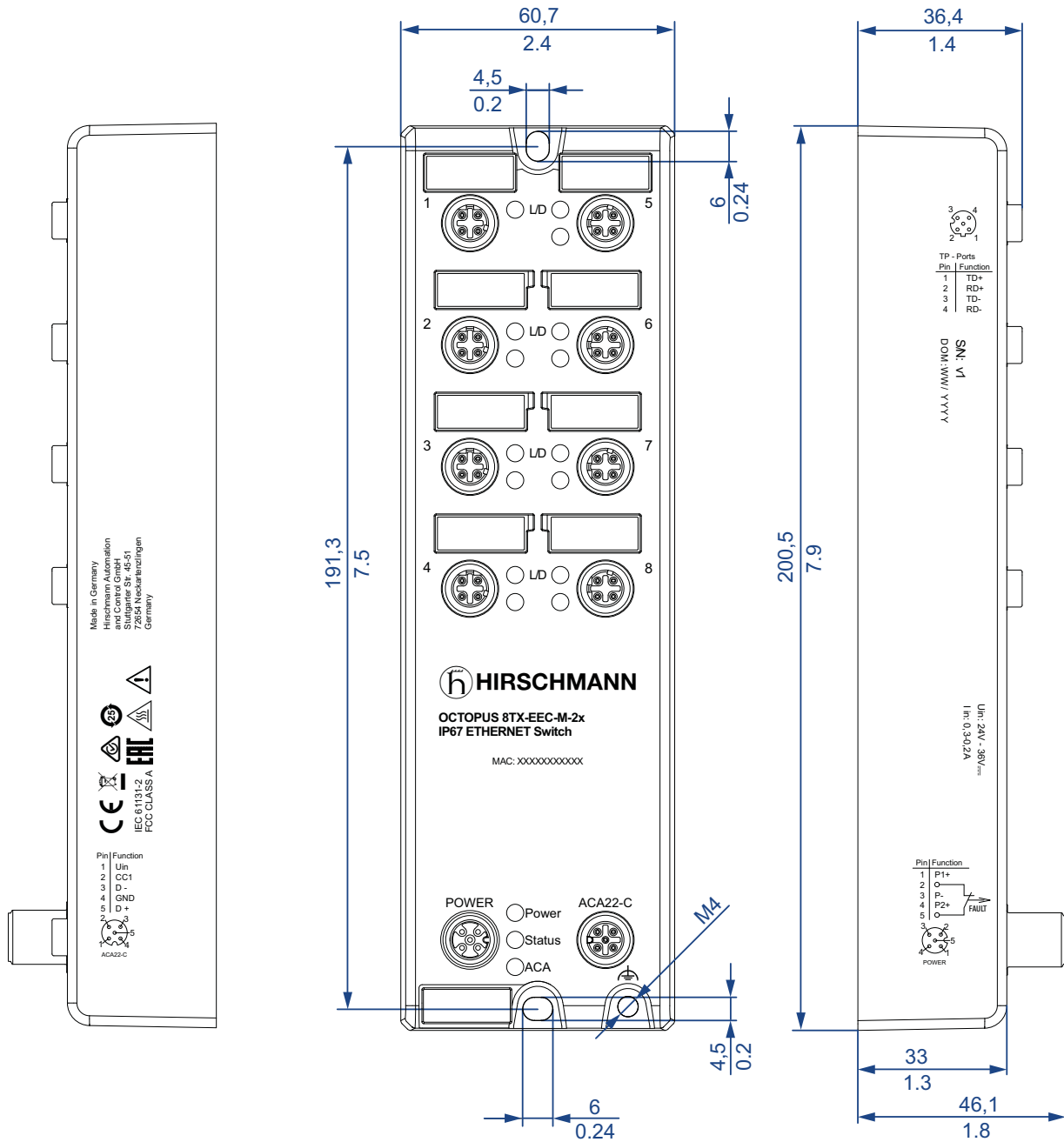

Figure 13: OCTOPUS 8TX-EEC-M

## 7.3 EMC and immunity

<b>EMC interference emission</b>		
<b>Radiated emission</b>		
EN 55032		Class A
FCC 47 CFR Part 15		Class A
EN 61000-6-4		Fulfilled
<b>Conducted emission</b>		
EN 55032	Supply connection	Class A
FCC 47 CFR Part 15	Supply connection	Class A
EN 61000-6-4	Supply connection	Fulfilled
EN 55032	Telecommunication connections	Class A
EN 61000-6-4	Telecommunication connections	Fulfilled
<b>EMC interference immunity</b>		
<b>Electrostatic discharge</b>		
EN 61000-4-2	Contact discharge	±6 kV
IEEE C37.90.3		
EN 61000-4-2	Air discharge	±8 kV
IEEE C37.90.3		
<b>Electromagnetic field</b>		
EN 61000-4-3		max. 20 V/m
<b>Fast transients (burst)</b>		
EN 61000-4-4	Supply connection	±2 kV
EN 61000-4-4	Data line	±4 kV
<b>Voltage surges - DC supply connection</b>		
EN 61000-4-5	line/ground	±2 kV
EN 61000-4-5	line/line	±1 kV
<b>Voltage surges - data line</b>		
EN 61000-4-5	line/ground	±2 kV
<b>Conducted disturbances</b>		
EN 61000-4-6	150 kHz ... 80 MHz	10 V
<b>Immunity</b>		
IEC 60068-2-6, test Fc	Vibration	5 Hz ... 8.4 Hz with 3.5 mm (0.14 in) amplitude 8.4 Hz ... 150 Hz with 1 g
IEC 60068-2-27, test Ea	Shock	15 g at 11 ms

## 7.4 Network range

<b>10/100/1000 Mbit/s twisted pair port</b>	
Length of a twisted pair segment	max. 100 m (328 ft) (for Cat5e cable)

Table 3: Network range: 10/100/1000 Mbit/s twisted pair port

## 7.5 Power consumption/power output

Name	Maximum power consumption	power output
OCTOPUS 8TX-EEC	4.2 W	14.3 Btu (IT)/h
OCTOPUS 8TX PoE-EEC	44 W	47.8 Btu (IT)/h
OCTOPUS 8TX-EEC-M	6 W	20.0 Btu (IT)/h

## 7.6 Signal contact

This applies to the following device variants only:

- ▶ OCTOPUS 8TX-EEC-M

Signal contact	
Connection type	5-pin, "A"-coded M12 plug
	Tightening torque 0.51 Nm (4.5 lb-in)
Nominal value	$I_{\max} = 1 \text{ A}$ at $U_{\max} = 30 \text{ V AC}$ (resistive load) $I_{\max} = 1 \text{ A}$ at $U_{\max} = 60 \text{ V DC}$ (resistive load) <b>according to the UL Standards:</b> $I_{\max} = 0.5 \text{ A}$ at $U_{\max} = 30 \text{ V AC}$ (resistive load) $I_{\max} = 1 \text{ A}$ at $U_{\max} = 30 \text{ V DC}$ (resistive load) $I_{\max} = 0,3 \text{ A}$ at $U_{\max} = 60 \text{ V DC}$ (resistive load)

Table 4: Signal contact: OCTOPUS 8TX-EEC-M

## 8 Scope of delivery, order numbers and accessories

### ■ Scope of delivery

**Note:** The connector ELWIK A 5012 PG7 (933 175-100) supports a temperature range from -25 °C to +70 °C (-13 °F to +158 °F). It may thus limit the application range of the overall system.

You can obtain special sockets for the total temperature range and with the degree of protection IP65/67 and on request.

Device	Scope of delivery
OCTOPUS 8TX-EEC	▶ Device
OCTOPUS 8TX PoE-EEC	▶ 1 × Transport protection cap for supply voltage connection
OCTOPUS 8TX-EEC-M	▶ 7 × Protection screws for M12 socket, plastic
	▶ 15 × Indicator plates
	▶ ELWIK A 5012 PG7 connector (5-pin M12 socket for power supply)
	▶ Safety and general information sheet

### ■ Order number

Device	Order number
OCTOPUS 8TX-EEC	942 150-001
OCTOPUS 8TX PoE-EEC	942 151-001
OCTOPUS 8TX-EEC-M-2S	942 301-001
OCTOPUS 8TX-EEC-M-2A	942 301-002

### ■ Accessories

Note that products recommended as accessories may have different characteristics to those of the device, which may limit the application range of the overall system. For example, if you add an accessory with IP20 to a device with IP67, the IP of the overall system is reduced to IP20.

**Note:** To sustain the IP65/67/69K suitability for your device, exclusively use accessories with degree of protection IP65/67/69K. Seal all unused connections and ports with protection screws. To comply with IPX9K suitability, use metal protection screws and cover the rear side of the device.

Name	Order number
AutoConfiguration Adapter ACA21-M12 (EEC)	943 913-003
AutoConfiguration Adapter ACA22-M12 (EEC)	942 125-001
AutoConfiguration Adapter ACA22-M12-C (EEC)	942 306-001
M12 connector, 4-pin, "D"-coded	934 445-001

<b>Name</b>	<b>Order number</b>
M12-USB adapter cable (for connecting the ACA with a computer)	942 199-001
Adapter cable M12 5-pin male to USB (for configuration of OCTOPUS 8TX-EEC-M devices)	942 309-001
Protection screw for M12 socket, plastic, IP65/67 (25 pieces)	942 057-002
Protection screw for M12 socket, metal, IP65/67/69K (25 pieces)	942 057-001
Connector ELWIK A 5012 PG7 (5-pin M12 socket for voltage supply)	933 175-100
Transition M12 "D"-coded to RJ45	934 498-001
Connection cable with M12 connectors, 4-pin, "D"-coded	
Length 2 m	934 578-001
Length 5 m	934 578-002
Length 10 m	934 578-003
Network management software Industrial HiVision	943 156-xxx
OPC Server software HiOPC	943 055-001



## 9 Underlying technical standards

Name	
FCC 47 CFR Part 15	Code of Federal Regulations
UL/IEC 61010-1	Safety requirements for electrical equipment for measurement, control and laboratory use
UL/IEC 61010-2-201	Safety requirements for electrical equipment for measurement, control and laboratory use - Part 2-201: Particular requirements for control equipment.
CAN/CSA 22.2 No. 61010-1	Safety requirements for electrical equipment for measurement, control and laboratory use
CAN/CSA 22.2 No. 61010-2-201	Safety requirements for electrical equipment for measurement, control and laboratory use - Part 2-201: Particular requirements for control equipment.
ISA-12.12.01	Nonincendive Electrical Equipment for Use in Class I and II, Division 2 and Class III, Divisions 1 and 2 Hazardous (Classified) Locations.
DNV-CG-0339	Environmental test specification for electrical, electronic and programmable equipment and systems.
RCM	Australian Regulatory Compliance Mark (RCM) Australian Radiocommunications Standard 2008, Radiocommunications Act 1992
UN/ECE Regulation No. 10, Amendment No. 05, suppl. 01	E type approval for use in vehicles (EMC)
UN/ECE Regulation No. 118, Amendment No. 03, suppl. 01	E type approval for use in vehicles (burning behaviour)
EN 45545-2	Railway applications - Fire protection on railway vehicles - Part 2: Requirements for fire behavior of materials and components.
EN 50121-4	Railway applications – EMC – Emission and immunity of the signaling and telecommunications apparatus (Rail Trackside)
EN 50155	Railway applications – Electronic equipment used on rolling stock
EN 55032	Electromagnetic compatibility of multimedia equipment – Emission Requirements
IEC 60950-1	Information technology equipment – Safety – Part 1: General requirements
EN 61131-2	Programmable controllers – Part 2: Equipment requirements and tests
IEEE 802.1D	Switching, GARP, GMRP, Spanning Tree
IEEE 802.1D	Media access control (MAC) bridges (includes IEEE 802.1p Priority and Dynamic Multicast Filtering, GARP, GMRP)
IEEE 802.1Q	Virtual LANs (VLANs, MRP, Spanning Tree)
IEEE 802.1Q	Virtual Bridged Local Area Networks (VLAN Tagging, GVRP)
IEEE 802.3	Ethernet

The device has an approval based on a specific standard exclusively if the approval indicator appears on the device casing.

The device generally fulfills the technical standards named in their current versions.

# A Further support

## Technical questions

For technical questions, please contact any Hirschmann dealer in your area or Hirschmann directly.

You find the addresses of our partners on the Internet at <http://www.hirschmann.com>.

A list of local telephone numbers and email addresses for technical support directly from Hirschmann is available at <https://hirschmann-support.belden.com>.

This site also includes a free of charge knowledge base and a software download section.

## Customer Innovation Center

The Customer Innovation Center is ahead of its competitors on three counts with its complete range of innovative services:

- ▶ Consulting incorporates comprehensive technical advice, from system evaluation through network planning to project planning.
- ▶ Training offers you an introduction to the basics, product briefing and user training with certification.  
You find the training courses on technology and products currently available at <https://www.belden.com/solutions/customer-innovation-center>.
- ▶ Support ranges from the first installation through the standby service to maintenance concepts.

With the Customer Innovation Center, you decide against making any compromises in any case. Our client-customized package leaves you free to choose the service components you want to use.

Internet:

<https://www.belden.com/solutions/customer-innovation-center>

## B Open Source Software used in the product

The product contains, among other things, Open Source Software files, as defined below, developed by third parties and licensed under an Open Source Software license.

These Open Source Software files are protected by copyright. Your right to use the Open Source Software is governed by the relevant applicable Open Source Software license conditions

Your compliance with those license conditions will entitle you to use the Open Source Software as foreseen in the relevant license. In the event of conflicts between other Hirschmann Automation and Control GmbH license conditions applicable to the product and the Open Source Software license conditions, the Open Source Software conditions shall prevail. The Open Source Software is provided royalty-free (i.e. no fees are charged for exercising the licensed rights). Open Source Software contained in this product and the respective Open Source Software licenses are stated below.

If Open Source Software contained in this product is licensed under GNU General Public License (GPL), GNU Lesser General Public License (LGPL), Mozilla Public License (MPL) or any other Open Source Software license, which requires that source code is to be made available and such source code is not already delivered together with the product, you can order the corresponding source code of the Open Source Software from Hirschmann Automation and Control GmbH - against payment of the shipping and handling charges - for a period of at least 3 years since purchase of the product. Please send your specific request, within three years of the purchase date of this product, together with the name and ID number of the product to be found at the label of the product to:

Hirschmann Automation and Control GmbH  
Head of R&D  
Stuttgarter Str. 45-51  
72654 Neckartenzlingen  
Germany

### **Warranty regarding further use of the Open Source Software**

Hirschmann Automation and Control GmbH provides no warranty for the Open Source Software contained in this product, if such Open Source Software is used in any manner other than intended by Hirschmann Automation and Control GmbH. The licenses listed below define the warranty, if any, from the authors or licensors of the Open Source Software.

Hirschmann Automation and Control GmbH specifically disclaims any warranty for defects caused by altering any Open Source Software or the product's configuration. Any warranty claims against Hirschmann Automation and Control GmbH in the event that the Open Source Software contained in this product infringes the intellectual property rights of a third party are excluded.

Technical support, if any, will only be provided for unmodified software.

### **Software contained in the product**

The following software components are part of the product depending on the product and its feature set:

Component Name: Atmel Advanced Software Framework (ASF)

License: Atmel ASF License

Version: 3.25.0

Source Link: <http://asf.atmel.com/docs/latest/download.html>

Component Name: BSD-style license

License: BSD-style license

Version: R0.09

Source Link: <http://elm-chan.org/fsw/ff/archives.html>

Component Name: ARM Cortex Microcontroller Software Interface Standard (CMSIS)

License: ARM CMSIS License

Version: 3.00

Source Link: <http://packs.download.atmel.com/>

### **The Licenses in Detail**

#### **Atmel Advanced Software Framework (ASF)**

Copyright (c) 2014 Atmel Corporation. All rights reserved.

Redistribution and use in source and binary forms, with or without modification, are permitted provided that the following conditions are met:

- 1) Redistributions of source code must retain the above copyright notice, this list of conditions and the following disclaimer.
- 2) Redistributions in binary form must reproduce the above copyright notice, this list of conditions and the following disclaimer in the documentation and/or other materials provided with the distribution.
- 3) The name of Atmel may not be used to endorse or promote products derived from this software without specific prior written permission.
- 4) This software may only be redistributed and used in connection with an Atmel microcontroller product.

THIS SOFTWARE IS PROVIDED BY ATMEL "AS IS" AND ANY EXPRESS OR IMPLIED WARRANTIES, INCLUDING, BUT NOT LIMITED TO, THE IMPLIED WARRANTIES OF MERCHANTABILITY, FITNESS FOR A PARTICULAR PURPOSE AND NON-INFRINGEMENT ARE EXPRESSLY AND SPECIFICALLY DISCLAIMED. IN NO EVENT SHALL ATMEL BE LIABLE OR ANY DIRECT, INDIRECT, INCIDENTAL, SPECIAL, EXEMPLARY, OR CONSEQUENTIAL DAMAGES (INCLUDING, BUT NOT LIMITED TO, PROCUREMENT OF SUBSTITUTE GOODS OR SERVICES; LOSS OF USE, DATA, OR PROFITS; OR BUSINESS INTERRUPTION) HOWEVER CAUSED AND ON ANY THEORY OF LIABILITY, WHETHER IN CONTRACT, STRICT LIABILITY, OR TORT (INCLUDING NEGLIGENCE OR OTHERWISE) ARISING IN ANY WAY OUT OF THE USE OF THIS SOFTWARE, EVEN IF ADVISED OF THE POSSIBILITY OF SUCH DAMAGE.

### **FAT file system (FatFs)**

FatFs - FAT file system module R0.09  
(C)ChaN, 2011

FatFs module is a generic FAT file system module for small embedded systems. This is a free software that opened for education, research and commercial developments under license policy of following terms.

Copyright (C) 2011, ChaN, all right reserved.

The FatFs module is a free software and there is NO WARRANTY. No restriction on use. You can use, modify and redistribute it for personal, non-profit or commercial products UNDER YOUR RESPONSIBILITY. Redistributions of source code must retain the above copyright notice.

### **ARM Cortex Microcontroller Software Interface Standard (CMSIS)**

Copyright (C) 2009-2012 ARM Limited. All rights reserved.

ARM Limited (ARM) is supplying this software for use with Cortex-M processor based microcontrollers. This file can be freely distributed within development tools that are supporting such ARM based processors.

THIS SOFTWARE IS PROVIDED "AS IS" NO WARRANTIES, WHETHER EXPRESS, IMPLIED OR STATUTORY, INCLUDING, BUT NOT LIMITED TO, IMPLIED WARRANTIES OF MERCHANTABILITY AND FITNESS FOR A PARTICULAR PURPOSE APPLY TO THIS SOFTWARE. ARM SHALL NOT, IN ANY CIRCUMSTANCES, BE LIABLE FOR SPECIAL, INCIDENTAL, OR CONSEQUENTIAL DAMAGES, FOR ANY REASON WHATSOEVER.

CMSIS is released under the terms of the end user license agreement ("CMSIS END USER LICENCE AGREEMENT.pdf"). Any user of the software package is bound to the terms and conditions of the end user license agreement.

## END USER LICENCE AGREEMENT FOR THE CORTEX MICROCONTROLLER SOFTWARE INTERFACE STANDARD (CMSIS) SPECIFICATION AND SOFTWARE

THIS END USER LICENCE AGREEMENT (“LICENCE”) IS A LEGAL AGREEMENT BETWEEN YOU (EITHER A SINGLE INDIVIDUAL, OR SINGLE LEGAL ENTITY) AND ARM LIMITED (“ARM”) FOR THE USE OF THE CMSIS SPECIFICATION, EXAMPLE CODE, DSP LIBRARY SPECIFICATION AND DSP LIBRARY IMPLEMENTATION AS SUCH TERMS ARE DEFINED BELOW (COLLECTIVELY, THE “ARM DELIVERABLES”). ARM IS ONLY WILLING TO LICENSE THE ARM DELIVERABLES TO YOU ON CONDITION THAT YOU ACCEPT ALL OF THE TERMS IN THIS LICENCE. BY CLICKING “I AGREE”, OR BY INSTALLING OR OTHERWISE USING OR COPYING THE ARM DELIVERABLES YOU INDICATE THAT YOU AGREE TO BE BOUND BY ALL THE TERMS OF THIS LICENCE. IF YOU DO NOT AGREE TO THE TERMS OF THIS LICENCE, ARM IS UNWILLING TO LICENSE YOU TO USE THE ARM DELIVERABLES AND YOU MAY NOT INSTALL, USE OR COPY THE ARM DELIVERABLES.

“CMSIS Specification” means any documentation and C programming language files defining the application programming interface, naming and coding conventions of the Cortex Microcontroller Software Interface Standard (CMSIS) as well as the System View Description (SVD) documentation and associated XML schema file. Notwithstanding the foregoing, “CMSIS Specification” shall not include (i) the implementation of other published specifications referenced in the CMSIS Specification; (ii) any enabling technologies that may be necessary to make or use any product or portion thereof that complies with the CMSIS Specification, but are not themselves expressly set forth in the CMSIS Specification (e.g. compiler front ends, code generators, back ends, libraries or other compiler, assembler or linker technologies; validation or debug software or hardware; applications, operating system or driver software; RISC architecture; processor microarchitecture); (iii) maskworks and physical layouts of integrated circuit designs; or (iv) RTL or other high level representations of integrated circuit designs.

“DSP Library Implementation” means any C programming language source code implementing the functionality of the digital signal processor (DSP) algorithms and the application programming interface as defined in the DSP Library Specification. The DSP Library Implementation makes use of CMSIS application programming interface and therefore is targeted at Cortex-M class processors.

“DSP Library Specification” means the DSP library documentation and C programming language file defining the application programming interface of the DSP Library Implementation. Notwithstanding the foregoing, “DSP Library Specification” shall not include (i) the implementation of other published specifications referenced in the DSP Library Specification; (ii) any enabling technologies that may be necessary to make or use any product or portion thereof that complies with the DSP Library Specification, but are not themselves expressly set forth in the DSP Library Specification (e.g. compiler front ends, code generators, back ends, libraries or other compiler, assembler or linker technologies; validation or debug software or hardware; applications, operating system or driver software; RISC architecture; processor microarchitecture); (iii) maskworks and physical layouts of integrated circuit designs; or (iv) RTL or other high level representations of integrated circuit designs.

“Example Code” means any files in C, C++ or ARM assembly programming languages, associated project and configuration files that demonstrate the usage of the CMSIS Specification, the DSP Library Specification and the DSP Library Implementation, for microprocessors or device specific software applications that are for use with microprocessors.

## LICENCE GRANTS.

1.1 ARM hereby grants to you, subject to the terms and conditions of this Licence, a non-exclusive, nontransferable licence, to;

(i) use and copy the CMSIS Specification for the purpose of developing, having developed, manufacturing, having manufactured, offering to sell, selling, supplying or otherwise distributing products that comply with the CMSIS Specification, provided that you preserve any copyright notices which are included with, or in, the CMSIS Specification and provided that you do not use ARM's name, logo or trademarks to market such products;

(ii) use, copy, and modify (solely to the extent necessary to incorporate the whole or any part of the DSP Library Specification into your documentation), the DSP Library Specification, for the purpose of developing, having developed, manufacturing, having manufactured, offering to sell, selling, supplying or otherwise distributing products that comply with the DSP Library Specification, and distribute and have distributed any documentation created by or for you that has been derived from the DSP Library Specification with such products, provided that you preserve any copyright notices which are included with, or in, the DSP Library Specification and provided that you do not use ARM's name, logo or trademarks to market such products;

(iii) use, copy, modify and sublicense the Example Code solely for the purpose of developing, having developed, manufacturing, having manufactured, offering to sell, selling, supplying or otherwise distributing products that comply with either or both the CMSIS Specification and the DSP Library Specification, provided that you preserve any copyright notices which are included with, or in, the Example Code and that you do not use ARM's name, logo or trademarks to market such products;

(iv) use, copy and modify (provided that the logical functionality and the application programming interface of the DSP Library Implementation are maintained) the DSP Library Implementation, solely for the purposes of developing; (a) software applications for use with microprocessors manufactured or simulated under licence from ARM (“Software Applications”); and (b) tools that are designed to develop software programs for use with microprocessors manufactured or simulated under licence from ARM (“Tools”); and

(v) subject to clause 1.1(vi) below; (a) distribute and sublicense the use of the DSP Library Implementation (including any modified forms thereof created under Clause 1.1(iv) above) in binary or source format, solely as incorporated into Software Library Applications and Tools to third parties; and (b) sublicense to such third parties the right to use and copy the Tools for the purposes of developing and distribute software programs for use with microprocessors manufactured or simulated under licence from ARM.

(vi) **CONDITIONS ON REDISTRIBUTION:** If you choose to redistribute the whole or any part of the DSP Library Implementation as incorporated into Software Library Applications or Tools, you agree to; (a) ensure that the DSP Library Implementation is licensed for use only as part of Software Library Applications and Tools and only for use with microprocessors manufactured or simulated under licence from ARM; (b) not to use ARM's name, logo or trademarks to market Software Applications and Tools; and (c) include valid copyright notices on Software Applications and Tools, and preserve any copyright notices which are included with, or in, the DSP Library Implementation.

## 2. RESTRICTIONS ON USE OF THE ARM DELIVERABLES.

**PERMITTED USERS:** The ARM Deliverables shall be used only by you (either a single individual, or single legal entity) your employees, or by your on-site bona fide sub-contractors for whose acts and omissions you hereby agree to be responsible to ARM for to the same extent as you are for your employees, and provided always that such sub-contractors; (i) are contractually obligated to use the ARM Deliverables only for your benefit, and (ii) agree to assign all their work product and any rights they create therein in the supply of such work to you.



**COPYRIGHT AND RESERVATION OF RIGHTS:** The ARM Deliverables are owned by ARM or its licensors and are protected by copyright and other intellectual property laws and international treaties. The ARM Deliverables are licensed not sold. Except as expressly licensed herein, you acquire no right, title or interest in the ARM Deliverables or any intellectual property therein. In no event shall the licences granted herein be construed as granting you, expressly or by implication, estoppels or otherwise, a licence to use any ARM technology except the ARM Deliverables.

### 3. SUPPORT.

ARM is not obligated to support the ARM Deliverables but may do so entirely at ARM's discretion.

### 4. NO WARRANTY

YOU AGREE THAT THE ARM DELIVERABLES ARE LICENSED "AS IS", AND THAT ARM EXPRESSLY DISCLAIMS ALL REPRESENTATIONS, WARRANTIES, CONDITIONS OR OTHER TERMS, EXPRESS, IMPLIED OR STATUTORY, INCLUDING WITHOUT LIMITATION THE IMPLIED WARRANTIES OF NONINFRINGEMENT, SATISFACTORY QUALITY, AND FITNESS FOR A PARTICULAR PURPOSE. THE ARM DELIVERABLES MAY CONTAIN ERRORS. ARM RESERVES THE RIGHT TO INCORPORATE MODIFICATIONS TO THE ARM DELIVERABLES IN LATER REVISIONS OF THEM, AND TO MAKE IMPROVEMENTS OR CHANGES IN THE ARM DELIVERABLES AT ANY TIME.

### 5. LIMITATION OF LIABILITY

THE MAXIMUM LIABILITY OF ARM TO YOU IN AGGREGATE FOR ALL CLAIMS MADE AGAINST ARM IN CONTRACT, TORT OR OTHERWISE UNDER OR IN CONNECTION WITH THE SUBJECT MATTER OF THIS LICENCE SHALL NOT EXCEED THE GREATER OF (I) THE TOTAL OF SUMS PAID BY YOU TO ARM (IF ANY) FOR THIS LICENCE AND (II) US\$10.00. THE LIMITATIONS, EXCLUSIONS AND DISCLAIMERS IN THIS LICENCE SHALL APPLY TO THE MAXIMUM EXTENT ALLOWED BY APPLICABLE LAW.

### 6. U.S. GOVERNMENT END USERS

US Government Restrictions: Use, duplication, reproduction, release, modification, disclosure or transfer of this commercial product and accompanying documentation is restricted in accordance with the terms of this Licence.

### 7. TERM AND TERMINATION

7.1 This Licence shall remain in force until terminated in accordance with the terms of Clause 7.2 or Clause 7.3 below.

7.2 Without prejudice to any of its other rights if you are in breach of any of the terms and conditions of this Licence then ARM may terminate this Licence immediately upon giving written notice to you. You may terminate this Licence at any time.

7.3 This Licence shall immediately terminate and shall be unavailable to you if you or any party affiliated to you asserts any patents against ARM, ARM affiliates, third parties who have a valid licence from ARM for the ARM Deliverables, or any customers or distributors of any of them based upon a claim that your (or your affiliate) patent is Necessary to implement the CMSIS Specification or DSP Library Specification. In this Licence; (i) "affiliate" means any entity controlling, controlled by or under common control with a party (in fact or in law, via voting securities, management control or otherwise) and "affiliated" shall be construed accordingly; (ii) "assert" means to allege infringement in legal or administrative proceedings, or proceedings before any other competent trade, arbitral or international authority; (iii) "Necessary" means with respect to any claims of any patent, those claims which, without the appropriate permission of the patent owner, will be infringed when implementing the CMSIS Specification or DSP Library Specification because no alternative, commercially reasonable, noninfringing way of implementing the CMSIS Specification or DSP Library Specification is known.

7.4 Upon termination of this Licence, you shall stop using the ARM Deliverables and destroy all copies of the ARM Deliverables in your possession. The provisions of clauses 5, 6, 7, and 8 shall survive termination of this Licence.

## 8. GENERAL.

This Licence is governed by English Law. Except where ARM agrees otherwise in a written contract signed by you and ARM, this is the only agreement between you and ARM relating to the ARM Deliverables and it may only be modified by written agreement between you and ARM. Except as expressly agreed in writing, this Licence may not be modified by purchase orders, advertising or other representation by any person. If any clause or sentence in this Licence is held by a court of law to be illegal or unenforceable the remaining provisions of this Licence shall not be affected thereby. The failure by ARM to enforce any of the provisions of this Licence, unless waived in writing, shall not constitute a waiver of ARM's rights to enforce such provision or any other provision of this Licence in the future. This Licence may not be assigned without the prior written consent of ARM.

ARM contract reference LEC-PRE-00489-V6.0

06 December, 2010





**HIRSCHMANN**

---

A **BELDEN** BRAND