

## User Manual

### Installation

### MAMMUTHUS Access Layer & Distribution Layer Switch

### MTS2600/2700/2800 Family

### MAMMUTHUS Power Module – MTM2800-PSU120

### MTM2700-PSU500/PSU120/PSU880

### MAMMUTHUS Media Module – MTM2700-2X/MTM2800-2X



MTS2624-4X-B



MTS2648-6X-B



MTS2724-4X-FP-S



MTS2724-6X-MP-E



MTS2748-6X-MP-E



MTS2848TF-4X-E

Even if not specifically stated, the copyrighted trademark names in this manual shall not be deemed free of charge in the sense of the trademark and trade name protection act and thus freely available to anyone.

© 2020-2023 Belden Singapore Pte. Ltd.

Both the manual and software are protected by copyright. All rights reserved. All or any part of this manual shall be prohibited from being reproduced, copied, translated or converted into any electronic media or machine-scannable form, except in the case that you make a copy of the software for your own use.

The performance characteristics described herein shall be binding only upon the express consent of the parties at the time of signing the contract. This paper is produced by Belden within its capacity. Belden reserves the right to change the contents of this manual without prior notice. Belden does not guarantee the correctness or accuracy of the information in this manual.

Belden shall not be liable for damages caused by the use of network components or related operating software. And the conditions of use specified in the license contract are referred to in this manual.

You may access the latest version of this manual at the product website of Hirschmann IT:  
<https://catalog.belden.com>

# Contents

<b>Important Information</b>	<b>6</b>
<b>Safety instructions</b>	<b>8</b>
<b>About this manual</b>	<b>14</b>
<b>Key</b>	<b>15</b>
<b>Description</b>	<b>16</b>
<b>1.1 General device description</b>	<b>16</b>
<b>1.2 Device name and product code</b>	<b>22</b>
1.2.1 Basic device	22
1.2.2 Power module	23
1.2.3 Media module	23
<b>1.3 Device views</b>	<b>24</b>
1.3.1 MTS2624-4X-B	24
1.3.2 MTS2648-6X-B	25
1.3.3 MTS2724-4X-FP-S	26
1.3.4 MTS2724-6X-MP-E	27
1.3.5 MTS2748-6X-MP-E	28
1.3.6 MTS2824-4X-S	29
1.3.7 MTS2824-6X-E	30
1.3.8 MTS2824F-4X-S	31
1.3.9 MTS2832TF-4X-E	32
1.3.10 MTS2848-6X-E	33
1.3.11 MTS2848-6X-S	34
1.3.12 MTS2848TF-4X-E	35
1.3.13 Power module	36
1.3.14 Media module	37
<b>1.4 Power supply</b>	<b>38</b>
<b>1.5 Ethernet ports</b>	<b>39</b>
1.5.1 1000 Mbit/s F/O port	39
1.5.2 10 Gbit/s F/O port	39
1.5.3 10/100/1000 Mbit/s twisted pair port	39
1.5.4 PoE(+) support	40
1.5.5 Out-of-band management port	40
<b>1.6 Display elements</b>	<b>41</b>
1.6.1 Device status	41

1.6.2	Port status	42
<b>1.7</b>	<b>Management interfaces</b>	<b>43</b>
1.7.1	DC0 interface (external management)	43
1.7.2	USB interface	43
<b>1</b>	<b>Installation</b>	<b>44</b>
2.1	Checking the package contents	44
2.2	Installing the power module (optional)	44
2.3	Installing and grounding the device	45
2.3.1	Installing the device in a switch cabinet	45
2.3.2	Installing the device on a vertical flat surface	48
2.3.3	Grounding the device	49
2.4	Installing the SFP transceiver (optional)	50
2.5	Operating the device	51
2.6	Connecting data cables	51
2.7	Filling out the inscription Label	52
<b>2</b>	<b>Making basic settings</b>	<b>53</b>
<b>3</b>	<b>Monitoring the ambient air temperature</b>	<b>54</b>
<b>4</b>	<b>Maintenance and service</b>	<b>55</b>
<b>5</b>	<b>Disassembly</b>	<b>56</b>
6.1	Removing the power module (optional)	56
6.2	Removing the media module	56
6.3	Removing the SFP transceiver (optional)	57
6.4	Removing the device	58
6.4.1	Removing the device from a vertical flat surface	58
6.4.2	Removing the device from the switch cabinet	58
<b>6</b>	<b>Technical data</b>	<b>59</b>
7.1	General technical data	59
7.2	Dimension drawings	61
7.3	Electromagnetic compatibility (EMC)	79
7.4	Immunity	81
7.5	Network range	82

<b>7.6</b>	<b>Power consumption/power output</b>	<b>83</b>
<b>7</b>	<b>Scope of delivery, order number, and accessories</b>	<b>84</b>
<b>8</b>	<b>Underlying technical standards</b>	<b>86</b>
<b>A</b>	<b>Further support</b>	<b>87</b>

# Important Information

**Note:** Read these instructions carefully, and familiarize yourself with the device before trying to install, operate, or maintain it. The following notes may appear throughout this documentation or on the device. These notes warn of potential hazards or call attention to information that clarifies or simplifies a procedure.

## ■ Symbol explanation



This is a general warning symbol. This symbol alerts you to potential personal injury hazards. Observe all safety notes that follow this symbol to avoid possible injury or death.



If this symbol is displayed in addition to a safety instruction of the type “Danger” or “Warning”, it means that there is a danger of electric shock and failure to observe the instructions will inevitably result in injury.



This symbol indicates the danger of hot surfaces on the device. In connection with safety instructions, non-observance of the instructions will inevitably result in injuries.



## **DANGER**

**DANGER** draws attention to an immediately dangerous situation, which will **inevitably** result in a serious or fatal accident if not observed.



## **WARNING**

**WARNING** indicates a potentially hazardous situation which, if not avoided, could result in death or serious injury.



## **CAUTION**

**CAUTION** indicates a possible danger which, if not avoided, **may** result in minor injuries.

# **NOTICE**

**NOTICE** provides information about procedures that do not involve the risk of injury.

# Safety instructions



## WARNING

### UNCONTROLLED MACHINE ACTIONS

To avoid uncontrolled machine actions caused by data loss, configure all the data transmission devices individually.

Before you start any machine which is controlled via data transmission, be sure to complete the configuration of all data transmission devices.

**Failure to follow this instruction can result in death, serious injury, or device damage.**

### ■ General safety instructions

You operate this device with electricity. Improper usage of the device entails the risk of physical injury or significant property damage. The proper and safe operation of this device depends on proper handling during transportation, proper storage and installation, and careful operation and maintenance procedures.

- Before connecting any cable, read this document, and the safety instructions and warnings.
- Operate the device with undamaged components exclusively.
- The device is free of any service components. In case of a damaged or malfunctioning device, turn off the supply voltage and return the device to Hirschmann IT for inspection.

### ■ Qualification requirements for personnel

- Only allow qualified personnel to work on the device.  
Qualified personnel have the following characteristics:
  - ▶ Qualified personnel are properly trained. Training as well as practical knowledge and experience make up their qualifications. This is the prerequisite for grounding and labeling circuits, devices, and systems in accordance with current standards in safety technology.
  - ▶ Qualified personnel are aware of the dangers that exist in their work.
  - ▶ Qualified personnel are familiar with appropriate measures against these hazards in order to reduce the risk for themselves and others.
  - ▶ Qualified personnel receive training on a regular basis.



## Certified usage

Only use the device for those purposes specified in the catalog and in the technical description. Only operate the device with external devices and components that are recommended and permitted by the manufacturer. The proper and safe operation of this product depends on proper handling during transport, proper storage, assembly and installation, and conscientious operation and maintenance procedures.

### ■ National and international safety regulations

Verify that the electrical installation meets local or nationally applicable safety regulations.

### ■ Ensure the integrity and consistency

- Check the bond on the packaging to assure it is sealed and not tampered by unauthorized party.
- Verify serial number of delivered products to make sure it is unified with a hardcopy serial number list provided by manufacturer. If it is necessary, please contact Belden representative to obtain a softcopy serial number list from manufacturer for double check.

### ■ Requirements for connecting electrical wires

Before connecting the electrical wires, **always** verify that the requirements listed are complied with.

#### The following requirements apply without restrictions:

- ▶ The electrical wires are voltage-free.
- ▶ The cables used are permitted for the temperature range of the application case.
- ▶ Connect the ground screw on the back of the device to the protective conductor before setting up other connections. When to remove connections, the protective conductor is the last to be removed.
- ▶ Exclusively switch on the device when it is installed.
- ▶ Relevant for North America:  
Use 60 °C / 75 °C (140 °F / 167 °F) or 75 °C (167 °F) copper (Cu) wires only.

*Table 1: Requirements for connecting electrical wires*

## ■ Requirements for connecting the supply voltage

The following requirements apply without restrictions:

### All variants

All of the following requirements are complied with:

- ▶ The supply voltage corresponds to the voltage specified on the type of plate of the device.
- ▶ The power supply conforms to overvoltage category I or II.
- ▶ The power supply has an easily accessible disconnecting device (for example a switch or a plug). This disconnecting device is clearly identified. So in the case of an emergency, it is clear which disconnecting device belongs to which power supply cable.
- ▶ When to connect a power supply voltage with a protective conductor: first connect the protective conductor, and then the power supply voltage. If the device contains such a second power supply voltage connection module: first connect the protective conductor, and then the power supply voltage.
- ▶ Supply with DC voltage: The wire diameter of the power supply cable is at least 1 mm<sup>2</sup> (North America: AWG16) on the supply voltage input.
- ▶ Supply with AC voltage: The wire diameter of the power supply cable is at least 0.75 mm<sup>2</sup> (North America: AWG18) on the supply voltage input.
- ▶ The cross-section of the ground conductor is the same size as or bigger than the cross-section of the power supply cables.
- ▶ The power supply cable is suitable for the voltage, the current and the physical load.

Table 2: Requirements for connecting the supply voltage

### ■ Shielding ground

The shielding ground of the connectable twisted pair cable is connected to the ground connection as a conductor.

Beware of possible short circuits when connecting a cable section with conductive shielding braiding.

### ■ Safe grounding

Make sure you ground the devices assembled in the switch cabinet safely. In particular, check the supply voltage connections if they are not connected directly to the supply cable (for example, when using power strips).

### ■ ESD guide

These modules are equipped with electrostatic sensitive components.

If the connection is touched, these sensitive components may be

damaged or their service life shortened by electric field or charge balance effects. You may find information about electrostatic hazard components in DIN EN 61340-5-1 (2007-08) and DIN EN 61340-5-2 (2007-08).

### ■ **Device casing**

Only technicians authorized by the manufacturer are allowed to open the enclosure.

- Keep the cooling fins free to help ensure good air circulation.
- Verify that there is at least 10 cm (4 in) of space around the cooling fins of the casing.
- Do not touch the housing during operation or shortly after switching off the device. Hot surfaces can cause injury.
- Install the device horizontally in the cabinet or vertically on a flat surface. Operating the device as a table unit is inadmissible.  
See ["Installing and grounding the device" on page 45](#)
- Operate the device at the maximum ambient air temperature and in stacking: when to install the device, confirm that there is at least one available rack space that is approximately 5 cm (2 in) above the device to allow heat to escape through the enclosure of the device.
- If you operate the device in a 19" switch cabinet: install the slide / rails to support the weight of the device.

### ■ **Installation site requirements**

Operate the device at the specified ambient temperature (temperature of the ambient air at a distance of 5 cm (2 in) from the device) and at the specified relative humidity exclusively.

- When you are selecting the installation location, make sure you observe the climatic threshold values specified in the technical data.
- Use the device in an environment with a maximum pollution degree that complies with the specifications in the technical data.  
See ["Technical data" on page 59](#)
- Increased ambient temperature: When you are operating the device in a closed switch cabinet or together with other devices in a switch cabinet, the ambient temperature in the switch cabinet can be higher than the ambient temperature in the room. Only install the device in an ambient temperature in line with the maximum ambient temperature specified by the manufacturer:  $t_{max}$ .
- Mechanical stress: Install the device in a switch cabinet in such a way that rules out hazardous conditions due to severe mechanical stress.

## ■ **CE marking**

The labeled devices comply with the regulations contained in the following European directive(s):

▶ **2011/65/EU and 2015/863/EU (RoHS)**

Directive of the European Parliament and of the Council on the restriction of the use of certain hazardous substances in electrical and electronic device.

▶ **2014/30/EU (EMC)**

Directive of the European Parliament and of the Council on the harmonisation of the laws of the Member States relating to electromagnetic compatibility.

▶ **2014/35/EU**

Directive of the European Parliament and of the Council on the harmonisation of the laws of the Member States relating to the making available on the market of electrical equipment designed for use within certain voltage limits.

In accordance with the above-named EU directive(s), the EU conformity declaration will be at the disposal of the relevant authorities at the following address:

Hirschmann Automation and Control GmbH  
Stuttgarter Str. 45-51  
72654 Neckartenzlingen  
Germany

You find the EU conformity declaration as PDF file for downloading on the Internet at: <https://catalog.belden.com>

**Warning!** This is a class A device. This device can cause interference in living areas, and in this case the operator may be required to take appropriate measures.

**Warning!** When Ethernet cables are used in industrial environments, confirm that they are shielded.

**Note:** The assembly guidelines provided in these instructions must be strictly adhered to in order to observe the EMC threshold values.

## ■ **LED or laser components**

LED or LASER components according to IEC 60825-1 (2014):  
CLASS 1 LASER PRODUCTS  
CLASS 1 LED PRODUCTS

## ■ **FCC note**

### **Supplier's Declaration of Conformity** **47 CFR § 2.1077 Compliance Information**

MTS2600/2700/2800

### **U.S. Contact Information**

Belden – St. Louis  
1 N. Brentwood Blvd. 15th Floor  
St. Louis, Missouri 63105, United States  
Phone: 314.854.8000

This device complies with part 15 of the FCC rules.

Operation is subject to the following two conditions:

- ▶ This device may not cause harmful interference, and
- ▶ This device must accept any interference received, including interference that may cause undesired operation.

This device has been tested and found to comply with the limits for a class A digital device, pursuant to part 15 of the FCC Rules. These limits are designed to provide reasonable protection against interference with the device when used in commercial environments. This device generates, uses and can radiate radio frequency energy and, if not installed and used in accordance with the instructions, may cause harmful interference to radio communications. Use of the device in residential areas can also cause interference, in this case the user is obliged to pay to eliminate such interference.

## ■ **Recycling note**

After usage, this device must be disposed of properly as electronic waste, in accordance with the current disposal regulations of your county, state, and country.

## **About this manual**



The “Installation” user manual contains a device description, safety instructions, a description of the display, and the other information that you need to install the device.

Documentation mentioned in the “User Manual Installation” that is not supplied with your device as a printout can be found as PDF files for downloading on the Internet at: <https://catalog.belden.com>

# Key

The symbols used in this manual have the following meanings:

---

	Listing
	Work step
	Subheading

---

# Description

## 1.1 General device description

MTS2600 switch provides an economic choice for port expansion and LAN extension, which enables customers to choose products with good performance, function and flexibility under the condition of tight budget. Users can extend the Gigabit line speed switching performance from the core to access equipment.

MTS2700 is a PoE switch with comprehensive functions, which can provide up to 30 W power for PoE PD equipment, many L2/L3 functions and security functions can support complex network applications. Modular power supplies can provide fast field maintenance (FRU), and the equipment can ensure normal operation under the environment of 55°C (131°F).

MTS2800 switch provides a complete set of access and convergence solutions, and all models have redundant power configuration. The model is compact, low noise, and can be compatible with 600 mm × 600 mm (23.6 in × 23.6 in) compact cabinet. The switch has a complete L2/L3 feature set, which can provide flexibility, reliability and security for network planning.

### ■ Basic device



MTS2624-4X-B



MTS2648-6X-B





MTS2724-4X-FP-S



MTS2724-6X-MP-E



MTS2748-6X-MP-E



MTS2824-4X-S



MTS2824-6X-E



MTS2824F-4X-S



MTS2848-6X-E



MTS2832TF-4X-E



MTS2848-6X-S



MTS2848TF-4X-E

■ **Power module**



MTM2700-PSU120



MTM2700-PSU500



MTM2700-PSU880



MTM2800-PSU120

**Note:** MTM2700-PSU120, MTM2700-PSU500 and MTM2700-PSU880 can only be used in MTS2724-6X-MP-E and MTS2748-6X-MP-E.  
MTM2800-PSU120 can only be used in MTS2848TF-4X-E.

You may choose 1 or 2 power modules with the same input voltage:

LV / Ethernet power supply (+)

Power modules are provided as accessories.

See "[Order number](#)" on page 84

## ■ Media module



MTM2700-2X

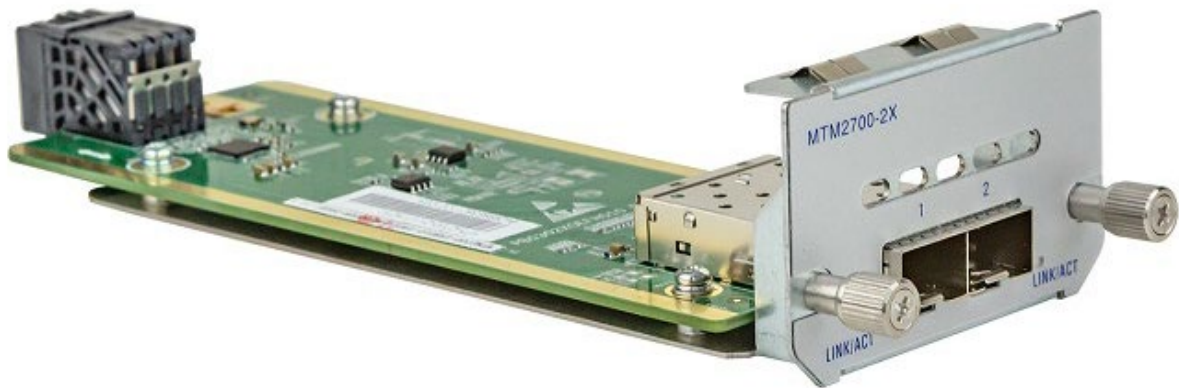

MTM2800-2X

**Note:** MTM2700-2X can only be used in MTS2724-6X-MP-E and MTS2748-6X-MP-E. MTM2800-2X can only be used in MTS2848TF-4X-E.

You can select 1 media module.  
Media modules are provided as accessories.  
See [“Order number” on page 84](#)

## 1.2 Device name and product code

The equipment name corresponds to the product code.

### 1.2.1 Basic device

Order number	Product code	Description
942999847	MTS2624-4X-B	24 × FE/GE TX, 4 × 1/10 Gbit/s SFP+ slot, single fixed power supply, basic software.
942999839	MTS2648-6X-B	48 × FE/GE TX, 6 × 1/10 Gbit/s SFP+ slot, single fixed power supply, basic software.
942999835	MTS2724-4X-FP-S	24 × FE/GE POE/POE+, 4 × 1/10 Gbit/s SFP+ slot, fixed redundant power supply, POE output 380 W, basic software.
942999832	MTS2724-6X-MP-E	24 × FE/GE POE/POE+, 4 × 1/10 Gbit/s SFP+ slot, 1 × extend media module slot, 2 × modular power supply unit slot, advanced software.
942999831	MTS2748-6X-MP-E	48 × FE/GE POE/POE+, 4 × 1/10 Gbit/s SFP+ slot, 1 × extend media module slot, 2 × modular power supply unit slot, advanced software.
942999846	MTS2832TF-4X-E	24 × 100/1000 Mbit/s SFP slot, 8 × FE/GE TX, 4 × 1/10 Gbit/s SFP+ slot, fixed redundant power supply, advanced software.
942999845	MTS2824F-4X-S	24 × 100/1000 Mbit/s SFP slot, 4 × 1/10 Gbit/s SFP+ slot, fixed redundant power supply, basic software.
942999844	MTS2824-4X-S	24 × FE/GE TX, 4 × 1/10 Gbit/s SFP+ slot, fixed redundant power supply, basic software.
942999843	MTS2848-6X-S	48 × FE/GE TX, 6 × 1/10 Gbit/s SFP+ slot, fixed redundant power supply, basic software.
942999842	MTS2824-6X-E	24 × FE/GE TX, 6 × 1/10 Gbit/s SFP+ slot, fixed redundant power supply, advanced software.
942999841	MTS2848-6X-E	48 × FE/GE TX, 6 × 1/10 Gbit/s SFP+ slot, fixed redundant power supply, advanced software.
942999849	MTS2848TF-4X-E	32 × 100/1000 Mbit/s SFP slot, 16 × FE/GE TX, 4 × 1/10 Gbit/s SFP+ slot, fixed redundant power supply, advanced software.

## 1.2.2 Power module

Order number	Product code	Description
942999834	MTM2700-PSU120	AC/DC 120 W power module; AC input 100 V AC ... 240 V AC, 2 A; output 12 V DC, 10 A; No PoE support.
942999833	MTM2700-PSU500	AC/DC 500 W power module; AC input 100 V AC ... 240 V AC, 7 A; output 12 V DC, 10 A, 53.5 V DC, 7 A; PoE support.
942999837	MTM2700-PSU880	AC/DC 880 W power module; AC input 100 V AC ... 240 V AC, 7 A; output 12 V DC, 10 A, 53.5 V DC, 7.1 A (100 V AC ... 165 V AC); 53.5 V DC, 14.2 A (165 V AC ... 240 V AC); PoE support.
942999840	MTM2800-PSU120	AC/DC 120 W power module; AC input 100 V AC ... 240 V AC, 2 A; output 12 V DC, 10 A; No PoE support.

## 1.2.3 Media module

Order number	Product code	Description
942999836	MTM2700-2X	MTS 2700 media module, 2 × 1/10 Gbit/s SFP+ slot.
942999850	MTM2800-2X	MTS 2700 media module, 2 × 1/10 Gbit/s SFP+ slot.

## 1.3 Device views

### 1.3.1 MTS2624-4X-B

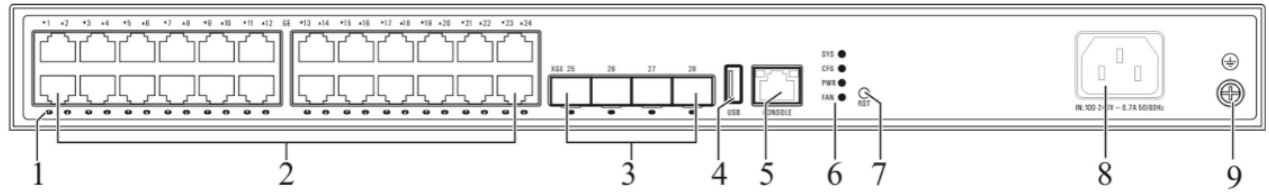

Figure 1: Front view

1	Gigabit electrical Interface status LED
2	Gigabit electrical Interface
3	10 Gigabit optical Interface
4	USB Interface
5	Console port
6	Device status LED
7	Reset button (press and hold for 5 seconds to restart the machine)
8	AC power socket
9	Grounding screw



### 1.3.2 MTS2648-6X-B

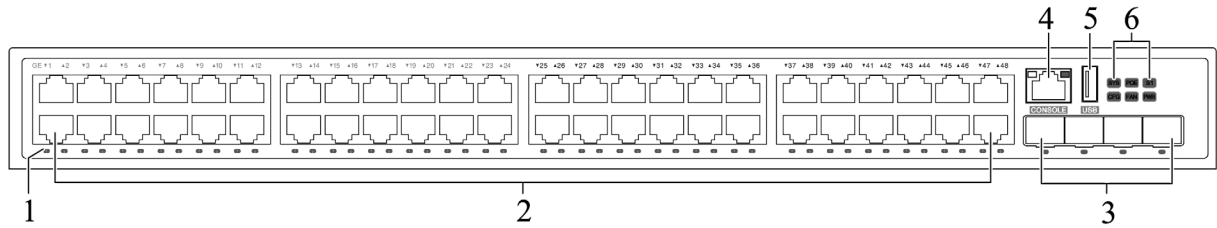

Figure 2: Front view

- |   |   |
|---|---|
| 1 | Gigabit electrical Interface status LED |
| 2 | Gigabit electrical Interface            |
| 3 | 10 Gigabit optical Interface            |
| 4 | Console port                            |
| 5 | USB Interface                           |
| 6 | Device status LED                       |

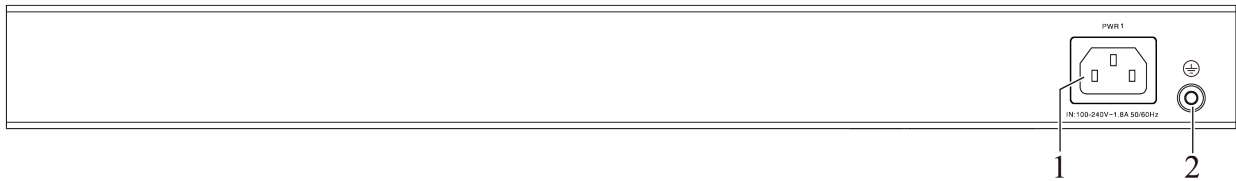

Figure 3: Rear view

- |   |                 |
|---|-----------------|
| 1 | AC power socket |
| 2 | Grounding screw |

### 1.3.3 MTS2724-4X-FP-S

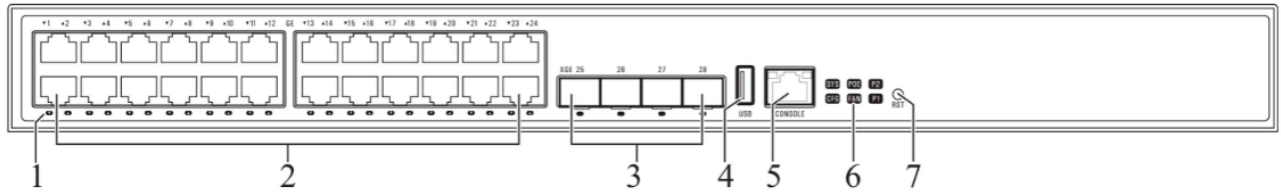

Figure 4: Front view

- |   |  |
|---|--|
| 1 | Gigabit electrical Interface Status LED                            |
| 2 | Gigabit electrical Interface (with PoE function)                   |
| 3 | 10 Gigabit optical Interface                                       |
| 4 | USB Interface  |
| 5 | Console port   |
| 6 | Device status LED  |
| 7 | Reset button (press and hold for 5 seconds to restart the machine) |

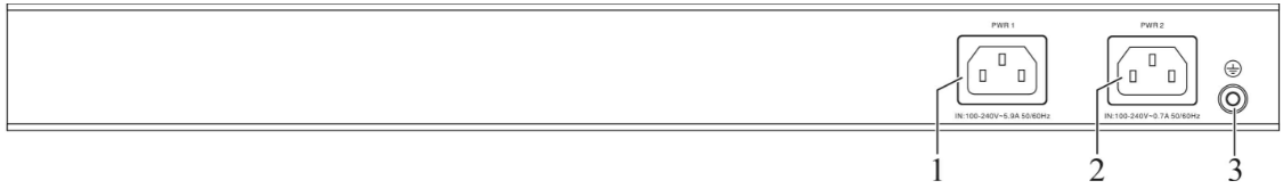

Figure 5: Rear view

- |   |                 |
|---|-----------------|
| 1 | AC power socket |
| 2 | AC power socket |
| 3 | Grounding screw |

### 1.3.4 MTS2724-6X-MP-E

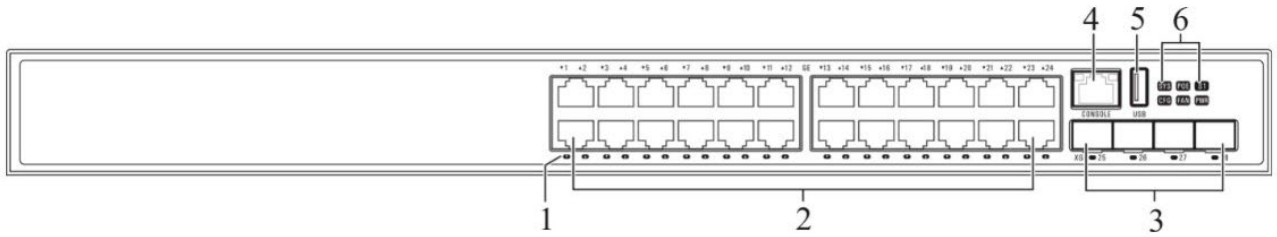

Figure 6: Front view

- |   |  |
|---|--|
| 1 | Gigabit electrical Interface status LED          |
| 2 | Gigabit electrical Interface (with PoE function) |
| 3 | 10 Gigabit optical Interface                     |
| 4 | USB Interface                                    |
| 5 | Console port                                     |
| 6 | Device status LED                                |

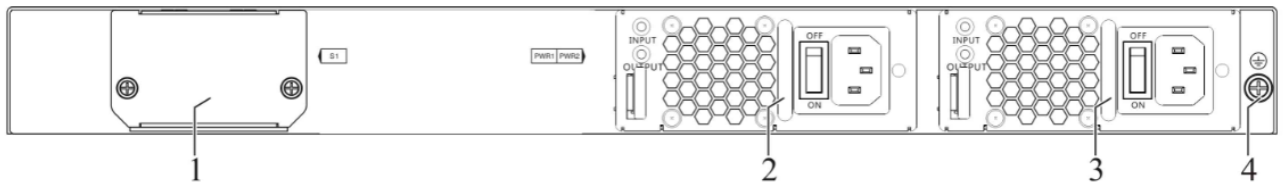

Figure 7: Rear view

- |   |                        |
|---|------------------------|
| 1 | Interface card slot    |
| 2 | Modular power supply 1 |
| 3 | Modular power supply 2 |
| 4 | Grounding screw        |

### 1.3.5 MTS2748-6X-MP-E

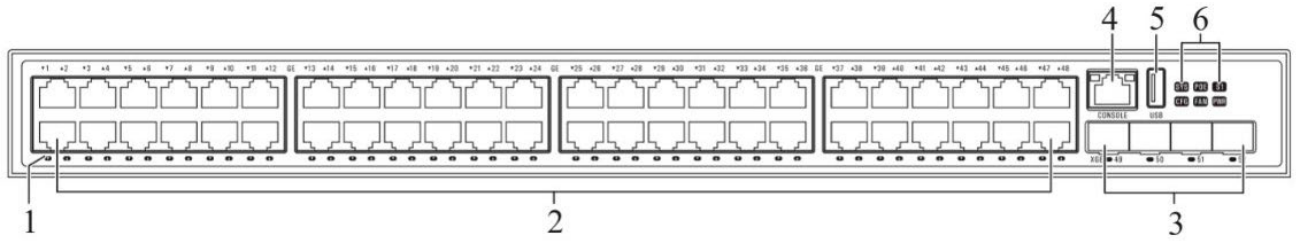

Figure 8: Front View

- |   |  |
|---|--|
| 1 | Gigabit electrical Interface status LED          |
| 2 | Gigabit electrical Interface (with PoE function) |
| 3 | 10 Gigabit optical Interface                     |
| 4 | USB Interface                                    |
| 5 | Console port                                     |
| 6 | Device status LED                                |

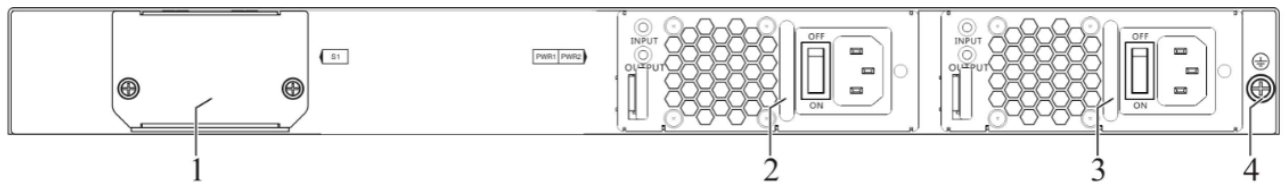

Figure 9: Rear view

- |   |                        |
|---|------------------------|
| 1 | Interface card slot    |
| 2 | Modular power supply 1 |
| 3 | Modular power supply 2 |
| 4 | Grounding screw        |

### 1.3.6 MTS2824-4X-S

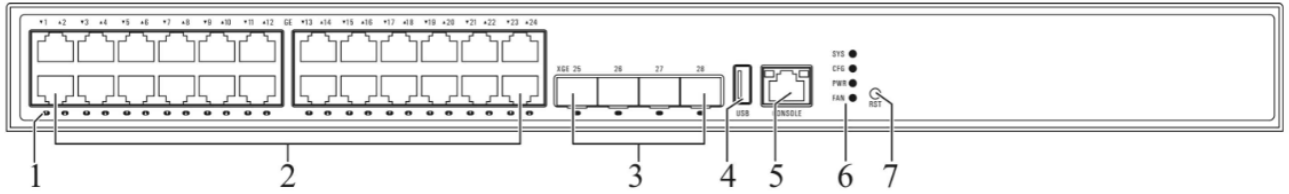

Figure 10: Front view

- |   |  |
|---|--|
| 1 | Gigabit electrical Interface status LED                            |
| 2 | Gigabit electrical Interface                                       |
| 3 | 10 Gigabit optical Interface                                       |
| 4 | USB Interface  |
| 5 | Console port   |
| 6 | Device status LED  |
| 7 | Reset button (press and hold for 5 seconds to restart the machine) |

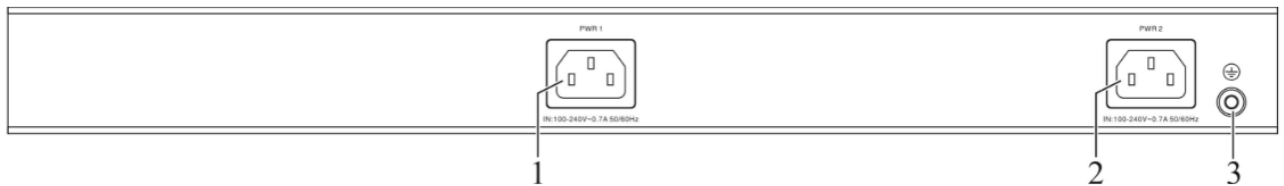

Figure 11: Rear view

- |   |                 |
|---|-----------------|
| 1 | AC power socket |
| 2 | AC power socket |
| 3 | Grounding screw |

### 1.3.7 MTS2824-6X-E

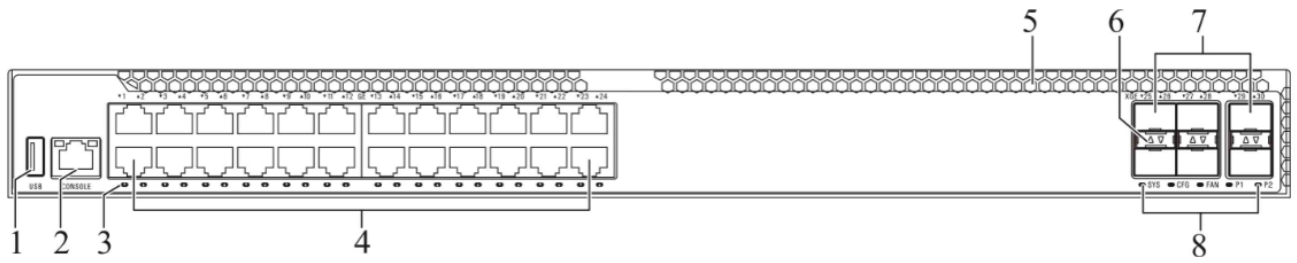

Figure 4: Front view

1	USB Interface
2	Console port
3	Gigabit electrical Interface status LED
4	Gigabit electrical Interface
5	Air Inlet of the device
6	10 Gigabit optical Interface status LED
7	10 Gigabit optical Interface
8	Device status LED

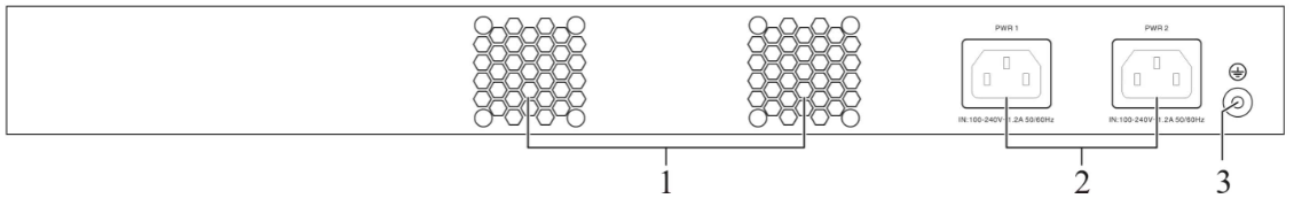

Figure 53: Rear view

1	Air outlet of the device
2	AC power socket
3	Grounding screw

### 1.3.8 MTS2824F-4X-S

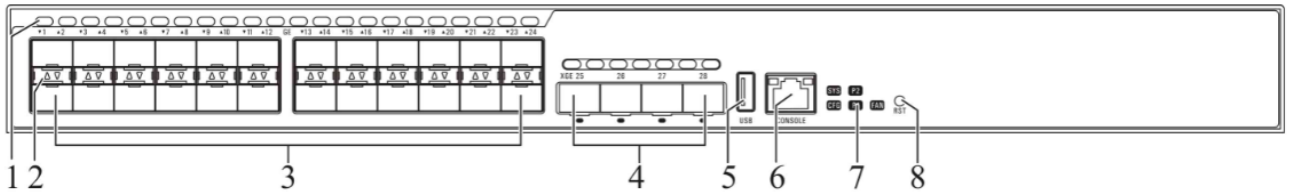

Figure 64: Front view

- |   |  |
|---|--|
| 1 | Air Inlet of the device  |
| 2 | Gigabit optical Interface status LED                               |
| 3 | Gigabit optical Interface  |
| 4 | 10 Gigabit optical Interface                                       |
| 5 | USB Interface  |
| 6 | Console port   |
| 7 | Device status LED  |
| 8 | Reset button (press and hold for 5 seconds to restart the machine) |

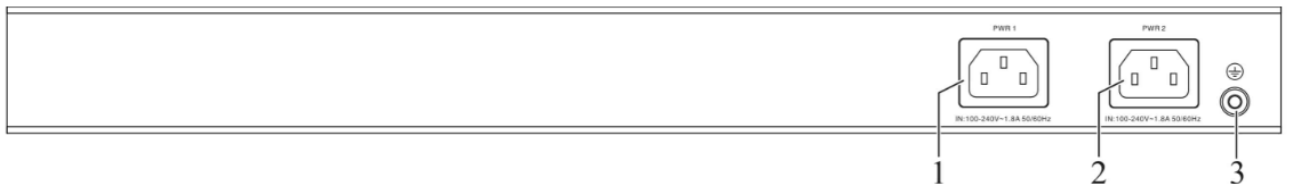

Figure 75: Rear view

- |   |                 |
|---|-----------------|
| 1 | AC power socket |
| 2 | AC power socket |
| 3 | Grounding screw |

### 1.3.9 MTS2832TF-4X-E

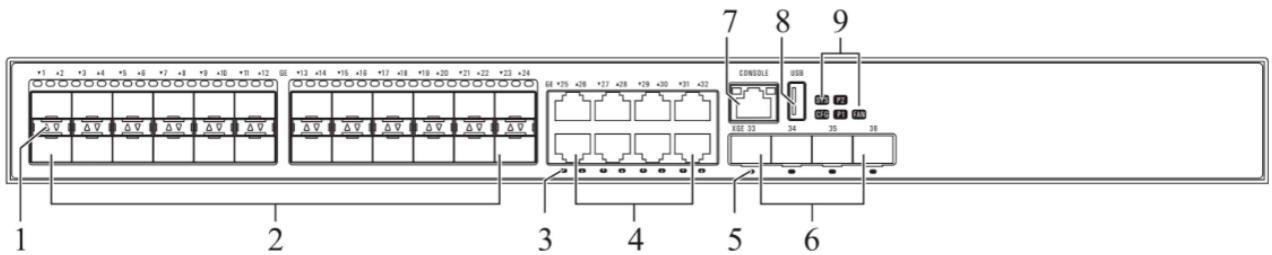

Figure 86: Front view

- |   |   |
|---|---|
| 1 | Gigabit optical Interface status LED    |
| 2 | Gigabit optical Interface               |
| 3 | Gigabit electrical Interface status LED |
| 4 | Gigabit electrical Interface            |
| 5 | 10 Gigabit optical Interface status LED |
| 6 | 10 Gigabit optical Interface            |
| 7 | Console port                            |
| 8 | USB Interface                           |
| 9 | Device status LED                       |

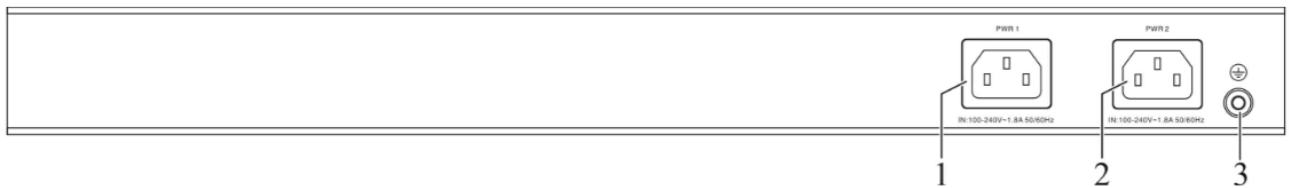

Figure 97: Rear view

- |   |                 |
|---|-----------------|
| 1 | AC power socket |
| 2 | AC power socket |
| 3 | Grounding screw |



### 1.3.10 MTS2848-6X-E

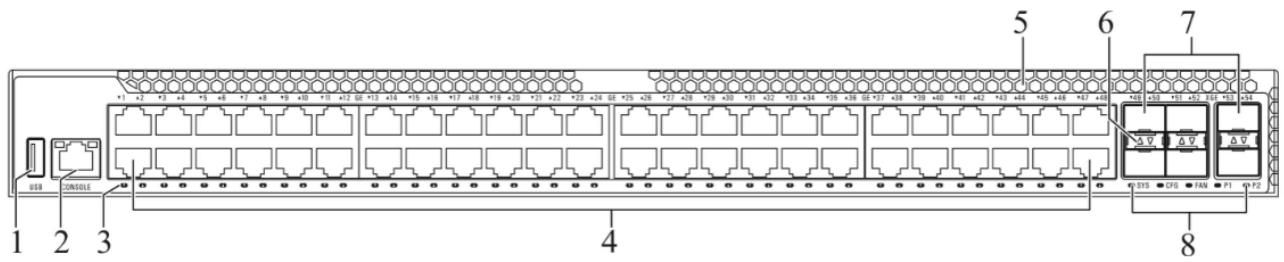

Figure 108: Front view

- |   |   |
|---|---|
| 1 | USB Interface                           |
| 2 | Console port                            |
| 3 | Gigabit electrical Interface status LED |
| 4 | Gigabit electrical Interface            |
| 5 | Air Inlet of the device                 |
| 6 | 10 Gigabit optical Interface status LED |
| 7 | 10 Gigabit optical Interface            |
| 8 | Device status LED                       |

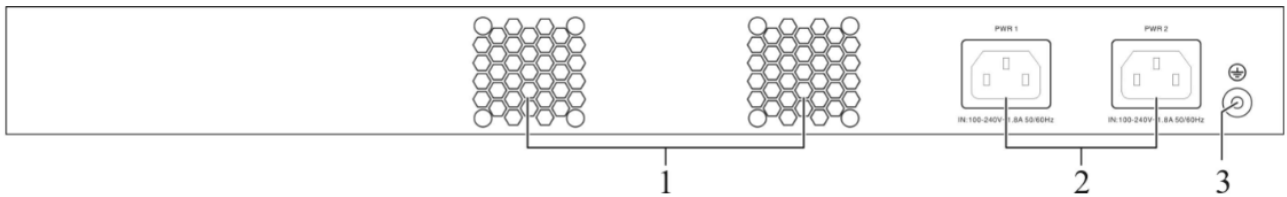

Figure 119: Rear view

- |   |                          |
|---|--------------------------|
| 1 | Air outlet of the device |
| 2 | AC power socket          |
| 3 | Grounding screw          |

### 1.3.11 MTS2848-6X-S

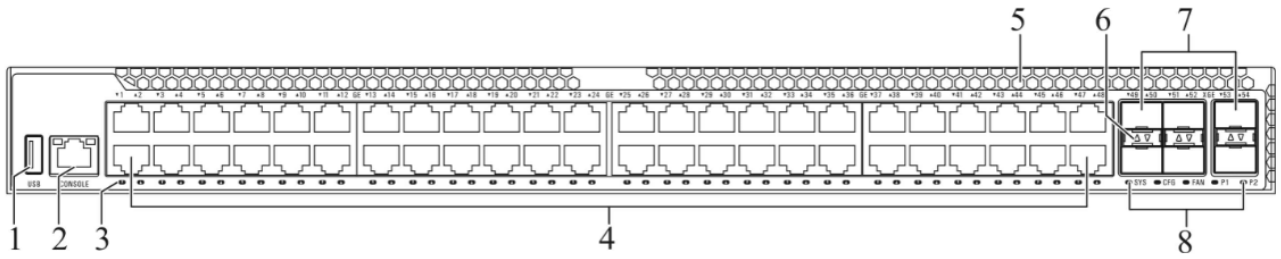

Figure 20: Front view

- |   |   |
|---|---|
| 1 | USB Interface                           |
| 2 | Console port                            |
| 3 | Gigabit electrical Interface status LED |
| 4 | Gigabit electrical Interface            |
| 5 | Air Inlet of the device                 |
| 6 | 10 Gigabit optical Interface status LED |
| 7 | 10 Gigabit optical Interface            |
| 8 | Device status LED                       |

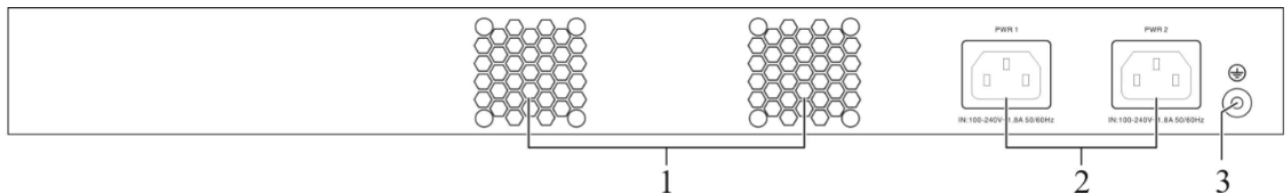

Figure 21: Rear view

- |   |                          |
|---|--------------------------|
| 1 | Air outlet of the device |
| 2 | AC power socket          |
| 3 | Grounding screw          |

### 1.3.12 MTS2848TF-4X-E

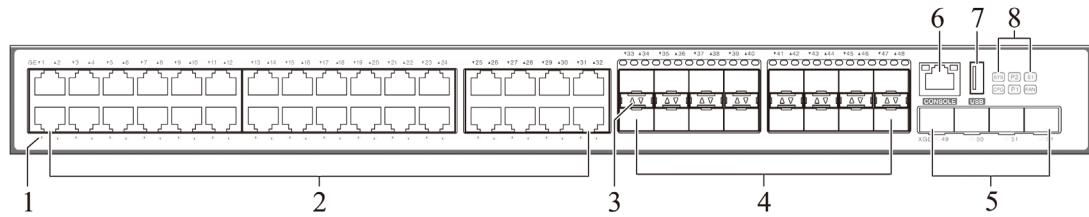

Figure 12: Front view

- |   |   |
|---|---|
| 1 | Gigabit electrical Interface status LED |
| 2 | Gigabit electrical Interface            |
| 3 | Gigabit optical Interface status LED    |
| 4 | Gigabit optical Interface               |
| 5 | 10 Gigabit optical Interface            |
| 6 | Console port                            |
| 7 | USB Interface                           |
| 8 | Device status LED                       |

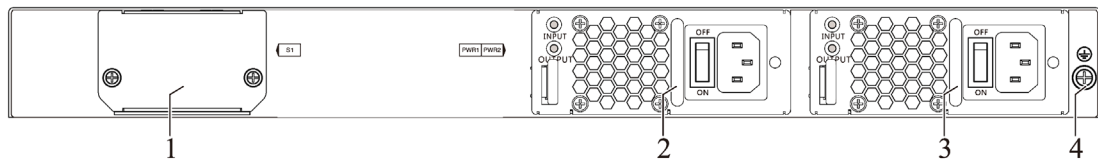

Figure 13: Rear view

- |   |                        |
|---|------------------------|
| 1 | Interface card Slot    |
| 2 | Modular power supply 1 |
| 3 | Modular power supply 2 |
| 4 | Grounding screw        |

### 1.3.13 Power module

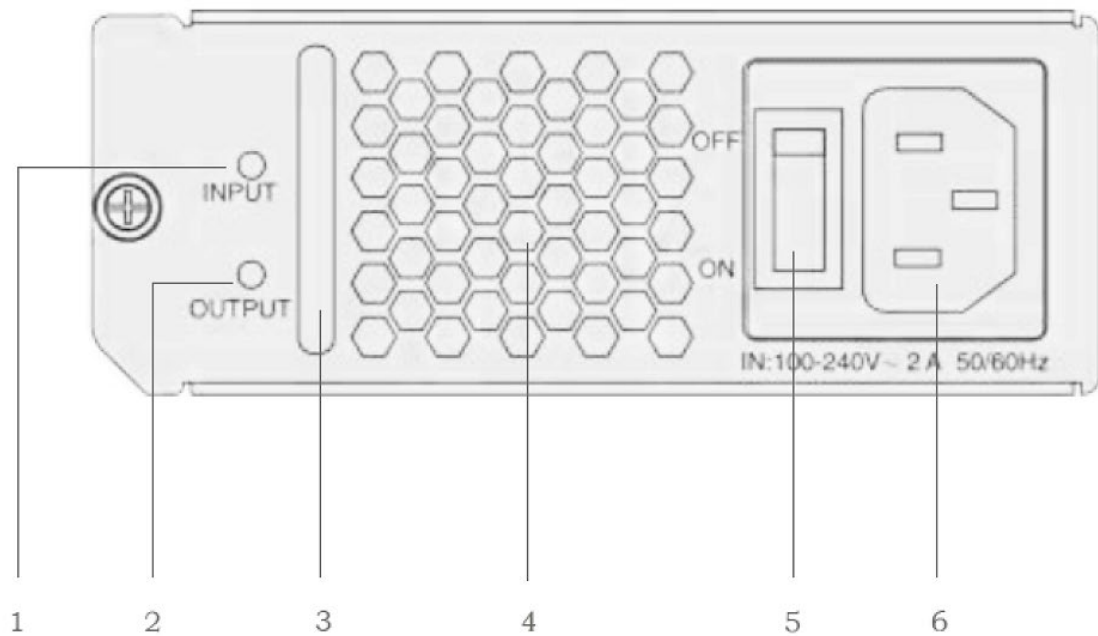

Figure 24: Front view

- |   |                          |
|---|--------------------------|
| 1 | Input status LED         |
| 2 | Output status LED        |
| 3 | Handle                   |
| 4 | Air outlet of the device |
| 5 | Power switch             |
| 6 | AC power socket          |

### 1.3.14 Media module

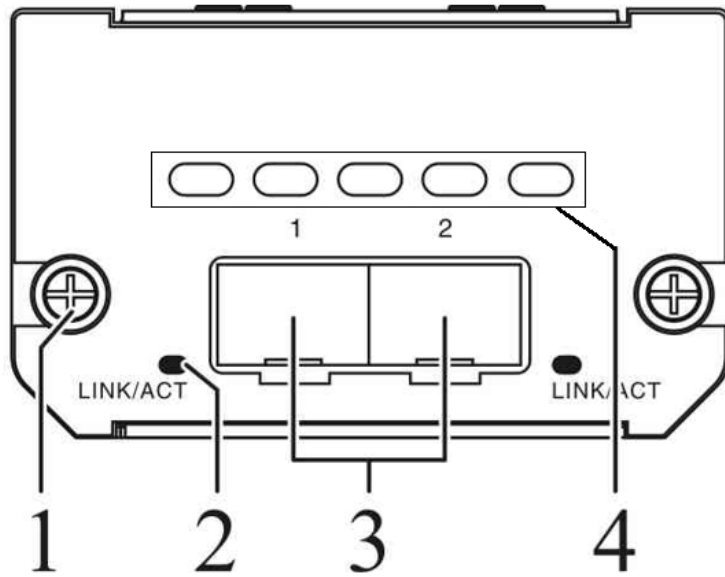

Figure 25: Front view

---

1 Anti-loosening screw

---

2 Device status LED

---

3 Gigabit ethernet port

---

4 Air-outlet of the device

---

## **1.4 Power supply**

You may use the power module to supply voltage to the device.

For information about connecting supply voltage:

See [“Power module” on page 23](#)

## 1.5 Ethernet ports

You can use fiber optic (F/O) to connect end devices and other network segments to the device and the media module ports.

### 1.5.1 1000 Mbit/s F/O port

This port is an SFP slot.

The port allows you to connect network components according to IEEE 802.3.

This port supports:

- ▶ Full duplex
- ▶ Delivery status
- ▶ 1 Gbit /s full duplex when Gbit Ethernet SFP transceiver is used.

### 1.5.2 10 Gbit/s F/O port

This port is a QSFP+ slot.

The port allows you to connect network components according to IEEE 802.3.

This port supports:

- ▶ Full duplex
- ▶ Delivery status
- ▶ 10 Gbit / s full duplex when 10 Gbit / s Ethernet QSFP+ transceiver is used.
- ▶ 1 Gbit / s full duplex when Gbit Ethernet SFP transceiver is used.

### 1.5.3 10/100/1000 Mbit/s twisted pair port

This port is an RJ45 socket.

The 10/100/1000 Mbit/s twisted pair port allows you to connect network components according to the IEEE 802.3 10BASE-T/100BASE-TX/1000BASE-T standard.

This port supports:

- ▶ Auto negotiation
- ▶ Auto polarity
- ▶ Auto crossing (if auto negotiation is activated)
- ▶ 1000 Mbit/s full duplex
- ▶ 100 Mbit/s half-duplex mode, 100 Mbit/s full duplex mode
- ▶ 10 Mbit/s half-duplex mode, 10 Mbit/s full duplex mode
- ▶ Delivery state: Auto negotiation activated

### 1.5.4 PoE(+) support

The 10/100/1000 Mbit/s twisted pair port allows you to connect network components according to standards IEEE 802.3

10BASE-T/100BASE-TX/1000BASE-T and IEEE 802.3af/at.

PoE power is supplied by cable pair (virtual voltage) of transmission signals.

Maximum available PoE power consumption of MTS2724-4X-FP-S is 380 W.

Maximum available PoE power consumption of

MTS2724-6X-MP-E/MTS2748-6X-MP-E is 720 W, related to power supplies selected.

### 1.5.5 Out-of-band management port

This port is an RJ45 socket.

The port allows you to connect network components according to IEEE 802.3 10BASE-T/100BASE-TX.

This port supports:

- ▶ Auto negotiation
- ▶ 100 Mbit/s half-duplex, 100 Mbit/s full duplex, 10 Mbit/s half-duplex, 10 Mbit/s full duplex

The port allows you to manage the device and upload configuration through the following protocols:

- ▶ SNMP
- ▶ SSH
- ▶ Telnet
- ▶ FTP

See “Command line interface user manual” for more information. The manual is available for download on the Internet: <https://catalog.belden.com>



## 1.6 Display elements

After the supply voltage is set up, the software starts and initializes the device. Afterwards, the device performs a self-test. During this process, various LEDs light up.

### 1.6.1 Device status

These LEDs provide information about the conditions which affect the operation of the whole device.

Indicator type	Indicator name	Indicator color	Status
System status LED	SYS	Green	<b>Quick flashing (flashing 5 times per second):</b> indicating hardware starts to work after power on <b>Slow flashing (flashing 1 time per 2 seconds):</b> indicating the system is working normally <b>OFF:</b> indicating an exception to the system running.
Power light	PWR	Green	<b>ON:</b> indicating all in-place power modules are working normally. <b>OFF:</b> indicating an exception to the in-place power modules.
Fan indicator	FAN	Green	<b>ON:</b> indicating all fan modules on the equipment are working normally. <b>OFF:</b> indicating an exception to at least one fan module on the equipment.
STACK indicator	STACK	Green	<b>Flashing:</b> indicating stacking function is enabled, and the equipment is the main unit of the stacking system. <b>ON:</b> indicating stacking function is enabled, and the equipment is not the main unit of the stacking system. <b>OFF:</b> indicating stacking function is not enabled.
ID indicator	ID	Blue	<b>Quick flashing (flashing 5 times per second):</b> used for site positioning, and for the operation and maintenance personnel to remotely control the ID light on and off. <b>OFF:</b> indicating ID light is not enabled, by default.

## 1.6.2 Port status

These LEDs provide port information.

Indicator type	Indicator name	Indicator color	Status
Serial port indicator	TXD	RJ45 self-contained yellow LED	<b>Flashing</b> : indicating data sending on serial port <b>OFF</b> : indicating no data sending on serial port.
	RXD	RJ45 Build-in green LED	<b>Flashing</b> : indicating data receiving on serial port <b>OFF</b> : indicating no data receiving on serial port..
DC0 interface indicator	1000 Mbit/s	RJ45 self-contained yellow LED	<b>OFF</b> : indicating DC0 works at 10/100 Mbit/s or is unlinked. <b>ON</b> : indicating DC0 works at 1000 Mbit/s.
	ACT	RJ45 Build-in green LED	<b>OFF</b> : indicating DC0 interface is unlinked <b>ON</b> : indicating DC0 interface is linked with no data sending and receiving. <b>Flashing</b> : indicating DC0 interface is linked with data sending and receiving.
Port status LED	LINK/ACT	Green	<b>ON</b> : indicating successful connection establishment on Ethernet port <b>Flashing</b> : indicating data sending and receiving on Ethernet port. <b>OFF</b> : indicating no connection establishment on Ethernet port.

## **1.7 Management interfaces**

### **1.7.1 DC0 interface (external management)**

The serial interface is provided on RJ45 socket (DC0 interface), which can realize the local connection of external management station (VT100 terminal or PC with corresponding terminal emulation). This enables you to set up a connection to the Command Line Interface CLI and to the System Monitor.

### **1.7.2 USB interface**

The switch provides 2 serial ports (EIA/TIA-232 and Micro USB 2.0). These serial ports allows the users to configure the switch using the PC (or laptop) equipped with RS-232 serial port (or USB interface).

# 1 Installation

These devices are developed for use in commercial environments. At the time of delivery, the equipment is ready for operation.

Perform the following work steps to install and configure the device:

- Checking the package contents
- Installing the power module (optional)
- Installing and grounding the device
- Operating the device
- Installing the SFP transceiver (optional)
- Connecting the data cables
- Filling out the inscription Label

## 2.1 Checking the package contents

- Check whether the box contains all the items specified in the section, See [“Delivery items” on page 84](#)
- Check the individual parts for transport damage.

## 2.2 Installing the power module (optional)

**Note:** Hirschmann IT provides ready-to-run power modules. You can choose to install the power module while the device is running.

Perform the following work steps:

- Remove the cover plate from the power module slot of the device.
- Put the power module into the power module slot of the device.  
See [Figure 26](#)

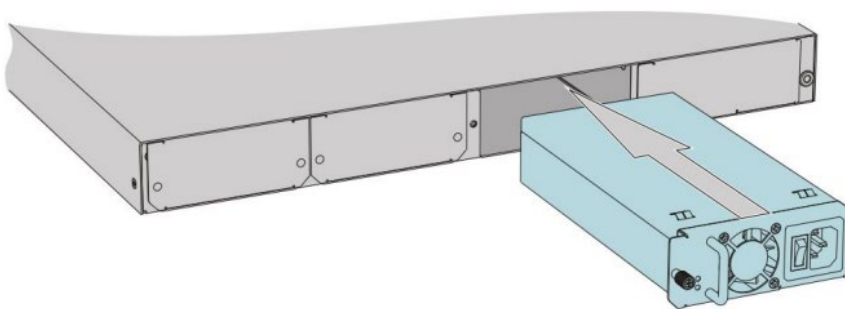

*Figure 146: Installing the power module*

## 2.3 Installing and grounding the device

Perform the following work steps:

- Installing the device in the switch cabinet
- Installing the device on a vertical flat surface
- Grounding the device

### 2.3.1 Installing the device in a switch cabinet

#### **WARNING**

##### **ELECTRIC SHOCK**

Install this device solely in a switch cabinet or in an operating site with restricted access, to which maintenance staff have exclusive access.

**Failure to follow this instruction can result in death, serious injury, or device damage.**

#### **CAUTION**

##### **OVERHEAT**

When installing equipment, make sure that the ventilating slots are not covered.

**Failure to comply with these guidelines may result in minor injury or equipment damage.**

#### **CAUTION**

##### **BURNING HAZARD**

The surfaces of the device housing may become hot. Avoid touching the device while it is operating.

**Failure to follow this instruction can result in injury.**

**Note:** When the device is operated in an environment with continuous vibration load greater than 0.7 g, it must be fixed to the switch cabinet with the 2 fixed mounting brackets at the front and rear of the device. Additional mounting brackets are provided as accessories. See [“Accessories” on the page 84](#)

Prerequisites:

- Install the device in a 19" switch cabinet by means of the slide or mounting rails. It improves the stability of the device in an environment affected by vibrations. For more information about the slide or mounting rails and how to install them, please contact the switch cabinet manufacturer.
- The device is designed to be installed in a 19" switch cabinet. At the time of delivery, 2 preinstalled fixed mounting brackets come with the device on the side.
  
- Make sure the device is well ventilated. If necessary, install a fan to help prevent overheating.
- Measure the depth of the 19" cabinet for easy connection.

Perform the following work steps:

- Install the sliding or mounting rails in a 19" switch cabinet as specified by the manufacturer.
- Wear an ESD wrist strap and check the grounding and stability of the cabinet
- Install the floating nuts in the marked positions. See [Figure 27](#).

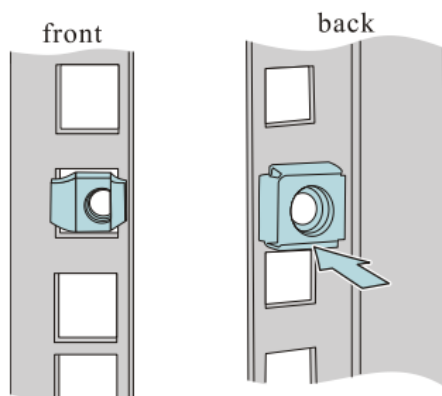

*Figure 27: Installing the floating nuts*

- Place the device on the rail in the switch cabinet.
- Attach the mounting bracket to the switch cabinet using screws that meet the cabinet installation requirements (the screws are provided by the cabinet manufacturer and are rust proof on their surfaces). Ensure that the screws are in horizontal position. See [Figure 28](#).

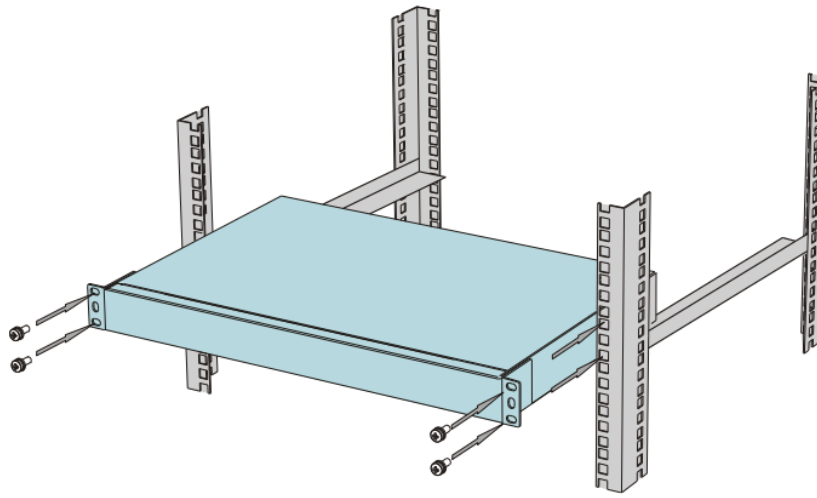

*Figure 28: Installing the device in a switch cabinet*

### 2.3.2 Installing the device on a vertical flat surface

## **WARNING**

### **FIRE RISK**

In case of vertical installation, install the device in a fireproof enclosure.

**Failure to follow this instruction can result in death, serious injury, or device damage.**

Perform the following work steps:

- Attach 2 mounting brackets to the rear of the device.
- Install the 2 screws to attach the mounting brackets to the wall.  
See [Figure 29](#).
- Tighten the 2 screws with the tightening specified in the chapter, see ["General technical data" on page 59](#)

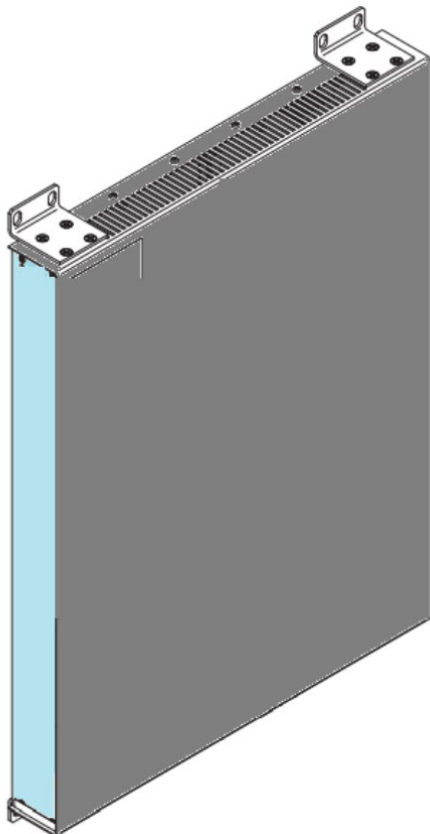

*Figure 15: Installing the device on a vertical flat surface*



### 2.3.3 Grounding the device

## **WARNING**

### **ELECTRIC SHOCK**

Ground the device before connecting any other cables.

**Failure to follow this instruction can result in death, serious injury, or device damage.**

The device has the connection of the protective grounding wire.

The device is grounded by the grounding screw and the power socket.

Perform the following work steps:

- Install the grounding screw at the rear of the device to the protective conductor, see [Figure 30](#).

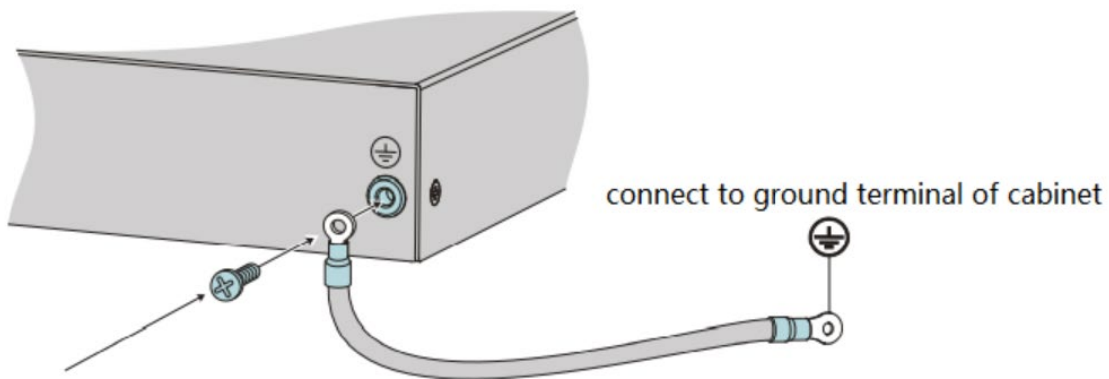

*Figure 30: Grounding the device*

- Tighten the grounding screw with the tightening torque specified in chapter, see [“General technical data” on page 59](#).

## 2.4 Installing the SFP transceiver (optional)

Prerequisite:

Exclusively use Hirschmann IT SFP transceivers.

See [“Accessories” on the page 84](#).

Perform the following work steps:

- Take the SFP transceiver out of the transport packaging.
- Remove the protection cap from the SFP transceiver. See [Figure 31](#).

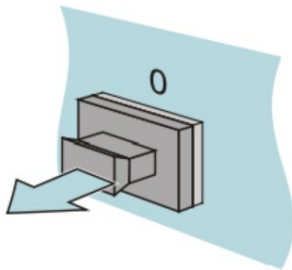

*Figure 31: Removing the Protection Cap*

- Push the SFP transceiver with the lock closed into the slot until it latches in. See [Figure 32](#).

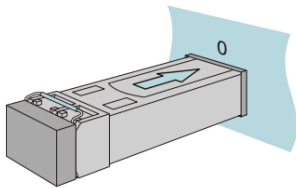
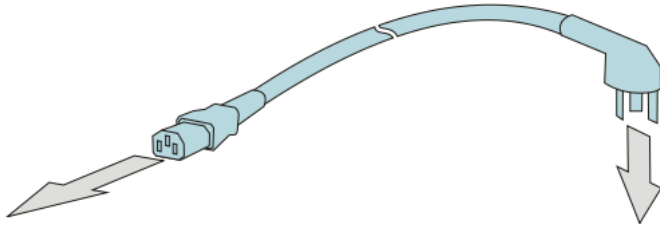

*Figure 16: Installing the transceiver*

## 2.5 Operating the device

Perform the following work step:

- Connect the power supply cable, see [Figure 33](#).
- Enable the power supply.



*Figure 17: Connect the power supply*

## 2.6 Connecting data cables

Note the following general recommendations for data cable connections in an environment with high electrical interference levels:

- Keep the length of the data cables as short as possible.
- Use optical data cables for the data transmission between the buildings.
- When using copper cables, provide a sufficient separation between the power supply cables and the data cables. Ideally, install the cables in separate cable channels.
- Verify that power supply cables and data cables do not run parallel over longer distances. To reduce inductive coupling, verify that the power supply cables and data cables cross at a 90° angle. Use SF/UTP cables according to ISO/IEC 11801:2002.
- Only shielded twisted pair cables are allowed in DNV GL EMC Class B area.
- Connect the data cable according to your requirements.  
See [“Ethernet ports” on page 39](#)
- You find the prescribed tightening torque of the locking screw in chapter:  
See [“General technical data” on page 59](#)

## **2.7 Filling out the inscription label**

The information field for the MAC address helps you identify your device.

## 2 Making basic settings

**Note:** Configuring 2 or more devices with the same IP address may lead to the network's failure to function as expected.

Install and maintain a program, to assign a unique IP address to each device in the network.

Enter the IP parameters when you install the device for the first time.

### **3 Monitoring the ambient air temperature**

Operate the device below the specified maximum ambient air temperature exclusively.

See ["General technical data" on page 59](#)

The ambient air temperature is the temperature of the air at a distance of 5 cm (2 in) from the device. It depends on the installation conditions of the device, for example, the distance from other devices or other objects, and the output of neighboring devices.

The temperature displayed in the CLI and the GUI is the internal temperature of the device. It is higher than the ambient air temperature. The maximum internal temperature of the device named in the technical data is a guideline that indicates to you that the maximum ambient air temperature has possibly been exceeded.

If the ambient temperature exceeds the normal operating range of the device, additional protective measures are recommended.

## 4 Maintenance and service

- When designing this device, Hirschmann IT largely avoided using high-wear parts. The parts subject to wear and tear are dimensioned to last longer than the lifetime of the product when it is operated normally. Operate this device according to the specifications.
- Relays are subject to natural wear. This wear depends on the frequency of the switching operations. Check the resistance of the closed relay contacts and the switching function depending on the frequency of the switching operations.
- The internal fuse triggers only when the equipment detects an error. In case of any damage or failure to the equipment, switch off the power and return the equipment to the plant for inspection.
- Hirschmann IT is continually working on improving and developing their software. Check regularly whether there is an updated version of the software that provides you with additional benefits. You find information and software downloads on the Hirschmann IT product pages on the Internet <https://catalog.belden.com>.
- Depending on the degree of pollution in the operating environment, check at regular intervals that the ventilation slots in the device are not obstructed.

**Note:** You find information on settling complaints on the Internet at: <http://www.beldensolutions.com/en/Service/Repairs/index.phtml>

## 5 Disassembly

### 6.1 Removing the power module (optional)

Perform the following work steps:

- Pull the power module out of the power module slot.
- Blank the power module slot on the device using the cover plate.

### 6.2 Removing the media module

Perform the following work steps:

- Remove the screws from the front panel of the media module.
- Pull the locking lever outward to unlock the media module.
- Pull the media module out of the slot. See [Figure 34](#).

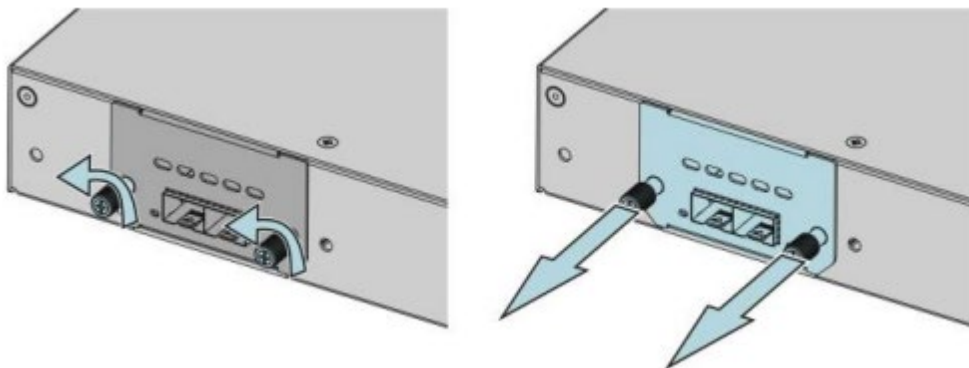

*Figure 34: Removing the media module*

- Put a cover plate at the media module slot on the device.
- Install 2 screws to attach the cover plate to the media module slot.
- Tighten the 2 screws with the tightening specified in chapter, see ["General technical data" on page 59](#)



## 6.3 Removing the SFP transceiver (optional)

Perform the following work steps:

- Release the lock and pull the SFP transceiver out of the device slot.  
See [Figure 35](#).

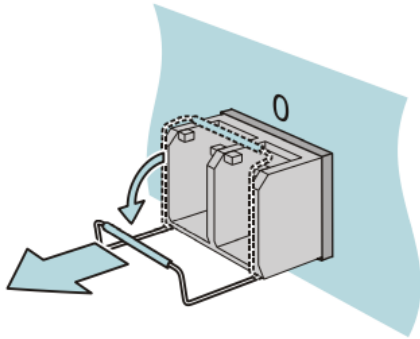

*Figure 18: Releasing the lock*

- Use a protective cover to blank the SFP transceiver.  
See [Figure 36](#).

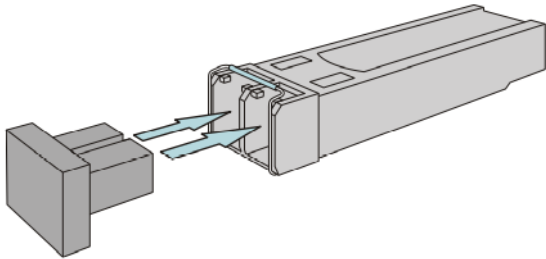

*Figure 36: Installing the Protective Cover*

## 6.4 Removing the device

### **WARNING**

#### **ELECTRIC SHOCK**

Please disconnect all other cables before disconnecting the ground wire.

**Failure to follow these instructions can result in death, serious injury, or device damage.**

Perform the following work steps:

- Disconnect the data cables.
- Disable the supply voltage.
- Disconnect the power supply cable.
- Disconnect the grounding.

#### 6.4.1 **Removing the device from a vertical flat surface**

Perform the following work steps:

- Remove the 2 screws that attach the mounting bracket to the vertical flat surface.
- Remove the 2 mounting brackets from the rear of the device.

#### 6.4.2 **Removing the device from the switch cabinet**

Perform the following work steps:

- Remove the screws that attach the mounting bracket to the switch cabinet.
- Take out the device from the rails on the switch cabinet.
- Uninstall the mounting rails from the 19" switch cabinet as specified by the manufacturer.

## 6 Technical data

### 7.1 General technical data

#### ■ Basic device

Dimensions W × H × D	See “ <a href="#">Dimension drawings</a> ” on page 61		
Weight	MTS2624-4X-B	2.8 kg (6.17 lb)	
	MTS2648-6X-B	6 kg (13.22 lb)	
	MTS2724-4X-FP-S	5.5 kg (12.12 lb)	
	MTS2724-6X-MP-E	6 kg (13.22 lb)	
	MTS2748-6X-MP-E	6 kg (13.22 lb)	
	MTS2832TF-4X-E	4 kg (8.81 lb)	
	MTS2824F-4X-S	5 kg (11.02 lb)	
	MTS2824-4X-S	3 kg (6.61 lb)	
	MTS2848-6X-S	5 kg (11.02 lb)	
	MTS2824-6X-E	6 kg (13.22 lb)	
	MTS2848-6X-E	5 kg (11.02 lb)	
	MTS2848TF-4X-E	5 kg (11.02 lb)	
Power supply	Rated voltage range	100 V AC...240 V AC	50 Hz ... 60 Hz
		Maximum conductor diameter	AWG12 (2.5 mm)
Device grounding	Tightening torque	0.4 Nm ... 0.7 Nm (3.5 lb-in ...	
	Protective grounding	6.1 lb-in)	
Climatic conditions during operation	Ambient air temperature	-5 °C ... +55 °C (2000 m) <b>Note:</b> The altitude is 2000 m ... 4000 m (6561.6 ft ... 13123.3 ft), and the maximum working temperature decreases by 1°C (33.8 °F) every 200 m (656.1 ft) above sea level.	
	Humidity	10%~90%/RH, non-condensing	
Climatic conditions during storage	Altitude	<5000 m (16404.2 ft)	
Pollution level		2	
Protection Level	Laser protection	Class 1 according to IEC 60825-1	
	Degree of protection	IP20	

## ■ Power module

Size	See <a href="#">“Dimension drawings” on page 73</a>	
Weight	MTM2700-PSU120	0.9 kg (1.98 lb)
	MTM2700-PSU500	1.2 kg (2.64 lb)
	MTM2700-PSU880	1.4 kg (3.09 lb)
	MTM2800-PSU120	0.9 kg (1.98 lb)
Installation of the power module	Tightening torque	0.4 Nm ... 0.6 Nm (3.5 lb-in ... 5.2 lb-in)
Installation of the cover plate	Tightening torque	0.4 Nm ... 0.6 Nm (3.5 lb-in ... 5.2 lb-in)
Power module	Rated voltage range	100 V AC ... 240 V AC, 50 Hz ... 60 Hz

## ■ Media module

Size	See <a href="#">“Dimension drawings” on page 77</a>	
Weight	MTM2700-2X	0.16 kg (0.35 lb)
	MTM2800-2X	0.16 kg (0.35 lb)
Install media module	Tightening torque	0.2 Nm ... 0.3 Nm (2.0 lb-in ... 3.1 lb-in)
Mount cover plate	Tightening torque	0.2 Nm ... 0.3 Nm (2.0 lb-in ... 3.1 lb-in)

## 7.2 Dimension drawings

### ■ Basic device

#### MTS2624-4X-B

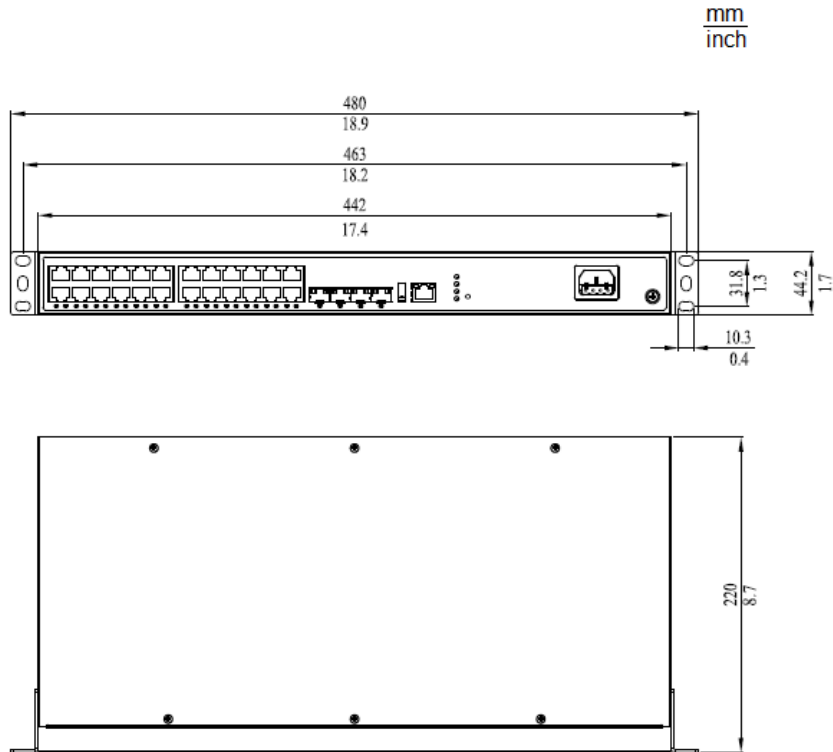

# MTS2648-6X-B

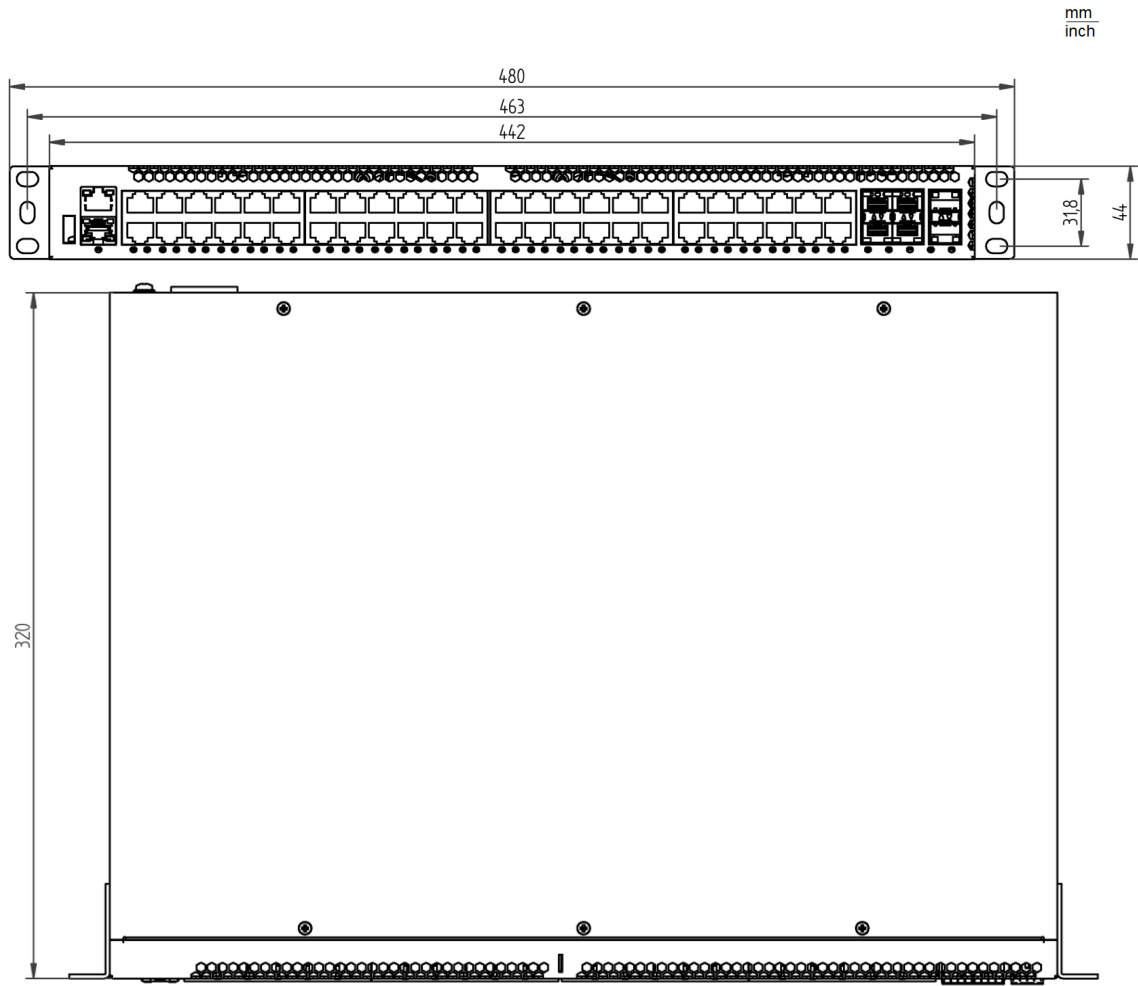

# MTS2724-4X-FP-S

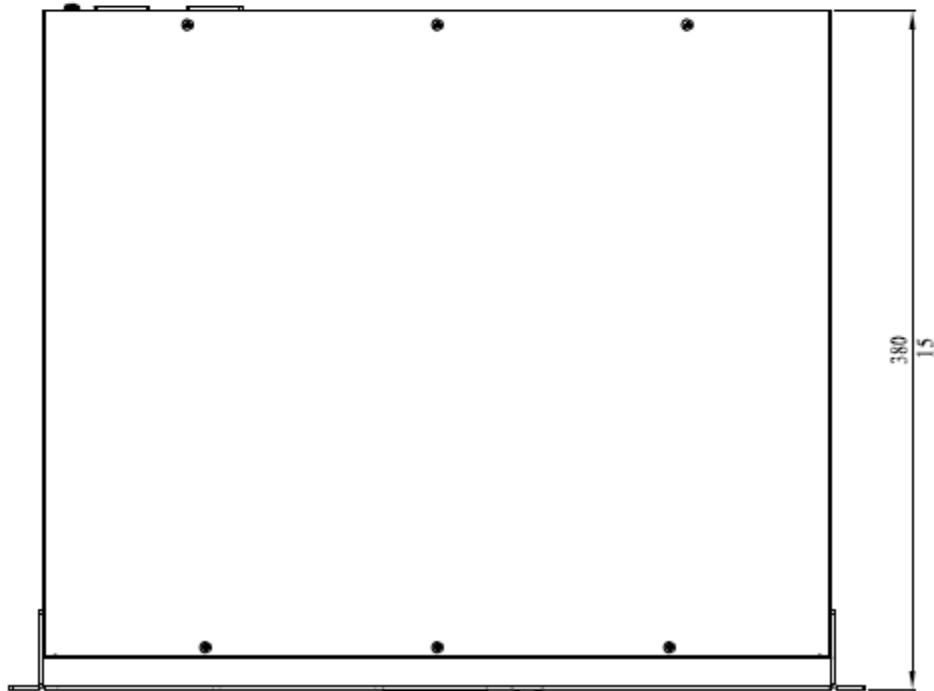
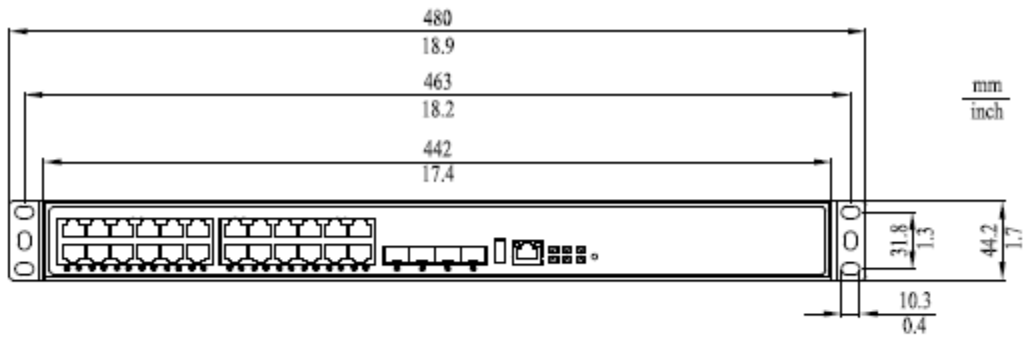

# MTS2724-6X-MP-E

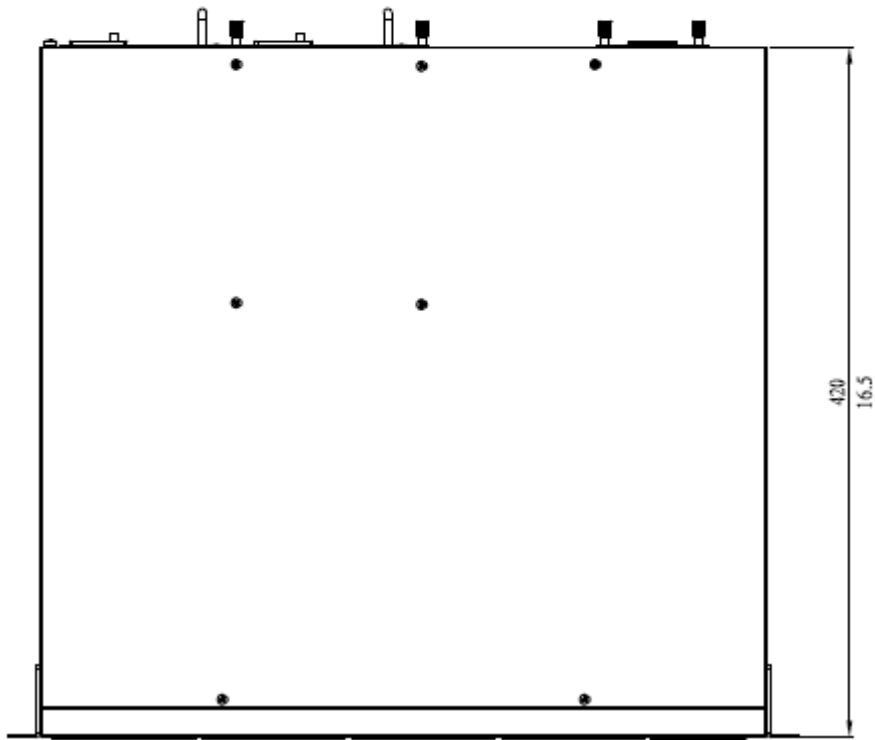
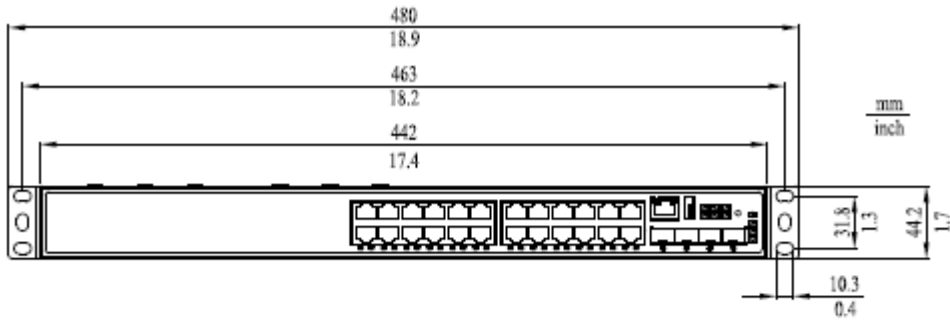



# MTS2748-6X-MP-E

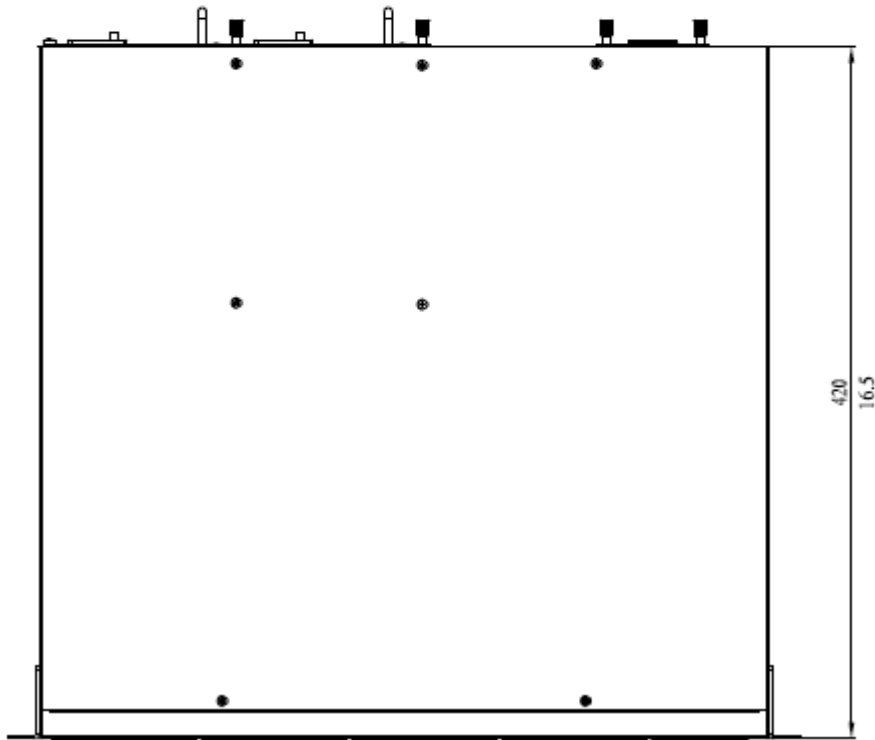
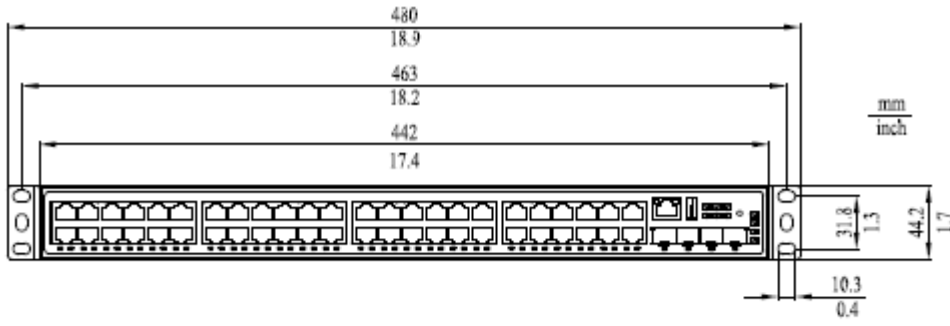

# MTS2832TF-4X-E

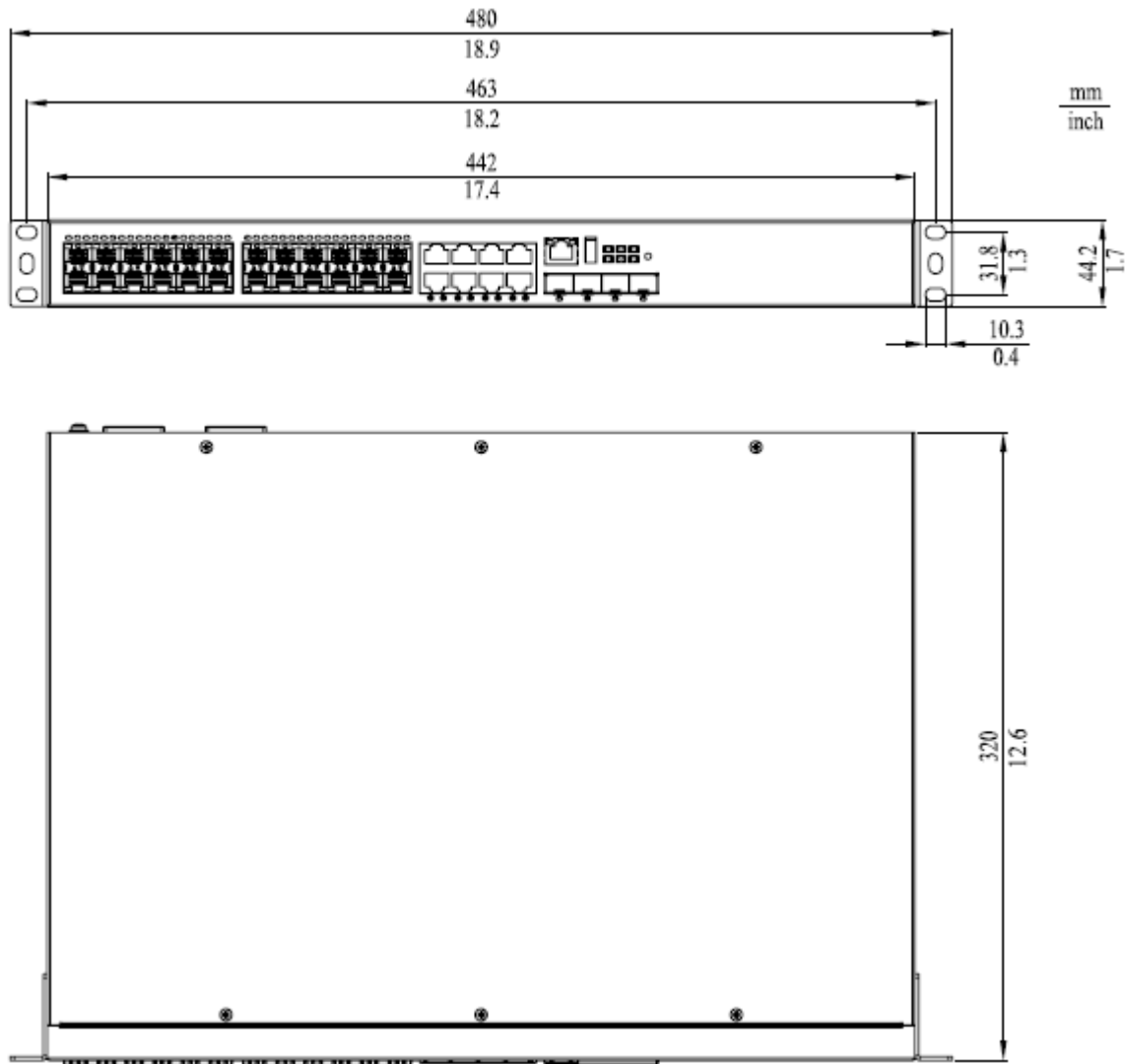

# MTS2824F-4X-S

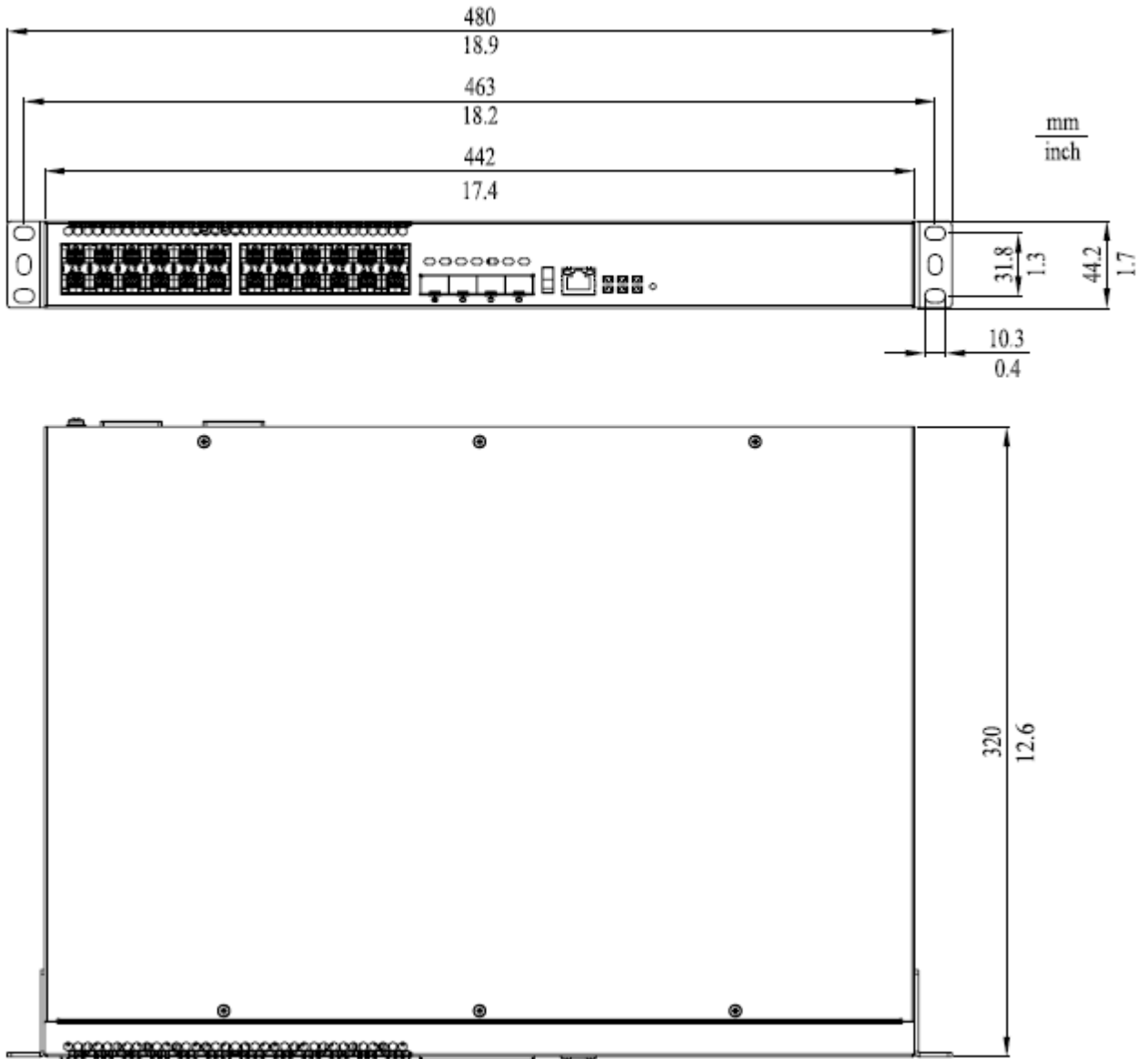

# MTS2824-4X-S

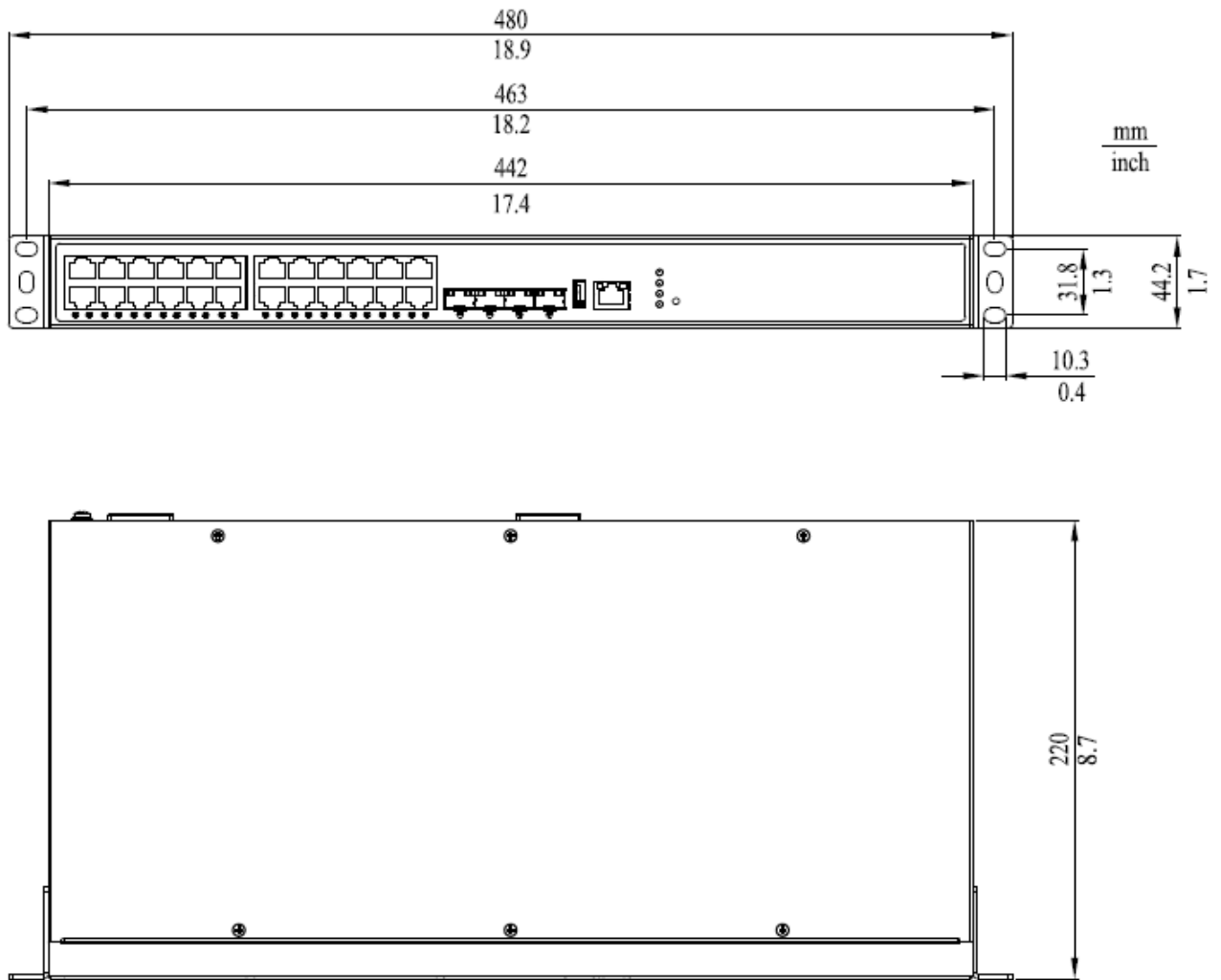

# MTS2848-6X-S

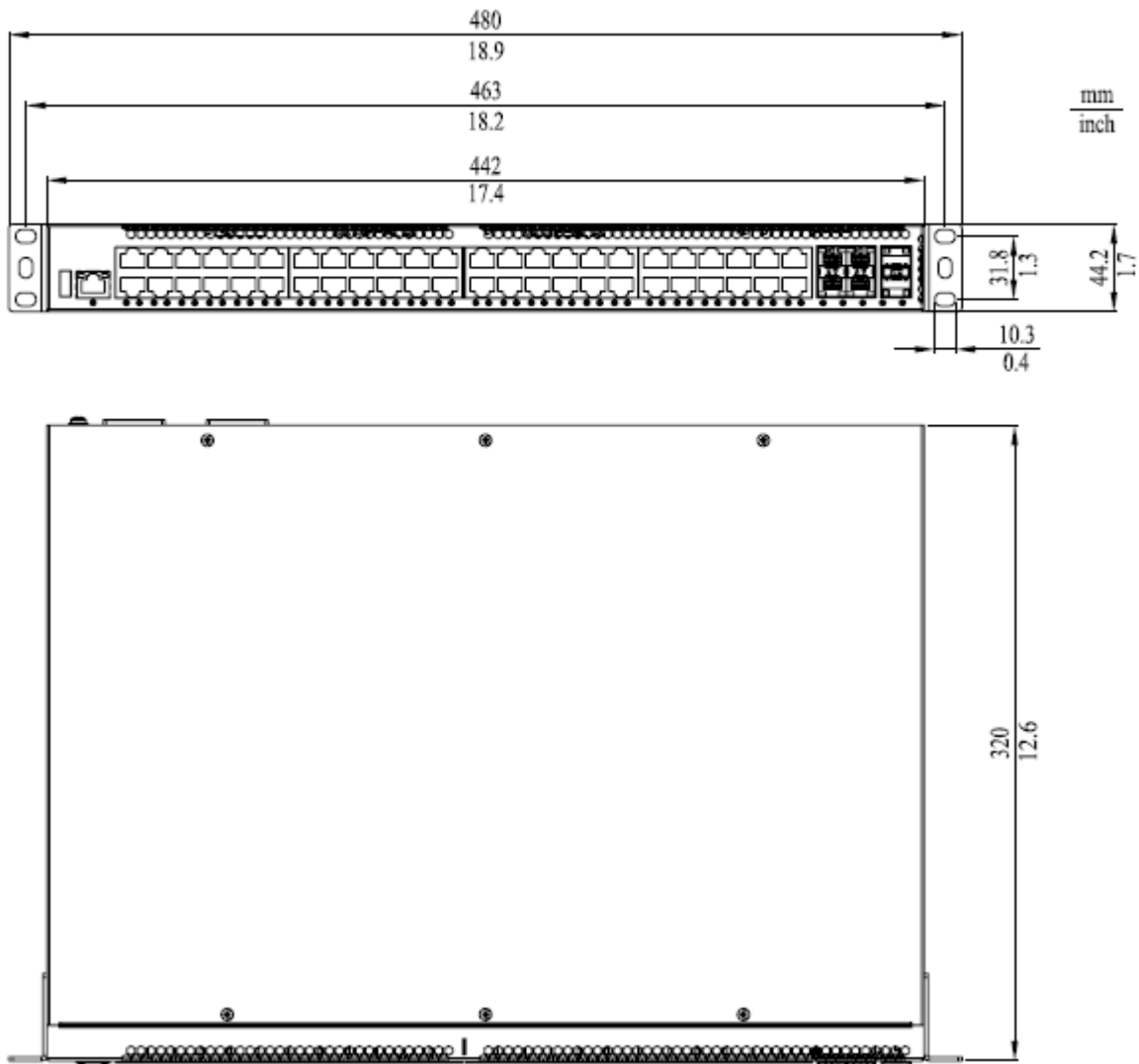

# MTS2824-6X-E

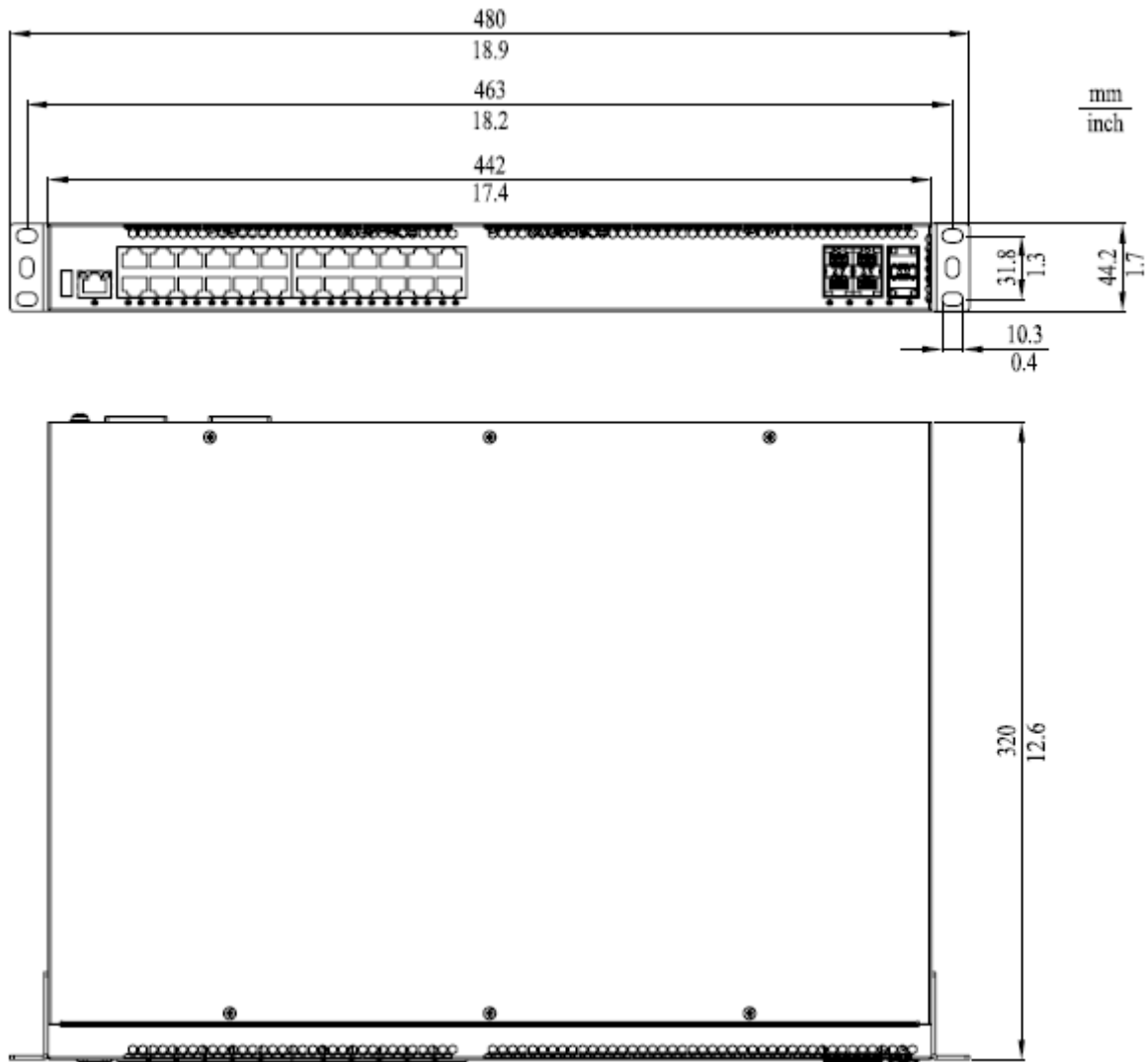

# MTS2848-6X-E

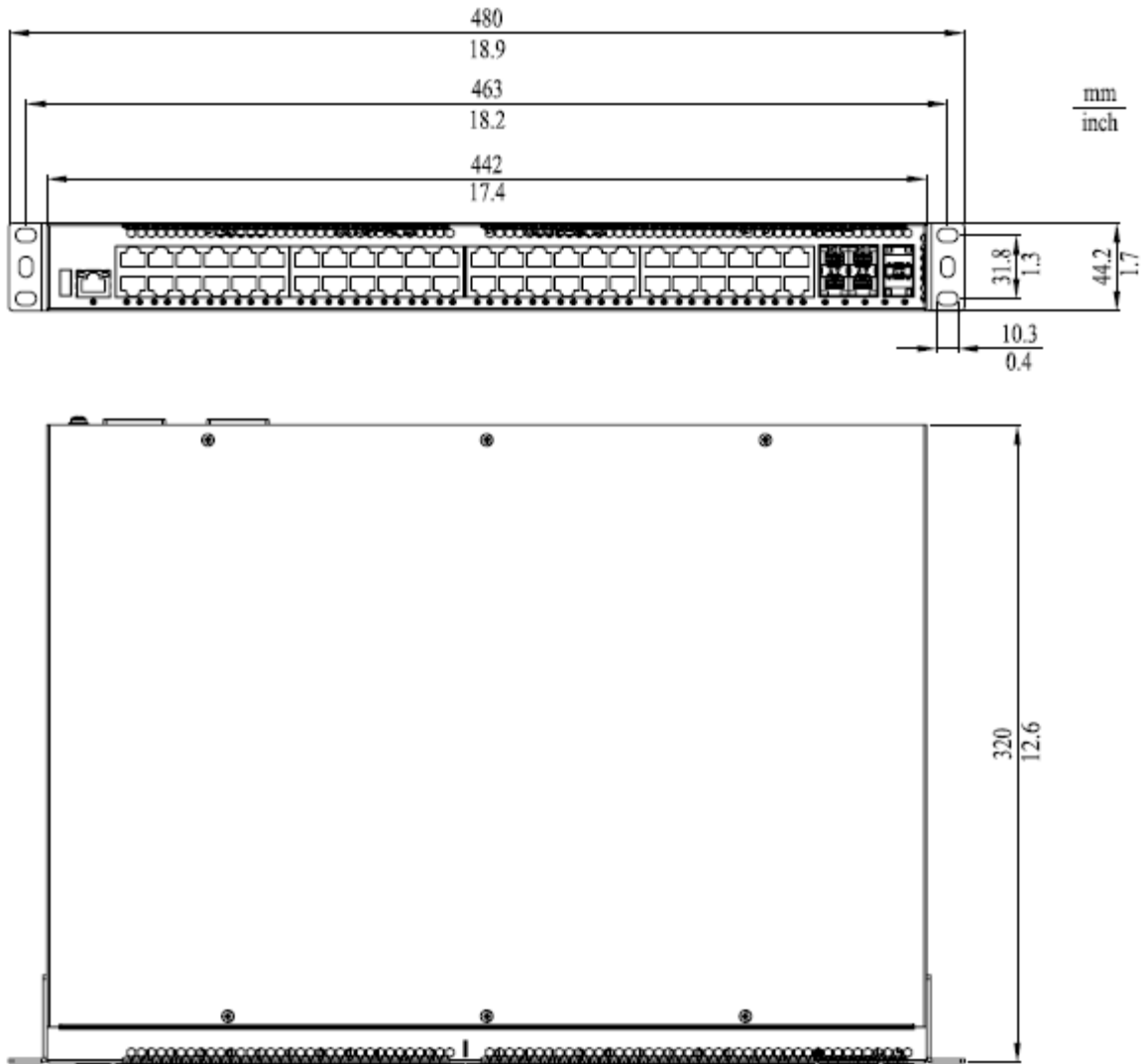

# MTS2848TF-4X-E

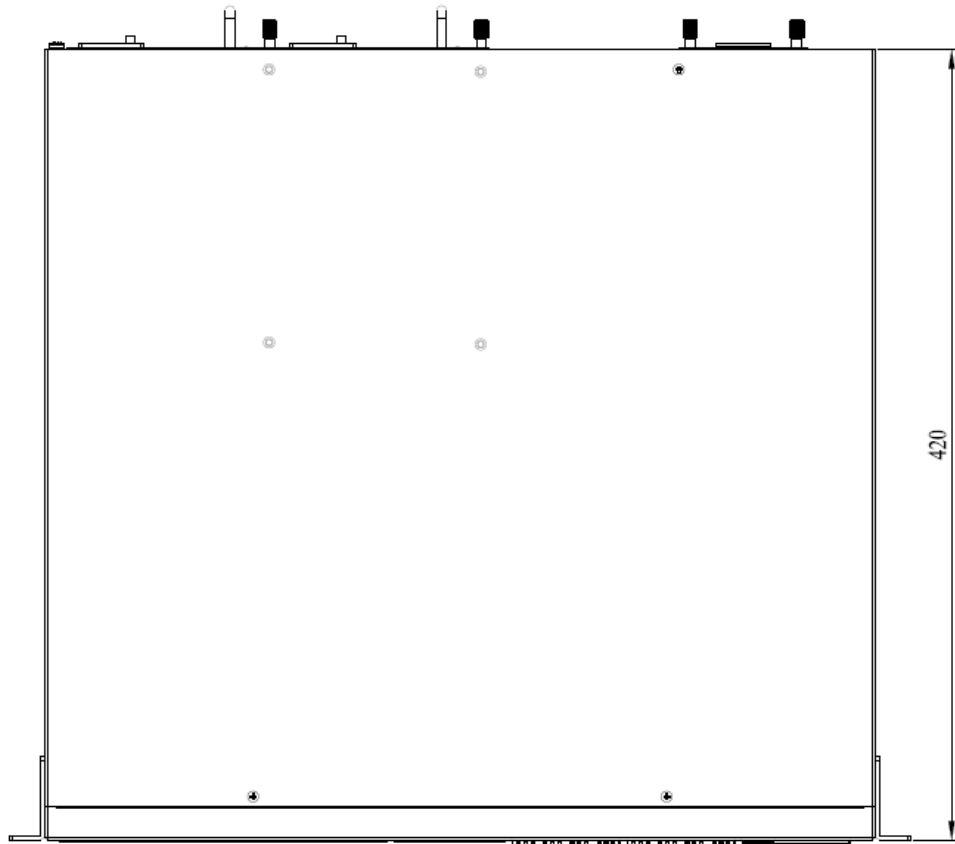
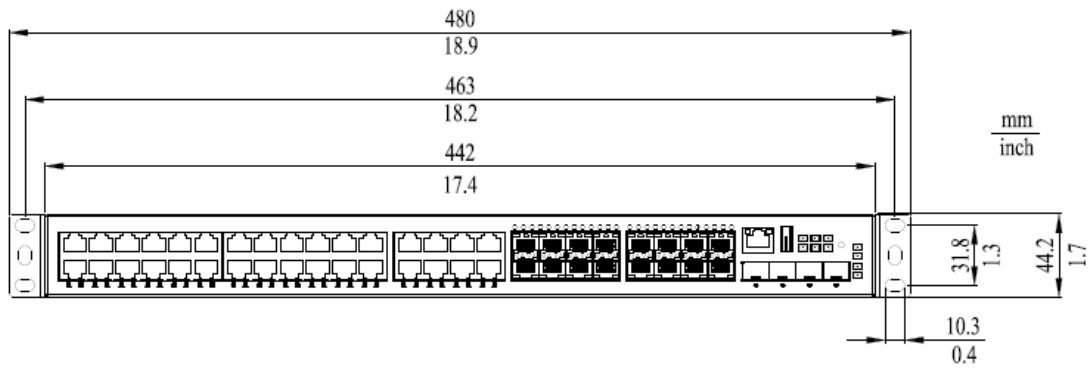



## ■ Power module

### MTM2700-PSU120

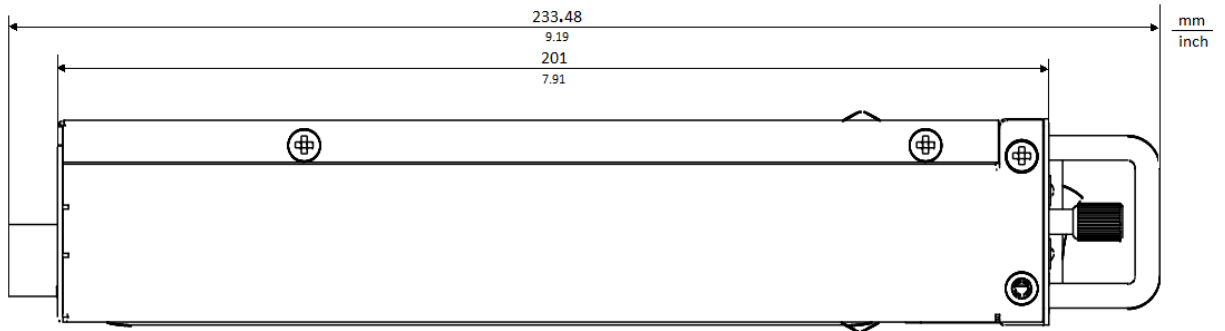
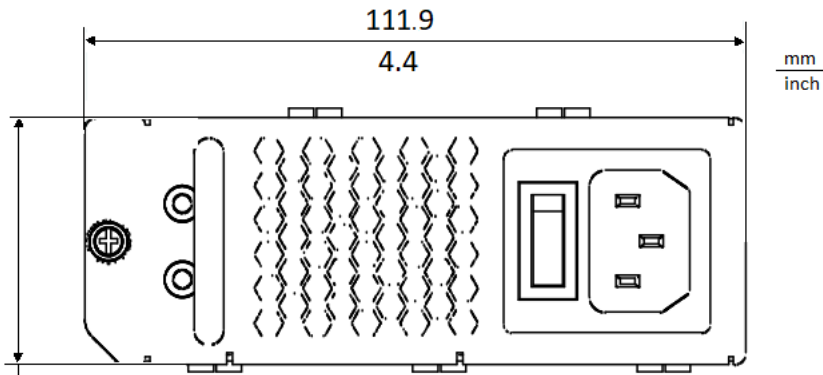

# MTM2700-PSU500

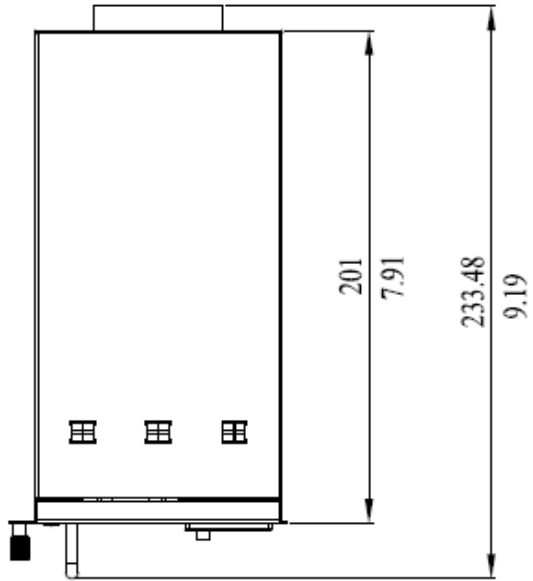
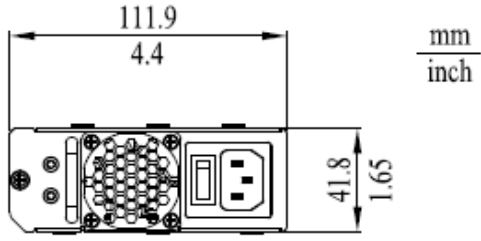

# MTM2700-PSU880

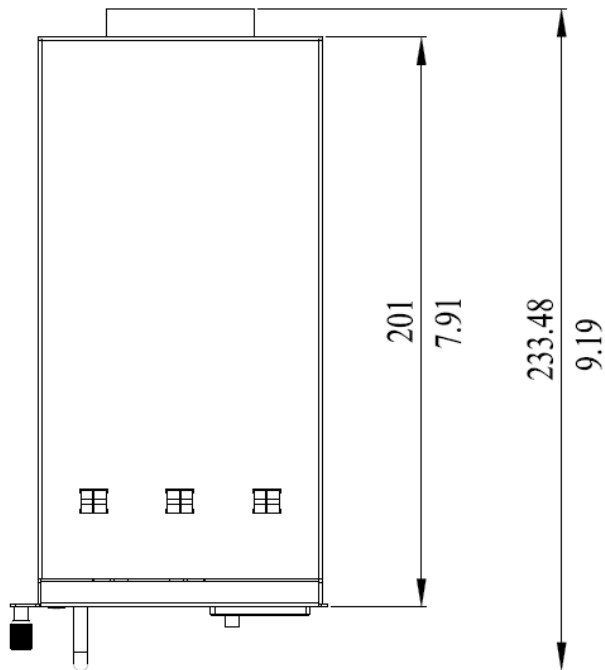
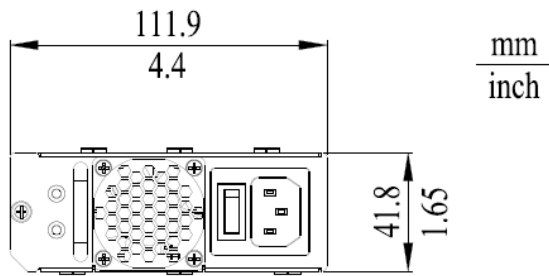

# MTM2800-PSU120

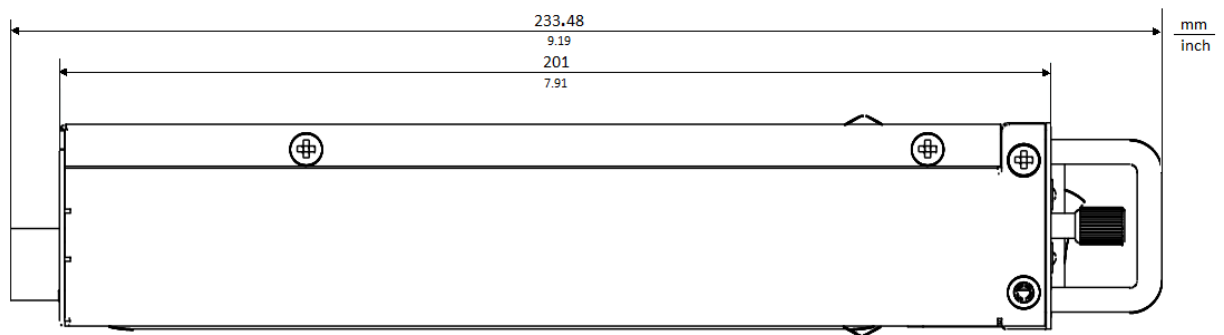
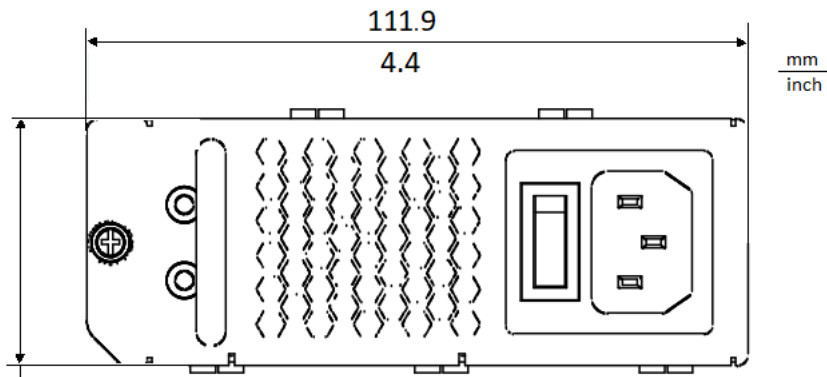

## ■ Media module

### MTM2700-2X

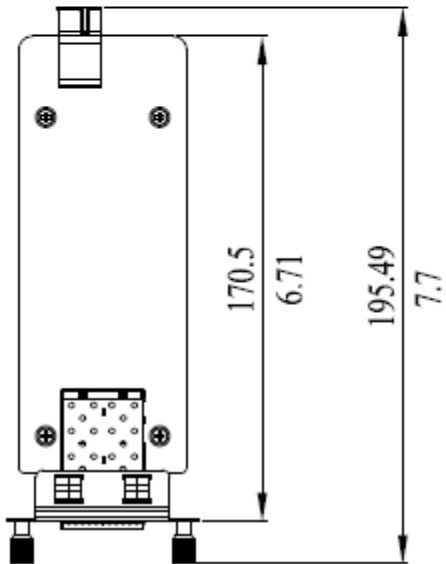
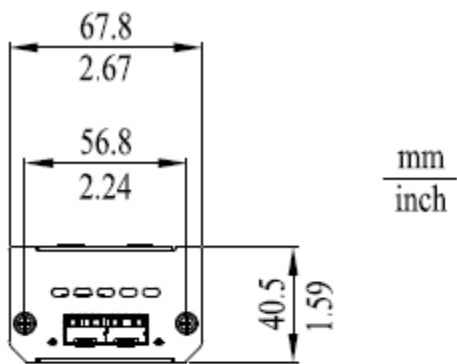

# MTM2800-2X

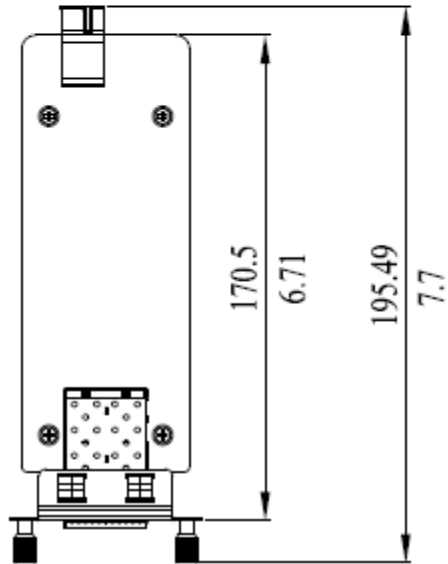
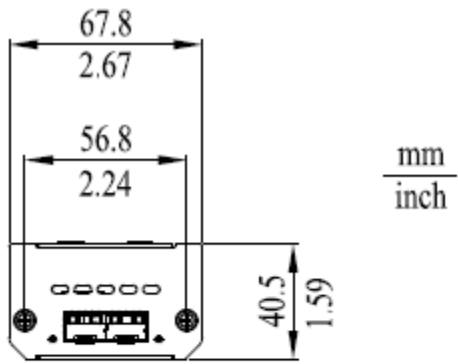

## 7.3 Electromagnetic compatibility (EMC)

EMC interference emission		Standard application
EN 55032		Class A
DNV GL Guide		—
FCC 47 CFR Part 15		Class A
EN 61000-6-4		Fulfilled
EN 55032	AC/DC Power Line	Class A
DNV GL Guide	AC/DC Power Line	—
FCC 47 CFR Part 15	AC/DC Power Line	Class A
EN 61000-6-4	AC/DC Power Line	Fulfilled
EN 55032	Signal Line	Class A
EN 61000-6-4	Signal Line	Fulfilled
<b>Harmonic current</b>		
EN 61000-3-2		Class A
<b>Voltage flicker</b>		
EN 61000-3-3		

EMC interference immunity		Standard application
Electrostatic discharge		
EN 61000-4-2 IEEE C37.90.3	Contact discharge	±4 kV
EN 61000-4-2 IEEE C37.90.3	Air discharge	±8 kV

<b>EMC immunity</b>		<b>Standard application</b>
Electromagnetic field		
EN 61000-4-3	80 MHz ... 1000 MHz 1000 MHz ... 6000 MHz	10 V/m 3 V/m
IEEE 1613	80 MHz ... 1000 MHz	—
Fast transient (burst)		
EN 61000-4-4 IEEE C37.90.1	AC/DC Power Line	±2 kV
EN 61000-4-4 IEEE C37.90.1	Data cable	±1 kV
EN 61000-4-5	Cable / ground	±2 kV
Voltage surge - power cable		
IEEE 1613	Cable / ground	—
EN 61000-4-5	Cable / cable	±1 kV
Voltage surge - data cable		
EN 61000-4-5	Cable / ground	±1 kV
Conducted immunity		
EN 61000-4-6	150 kHz ... 80 MHz	10 V



EMC immunity		Standard application
Damped vibration - AC/DC Power Line		
EN 61000-4-12 IEEE C37.90.1	Cable / ground	—
EN 61000-4-12 IEEE C37.90.1	Cable / cable	—
Damped oscillation - data cable		
EN 61000-4-12 IEEE C37.90.1	Cable / ground	—
EN 61000-4-12	Cable / cable	—
Pulsed magnet field		
EN 61000-4-9		—
Power frequency magnetic field		
EN 61000-4-8		30 A/m
Voltage dips, short interruptions		
EN 61000-4-11	AC/DC Power Line	20 ms $\Delta U$ 100 % 200 ms $\Delta U$ 60 % 500 ms $\Delta U$ 30 % 5 s $\Delta U$ 100 %

## 7.4 Immunity

Immunity		Standard application
IEC 60068-2-6, Test Fc	Vibration	5 Hz ... 8.4 Hz, with 3.5 mm (0.14 in) amplitude 8.4 Hz ... 150 Hz with 1 g
IEC 60068-2-27, Test Ea	Shock	15 g / 11 ms

## 7.5 Network range

**Note:** The line length specified for the transceiver applies to the corresponding fiber data (fiber attenuation and BLP/dispersion).

Product code MTS-SFP-1G-..	Mode <sup>a</sup>	Wave length	F/O cable length example <sup>b</sup>	Optical attenuation	BLPc/dispersion
-TX/RJ45...	TX/RJ45	Full Duplex Negotiation	100 m	-	-
-SX/LC...	MM	850 nm	550 m (> 8 dB link budget at 850 nm)	3.0 dB/km	-
-LX/LC...	SM	1310 nm	20 km (> 15 dB link budget at 1310 nm)	0.32 dB/km	-
-LX+/LC...	SM	1310 nm	40 km (> 22 dB link budget at 1310 nm)	0.32 dB/km	-
-LH/LC...	SM	1550 nm	80 km (> 22 dB link budget at 1550 nm)	0.18 dB/km	18 ps/(nmxkm)
-LH+/LC	SM	1550 nm	120 km (> 32 dB link budget at 1550 nm)	0.18 dB/km	18 ps/(nmxkm)
-BIDI-TypeA-LX/LC...	SM	TX1310 nm RX1550 nm	10 km (> 14 dB link budget at 1310/1550 nm)	0.18 dB/km	18 ps/(nmxkm)
-BIDI-TypeB-LX/LC...	SM	TX1550 nm RX1310 nm	10 km (< 14 dB link budget at 1550/1310 nm)	0.32 dB/km	-
-LX+/LC-1550...	SM	1550 nm	40 km (> 19 dB link budget at 1550 nm)	0.18 dB/km	-

*Table 3: Fiber port 1G SFP module*

- a. MM =multi-module, SM =simple module, LH =single mode long haul  
b. When optical fiber data is observed, it includes 3dB system reserve

Product code MTS-SFP-10G-...	Mode <sup>a</sup>	Wave length	F/O cable length example <sup>b</sup>	Optical attenuation	BLPc/dispersion
-SR/LC...	MM	850 nm	300 m (> 5.1 dB link budget at 850 nm )	3.0 dB/km	-
-LR/LC...	SM	1310 nm	10 km (> 6.6 dB link budget at 1310 nm)	0.32 dB/km	-
-ER/LC...	SM	1550 nm	40 km (> 15 dB link budget at 1550 nm)	0.18 dB/km	18 ps/(nmxk m)
-TX/RJ45...	TX/RJ45	Full Duplex Negotiation	30 m	-	-

*Table 4: Fiber port 10G SFP module*

- a. MM =multi-module, SM =simple module  
b. When optical fiber data is observed, it includes 3dB system reserve

## 7.6 Power consumption/power output

Name	Maximum power consumption	Power output
<b>Basic device</b>		
MTS2624-4X-B	26 W	91 Btu (IT)/h
MTS2648-6X-B	75 W	256 Btu (IT)/h
MTS2724-4X-FP-S	29 W	101.5 Btu (IT)/h
MTS2724-6X-MP-E	34 W	119 Btu (IT)/h
MTS2748-6X-MP-E	46 W	161 Btu (IT)/h
MTS2832TF-4X-E	60 W	210 Btu (IT)/h
MTS2824F-4X-S	38 W	133 Btu (IT)/h
MTS2824-4X-S	26 W	91 Btu (IT)/h
MTS2848-6X-S	55 W	192.5 Btu (IT)/h
MTS2824-6X-E	37 W	129.5 Btu (IT)/h
MTS2848-6X-E	55 W	192.5 Btu (IT)/h
MTS2848TF-4X-E	49 W	167 Btu (IT)/h

Name	Maximum power consumption	Power output
<b>1G SFP+</b>		
MTS-SFP-1G-BIDI-TypeA-LX/LC	< 1 W	< 3.5 Btu (IT)/h
MTS-SFP-1G-BIDI-TypeB-LX/LC	< 1 W	< 3.5 Btu (IT)/h
MTS-SFP-1G-LH+/LC	< 1 W	< 3.5 Btu (IT)/h
MTS-SFP-1G-LH/LC	< 1 W	< 3.5 Btu (IT)/h
MTS-SFP-1G-LX+/LC	< 1 W	< 3.5 Btu (IT)/h
MTS-SFP-1G-LX+/LC-1550	< 1 W	< 3.5 Btu (IT)/h
MTS-SFP-1G-LX/LC	< 1 W	< 3.5 Btu (IT)/h
MTS-SFP-1G-SX/LC	< 1 W	< 3.5 Btu (IT)/h
MTS-SFP-1G-TX/RJ45	< 1 W	< 3.5 Btu (IT)/h

Name	Maximum power consumption	Power output
<b>10G SFP+</b>		
MTS-SFP-10G-ER-LC	< 1 W	< 3.5 Btu (IT)/h
MTS-SFP-10G-LR/LC	< 1 W	< 3.5 Btu (IT)/h
MTS-SFP-10G-SR/LC	< 1 W	< 3.5 Btu (IT)/h
MTS-SFP-10G-TX/RJ45	< 1 W	< 3.5 Btu (IT)/h

## 7 Scope of delivery, order number, and accessories

### ■ Delivery item

Quantity	Articles
1x	Device
1x	Safety and general information sheet
2x	Bracket

### ■ Order number

MTS2624-4X-B	942 999-847
MTS2648-6X-B	942 999-839
MTS2748-6X-MP-E	942 999-831
MTS2724-6X-MP-E	942 999-832
MTS2700-PU880	942 999-837
MTM2700-PSU500	942 999-833
MTM2700-PSU120	942 999-834
MTS2724-4X-FP-S	942 999-835
MTM2700-2X	942 999-836
MTS2848-6X-E	942 999-841
MTS2848TF-4X-E	942 999-849
MTM2800-PSU120	942 999-840
MTM2800-2X	942 999-850
MTS2824-6X-E	942 999-842
MTS2848-6X-S	942 999-843
MTS2824-4X-S	942 999-844
MTS2824F-4X-S	942 999-845
MTS2832TF-4X-E	942 999-846

### ■ Accessories

Note the fact that the products used as accessories may have different characteristics from the device itself limits the influence sphere of the whole system. For example, if you apply IP20 accessory to IP65 equipment, the entire system will be reduced to IP20.

1G SFP module	Order number
MTS-SFP-1G-TX/RJ45	942 999-854
MTS-SFP-1G-SX/LC	942 999-855
MTS-SFP-1G-LX/LC	942 999-856
MTS-SFP-1G-LX+/LC	942 999-857
MTS-SFP-1G-LH/LC	942 999-858
MTS-SFP-1G-LH+/LC	942 999-859
MTS-SFP-1G-BIDI-TypeA-LX/LC	942 999-860

MTS-SFP-1G-BIDI-TypeB-LX/LC	942 999-861
MTS-SFP-1G-LX+/LC-1550	942 999-862
<b>10G SFP module</b>	<b>Order number</b>
MTS-SFP-10G-SR/LC	942 999-851
MTS-SFP-10G-LR/LC	942 999-852
MTS-SFP-10G-ER/LC	942 999-853
MTS-SFP-10G-TX/RJ45	942 999-867

You may access more information about certificates here:

<https://catalog.belden.com>

## 8 Underlying technical standards

Name	
FCC 47CFR Part 15	Code of Federal Regulations
IEC 60825-1	Safety of Laser Products
EN 55032	Electromagnetic compatibility of multimedia equipment. Emission Requirements
EN 55035	Electromagnetic compatibility of multimedia equipment. Immunity Requirements
EN 62368-1	Information technology equipment - Safety - Part 1: General requirements
EN 61000-3-2	Electromagnetic compatibility (EMC) - Part 3-2: Threshold - Threshold for harmonic current (equipment input current $\leq 16$ A per phase)
EN 61000-3-3	Electromagnetic compatibility (EMC) - Part 3-3: Threshold - Limitation of voltage changes, voltage fluctuations and flicker in public low-voltage supply systems, for equipment with rated current $\leq 16$ A per phase and not subject to conditional connection
EN 61000-6-2	Electromagnetic compatibility (EMC)- Part 6-2: Generic standards - Immunity for industrial environments
EN 61000-6-4	Electromagnetic compatibility (EMC) - Part 6-4: Generic standards - Emission standard for industrial environments
EN 61131-2	Programmable controllers - Part 2: Equipment requirements and tests

*Table 5: List of technical standards*

The device generally fulfills the technical standards named in their current versions.

Only when the device shell has the certification mark, it means that the device is certified to a specific standard.

# **A Further support**

## **Technical questions**

For technical questions, please contact any Hirschmann IT dealer in your area or Hirschmann IT directly.

A list of local telephone numbers and email addresses for technical support directly from Hirschmann IT is available at,  
<https://hirschmann-it-support.belden.com>

This site also includes a free of charge knowledge base and a software download section.

# HIRSCHMANN IT

---

A **BELDEN** BRAND